

Aspire 5820T Series Service Guide

Service guide files and updates are available on the ACER/CSD web; for more information, please refer to <http://csd.acer.com.tw>

PRINTED IN TAIWAN

Revision History

Please refer to the table below for the updates made on this service guide.

Date	Chapter	Updates

Copyright

Copyright © 2010 by Acer Incorporated. All rights reserved. No part of this publication may be reproduced, transmitted, transcribed, stored in a retrieval system, or translated into any language or computer language, in any form or by any means, electronic, mechanical, magnetic, optical, chemical, manual or otherwise, without the prior written permission of Acer Incorporated.

Disclaimer

The information in this guide is subject to change without notice.

Acer Incorporated makes no representations or warranties, either expressed or implied, with respect to the contents hereof and specifically disclaims any warranties of merchantability or fitness for any particular purpose. Any Acer Incorporated software described in this manual is sold or licensed "as is". Should the programs prove defective following their purchase, the buyer (and not Acer Incorporated, its distributor, or its dealer) assumes the entire cost of all necessary servicing, repair, and any incidental or consequential damages resulting from any defect in the software.

Acer is a registered trademark of Acer Corporation.

Intel is a registered trademark of Intel Corporation.

Other brand and product names are trademarks and/or registered trademarks of their respective holders.

Conventions

The following conventions are used in this manual:

SCREEN MESSAGES	Denotes actual messages that appear on screen.
NOTE	Gives bits and pieces of additional information related to the current topic.
WARNING	Alerts you to any damage that might result from doing or not doing specific actions.
CAUTION	Gives precautionary measures to avoid possible hardware or software problems.
IMPORTANT	Reminds you to do specific actions relevant to the accomplishment of procedures.



NOTE: This symbol where placed in the Service Guide designates a component that should be recycled according to the local regulations.

Preface

Before using this information and the product it supports, please read the following general information.

1. This Service Guide provides you with all technical information relating to the BASIC CONFIGURATION decided for Acer's "global" product offering. To better fit local market requirements and enhance product competitiveness, your regional office MAY have decided to extend the functionality of a machine (e.g. add-on card, modem, or extra memory capability). These LOCALIZED FEATURES will NOT be covered in this generic service guide. In such cases, please contact your regional offices or the responsible personnel/channel to provide you with further technical details.
2. Please note WHEN ORDERING FRU PARTS, that you should check the most up-to-date information available on your regional web or channel. If, for whatever reason, a part number change is made, it will not be noted in the printed Service Guide. For ACER-AUTHORIZED SERVICE PROVIDERS, your Acer office may have a DIFFERENT part number code to those given in the FRU list of this printed Service Guide. You MUST use the list provided by your regional Acer office to order FRU parts for repair and service of customer machines.

System Specifications	1
Features	1
System Block Diagram	5
Notebook Tour	6
Top View	6
Closed Front View	7
Left View	7
Right View	8
Base View	9
Indicators	9
TouchPad Basics	10
Using the Keyboard	11
Lock Keys and embedded numeric keypad	11
Windows Keys	12
Hot Keys	13
Special Keys	14
Hardware Specifications and Configurations	15
 System Utilities	 23
BIOS Setup Utility	23
Navigating the BIOS Utility	23
Information	24
Main	25
Security	26
Boot	29
Exit	30
BIOS Flash Utility	31
DOS Flash Utility	32
WinFlash Utility	33
Remove HDD/BIOS Password Utilities	34
Removing BIOS Passwords:	35
Miscellaneous Utilities	36
 Machine Disassembly and Replacement	 39
Disassembly Requirements	39
Related Information	39
Replacement Requirements	39
Pre-disassembly Instructions	40
Disassembly Process	41
External Module Disassembly Process	42
External Modules Disassembly Flowchart	42
Removing the Battery Pack	43
Removing the Dummy Card	44
Removing the SIM Card	45
Removing the Base Door	46
Removing the Hard Disk Drive Module	48
Removing the DIMM Module	50
Removing the WLAN Module	51
Removing the 3G Module	53
Removing the ODD Module	55
Removing the RTC Battery	57
Main Unit Disassembly Process	58
Main Unit Disassembly Flowchart	59
Removing the Keyboard	61

Table of Contents

Removing the Upper Cover	63
Removing the Switch Board	67
Removing the Power Board	69
Removing the LCD Module	71
Removing the I/O Board	76
Removing the Bluetooth Module	78
Removing the Mainboard	80
Removing the Thermal Module	82
Removing the CPU	83
Removing the PCH Thermal Unit	84
Removing the Power Cable Assembly	85
LCD Module Disassembly Process	87
LCD Module Disassembly Flowchart	87
Removing the LCD Bezel	89
Removing the Camera Board	91
Removing the LCD Panel	92
Removing the Antennas	95
Removing the Microphone Cable	98
LCD Reassembly Procedure	99
Replacing the Microphone	99
Replacing the Antennas	99
Replacing the LCD FPC Cable	103
Replacing the LCD Panel	104
Replacing the Camera Board	106
Replacing the LCD Bezel	107
Main Unit Reassembly Process	110
Replacing the Power Assembly	110
Replacing the PCH Thermal Module	112
Replacing the CPU	112
Replacing the Thermal Module	114
Replacing the Main Board	115
Replacing the I/O Card	116
Replacing the Bluetooth Module	118
Replacing the LCD Module	120
Replacing the Power Board	124
Replacing the Switch Board	125
Replacing the Upper Cover	126
Replacing the Keyboard	130
Replacing the Wireless LAN Module	131
Replacing the 3G Module	133
Replacing the DIMM Module	135
Replacing the Hard Disk Drive	136
Replacing the RTC Battery	138
Replacing the ODD Module	139
Replacing the Base Door	141
Replacing the SIM Card	142
Replacing the Battery	142
Replace the Dummy Card	143

Troubleshooting

145

Common Problems	145
Power On Issue	146
No Display Issue	147
Random Loss of BIOS Settings	148
LCD Failure	149

Table of Contents

Built-In Keyboard Failure	150
TouchPad Failure	151
Internal Speaker Failure	152
Internal Microphone Failure	153
HDD Not Operating Correctly	154
USB Failure (Right up/down side)	155
Other Failures	155
Intermittent Problems	156
Undetermined Problems	156
Post Code Reference Tables	157
Jumper and Connector Locations	163
Mainboard Top View	163
Mainboard Bottom View	164
BIOS Recovery	165
BIOS Recovery by Crisis Disk	165
FRU (Field Replaceable Unit) List	167
Exploded Diagrams	168
Main Assembly	168
LCD Assembly	170
FRU List	171
Screw Table	179
Model Definition and Configuration	181
Test Compatible Components	251
Online Support Information	255

Table of Contents

System Specifications

Features

Below is a brief summary of the computer's many features:

Operating System

- Genuine Windows® 7 Home Basic 64-bit
- Genuine Windows® 7 Home Premium 64-bit

Platform

- Intel® Core™ i7-620M processor (4 MB L3 cache, 2.66 GHz with Turbo Boost up to 3.33 GHz, DDR3 1066 MHz, 35 W), supporting Intel® 64 architecture, Intel® Smart Cache
- Intel® Core i5-430M/i5-520M/i5-540M processor (3 MB L3 cache, 2.26/2.40/2.53 GHz with Turbo Boost up to 2.53/2.93/3.06 GHz, DDR3 1066 MHz, 35 W), supporting Intel® 64 architecture, Intel® Smart Cache
- Intel® Core i3-330M/i3-350M processor (3 MB L3 cache, 2.13/2.26 GHz, DDR3 1066 MHz, 35 W), supporting Intel® 64 architecture, Intel® Smart Cache

System Memory

- Dual-channel DDR3 SDRAM support:
 - Up to 4 GB of DDR3 1066 MHz memory, upgradeable to 8 GB using two soDIMM modules (for 64-bit OS)

Display

- 15" HD 1366 x 768 pixel resolution, high-brightness (200-nit) Acer CineCrystal™ LED-backlit TFT LCD, supporting simultaneous multi-window viewing via Acer GridVista™
- Mercury free, environment friendly
- 16:9 aspect ratio
- Super-slim design

Graphics

- Intel® HD Graphics with 128 MB of dedicated system memory, supporting Microsoft® DirectX® 10
- Dual independent display support
- 16.7 million colors
- External resolution / refresh rates:
 - VGA port up to 2560 x 1600: 60 Hz
 - HDMI™ port up to 1920 x 1200: 60 Hz
- MPEG-2/DVD decoding WMV9 VC-1 and H.264 (AVC) decoding
- HDMI™ (High-Definition Multimedia Interface) with HDCP (High-bandwidth Digital Content Protection) support

Storage subsystem

- 160/250/320/500/640 GB or larger hard disk drive
- Multi-in-1 card reader, supporting Secure Digital™ (SD), MultiMediaCard (MMC), Memory Stick® (MS), Memory Stick PRO™ (MS PRO), xD-Picture Card™ (xD)

Audio subsystem

- Optimized 3rd Generation Dolby® Home Theater®6 audio enhancement, featuring Dolby® Digital Live, Dolby® Pro Logic® IIx, Dolby® Headphone, Dolby® Natural Bass, Dolby® Sound Space Expander, Dolby® Inverse Filtering, Dolby® High Frequency Enhancer technologies
- High-definition audio support
- S/PDIF (Sony/Philips Digital Interface) support for digital speakers
- MS-Sound compatible
- Built-in microphone

Optical Media Drive

- 8X DVD-Super Multi double-layer drive:
 - Read: 24X CD-ROM, 24X CD-R, 24X CD-RW, 8X DVD-ROM, 8X DVD-R, 8X DVD+R, 6X DVD-ROM DL, 6X DVD-R DL, 6X DVD+R DL, 6X DVD-RW, 6X DVD+RW, 5X DVD-RAM
 - Write: 24X CD-R, 16X CD-RW, 8X DVD-R, 8X DVD+R, 4X DVD-R DL, 4X DVD+R DL, 6X DVD-RW, 8X DVD+RW, 5X DVD-RAM

Communication

- Acer Video Conference, featuring:
 - Acer Crystal Eye high-def webcam with 1280 x 1024 resolution
- WLAN:
 - Acer InViLink™ Nplify™ 802.11 b/g/n Wi-Fi CERTIFIED™
 - Acer InViLink™ 802.11b/g Wi-Fi CERTIFIED™
- WPAN: Bluetooth® 2.1+EDR
- WWAN: UMTS/HSPA at 850/900/1900/2100 MHz and quad-band GSM/GPRS/EDGE(850/900/1800/1900 MHz), upgradeable to 7.2 Mb/s HSDPA and 5.7 Mb/s HSUPA, supporting receiver diversity and equalizing at 2100 MHz
- LAN: Gigabit Ethernet, Wake-on-LAN ready

Privacy control

- BIOS user, supervisor, HDD passwords
- Kensington lock slot

Dimensions and Weight

- 379 (W) x 250 (D) x 21.7/29.8 (H) mm (14.96 X 9.84 X 0.83/1.18 inches)
- 2.42 kg (5.40 lbs.) with 6-cell battery

Power Adapter and Battery

- ACPI 3.0 CPU power management standard: supports Stand-by and Hibernation power-saving modes

-
- Acer PowerSmart 3-pin 65 W AC adapter
 - 95 (W) x 50 (D) x 25.4 (H) mm (3.74 x 1.96 x 1 inches)
 - 216 g (0.47 lbs)13 with 180 cm DC cable
 - 66.6 W 6000 mAh 6-cell Li-ion standard battery pack
 - Estimated battery life: Up to 8 hours
 - ENERGY STAR®

Special Keys and Controls

- 103-/104-/107-key keyboard, with inverted "T" cursor layout
- 10 function keys, four cursor keys, two Windows® keys, hotkey controls, independent standard numeric keypad, international language support
- Media control keys (printed on keyboard): play/pause, stop, previous, next
- Multi-gesture touchpad, supporting two-finger scroll, pinch, rotate, flip

I/O Ports

- Multi-in-1 card reader (SD™, MMC, MS, MS PRO, xD)
- Four USB 2.0 ports
- HDMI™ port with HDCP support
- External display (VGA) port
- Headphone/speaker/line-out jack with S/PDIF support
- Microphone-in jack
- Ethernet (RJ-45) port
- DC-in jack for AC adapter

Software

- Productivity
 - Acer Backup Manager
 - Acer ePower Management
 - Acer eRecovery Management
 - Microsoft® Office Trial (Service Pack 2)
 - Microsoft® Works SE 9
 - Microsoft® Works 9
 - Microsoft® Works 8.5
 - Adobe® Flash® Player 10
 - Adobe® Reader® 9.1
 - eSobi™
 - Google™ Setup
 - Google Toolbar™
 - Norton™ Online Backup
- Security
 - Acer Arcade™ Deluxe
 - Acer InstantOn Arcade

-
- McAfee® Internet Security Suite 2009 Trial
 - McAfee® Virus Definitions
 - MyWinLocker®
 - Multimedia
 - Cyberlink® PowerDVD™
 - NTI Media Maker™
 - Gaming
 - Oberon GameZone Acer Edition
 - WildTangent® Acer Edition
 - Communication and ISP
 - Acer Video Conference Manager
 - Microsoft® Silverlight™
 - Windows Live™ Essentials - Wave 3.2 (Mail, Photo Gallery, Live™ Messenger, Movie Maker, Writer)
 - Utilities and tools
 - Acer Accessory Store
 - Acer Assist
 - Acer Identity Card
 - Acer Registration
 - Acer Updater
 - eBay® shortcut 2009
 - Netflix shortcut

Optional Items

- 1 GB / 2 GB / 4 GB DDR3 1066 MHz soDIMM module
- 6-cell Li-ion battery pack
- 9-cell Li-ion battery pack
- 3-pin 65W AC adapter
- External USB floppy disk drive
- External USB Lite+LSI modem

Warranty

- One-year International Travelers Warranty (ITW)

Environment

- Temperature:
 - Operating: 5°C to 35°C
 - Non-operating: -20°C to 65°C
- Humidity (non-condensing):
 - Operating: 20% to 80%
 - Non-operating: 20% to 80%

NOTE: The specifications listed above are for reference only. The exact configuration of the PC depends on the model purchased.

System Block Diagram

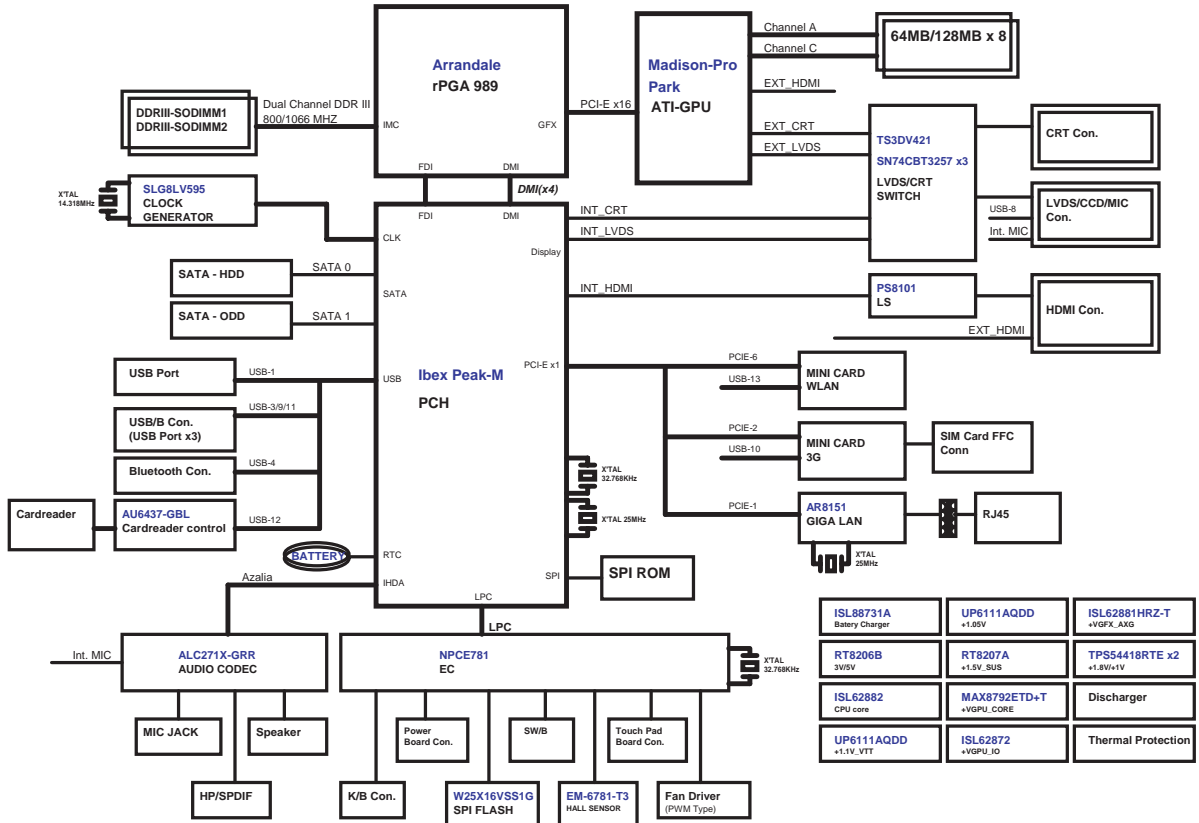







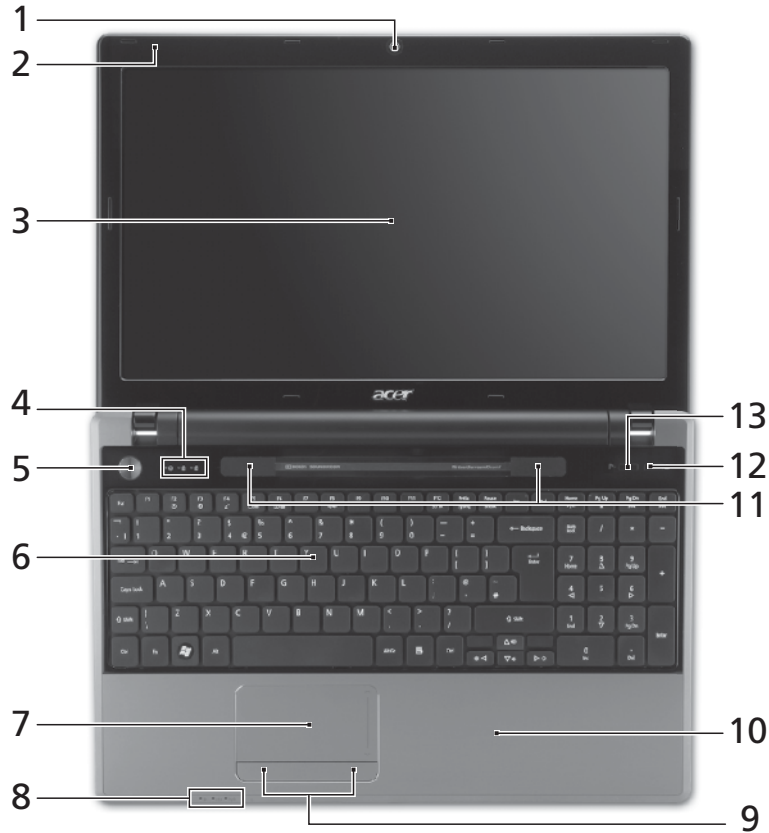



Notebook Tour

This section provides an overview of the features and functions of the notebook.

Top View



#	Icon	Item	Description
1		Acer Crystal Eye webcam	Web camera for video communication. (only for certain models)
2		Microphone	Internal microphone for recording sound.
3		Display screen	Also called Liquid-Crystal Display (LCD), displays computer output (configuration may vary by model).
4		HDD indicator	Indicates when the HDD is active.
		Num Lock indicator	Lights up when the Num Lock is activated.
		Caps Lock indicator	Lights up when the Caps Lock is activated.
5		Power button/	Turns the computer on and off.
6		Keyboard	For entering data into your computer
7		Touchpad	Touch-sensitive pointing device which functions like a computer mouse.

#	Icon	Item	Description
8		Power	Indicates the computer's power status.
		Battery	Indicates the computer's battery status. 1. Charging: The light shows amber when the light is charging. 2. Fully charged: the light shows blue when in AC mode.
		Communication indicator	Indicates the computer's wireless connectivity status.
9		Click buttons (left, and right)	The left and right buttons function like the left and right mouse buttons.
10		Palmrest	Comfortable support area for your hand when using the computer.
11		Speakers	Left and right speakers deliver stereo audio output.
12		Optical drive eject button	Ejects the optical disk from the drive.
13		Programmable key	User-programmable. (only for certain models)
		PowerSmart key	Puts your computer into power-saving mode. (only for certain models)

Closed Front View





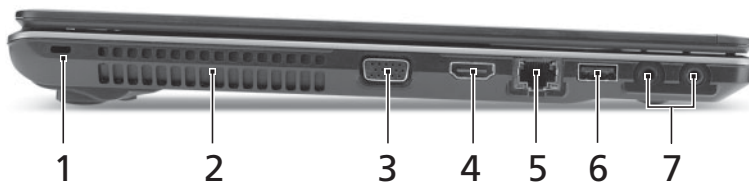

#	Icon	Item	Description
1		Multi-in-1 card reader	Accepts Secure Digital (SD), MultiMediaCard (MMC), Memory Stick (MS), Memory Stick PRO (MS PRO), xD-Picture Card (xD). Note: Push to remove/install the card. Only one card can operate at any given time.

Left View





#	Icon	Item	Description
1		Kensington lock slot	Connects to a Kensington-compatible computer security lock.
2		Ventilation slots	Enable the computer to stay cool, even after prolonged use.

#	Icon	Item	Description
3		External display (VGA) port	Connects to a display device (e.g. external, LCD monitor, LCD projector).
4	HDMI	HDMI port	Supports high definition digital video connections.
5		Ethernet RJ-45) port	Connects to an Ethernet 10/100/1000-based network.
6		USB 2.0 port	Connects to USB 2.0 devices (e.g., USB mouse, USB camera).
7		Microphone jack	Accepts inputs from external microphones.
		Headphones/speaker/line-out jack with S/PDIF support.	Connects to audio line-out devices (e.g., speakers, headphones).

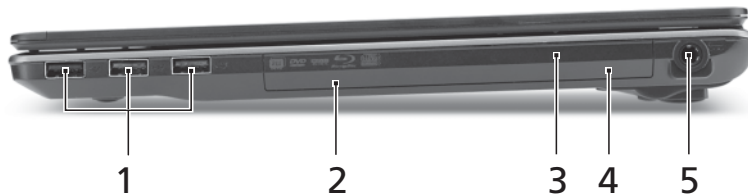



Right View

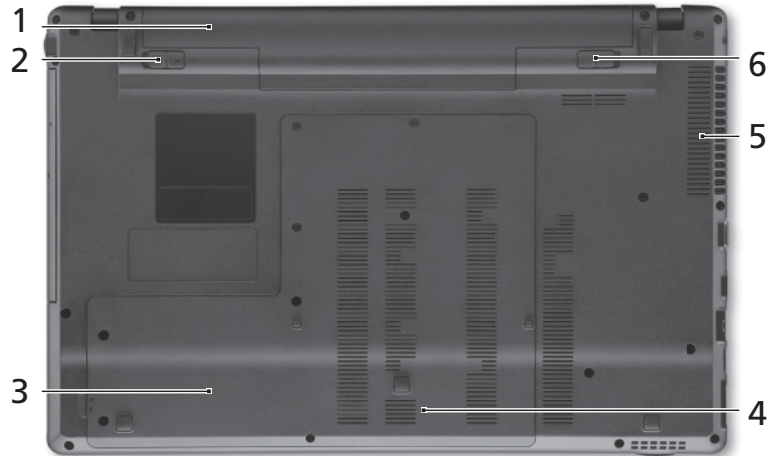

#	Icon	Item	Description
1		USB 2.0 port	Connects to USB 2.0 devices (e.g., USB mouse, USB camera).
2		Optical drive	Internal optical drive; accepts CDs or DVDs.
3		Optical disk access indicator	Lights up when the optical drive is active.
4		Emergency eject hole	Ejects the optical drive tray when the computer is turned off. Note: Insert a paper clip to the emergency eject hole to eject the optical drive tray when the computer is off.
5		DC-in jack	Connects to an AC adapter.







Base View



#	Icon	Item	Description
1		Battery bay	Houses the computer's battery pack. Note: The battery shown is for reference only. Your PC may have a different battery depending on the model purchased.
2		Battery lock	Locks the battery in position
3		Hard disk bay	Houses the computer's hard disk (secured with screws)
4		Memory compartment	Houses the computer's main memory.
5		Ventilation slots and cooling fan	Enable the computer to stay cool, even after prolonged use. Note: Do not cover or obstruct the opening the fan.
6		Battery release latch	Releases the battery for removal.

Indicators

The computer has several easy-to-read status indicators. The battery indicator is visible even when the computer cover is closed.

Icon	Function	Description
	Power	Indicates the computer is on or off.
	Battery	Indicates the computer's battery status.
	Wireless LAN	Indicates the status of Wireless LAN communication.
	HDD	Indicates when the hard disk drive is active.
	Num Lock	Lights up when Num Lock is activated.
	Caps Lock	Lights up when Caps Lock is activated.

NOTE: 1. Charging: The battery light shows amber when the battery is charging. 2. **Fully charged:** The light shows green when in AC mode.

TouchPad Basics

The following items show you how to use the TouchPad:

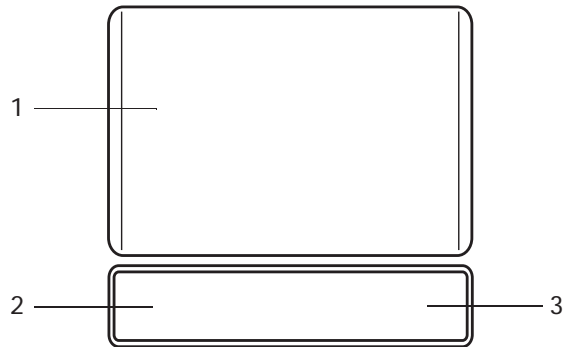

- Move your finger across the TouchPad (1) to move the cursor.
- Press the left (2) and right (3) buttons located beneath the TouchPad to perform selection and execution functions. These two buttons are the equivalent of the left and right buttons on a mouse. Tapping on the TouchPad is the same as clicking the left button.

Function	Left Button (2)	Right Button (3)	Main TouchPad (1)
Execute	Quickly click twice.		Tap twice (at the same speed as double-clicking a mouse button).
Select	Click once.		Tap once.
Drag	Click and hold, then use finger on the TouchPad to drag the cursor.		Tap twice (at the same speed as double-clicking a mouse button); rest your finger on the TouchPad on the second tap and drag the cursor.
Access context menu		Click once.	

NOTE: When using the TouchPad, keep it - and your fingers - dry and clean. The TouchPad is sensitive to finger movement; hence, the lighter the touch, the better the response. Tapping too hard will not increase the TouchPad's responsiveness.

Using the Keyboard

Your computer has a close-to-full-sized keyboard and an embedded numeric keypad, separate cursor, lock, function and special keys.

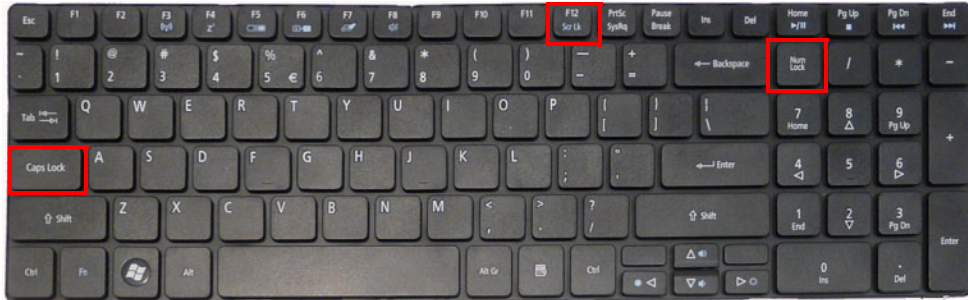

Lock Keys and embedded numeric keypad

The keyboard has three lock keys which you can toggle on and off.













Lock key	Description
Caps Lock	When Caps Lock is on, all alphabetic characters typed are in uppercase.
Num Lock	When Num Lock is on, the embedded keypad is in numeric mode. The keys function as a calculator (complete with the arithmetic operators +, -, *, and /). Use this mode when you need to do a lot of numeric data entry. A better solution would be to connect an external keypad.
Scroll Lock <Fn> + <F12>	When Scroll Lock is on, the screen moves one line up or down when you press the up or down arrow keys respectively. Scroll Lock does not work with some applications.

The embedded numeric keypad functions like a desktop numeric keypad. It is indicated by small characters located on the upper right corner of the keycaps. To simplify the keyboard legend, cursor-control key symbols are not printed on the keys.

Desired access	Num Lock on	Num Lock off
Number keys on embedded keypad	Type numbers in a normal manner.	
Cursor-control keys on embedded keypad	Hold <Shift> while using cursor-control keys.	Hold <Fn> while using cursor-control keys.
Main keyboard keys	Hold <Fn> while typing letters on embedded keypad.	Type the letters in a normal manner.

Windows Keys

The keyboard has two keys that perform Windows-specific functions.

Key	Description
 Windows key	<p>Pressed alone, this key has the same effect as clicking on the Windows Start button; it launches the Start menu. It can also be used with other keys to provide a variety of functions:</p> <ul style="list-style-type: none"><  >: Open or close the Start menu<  > + <D>: Display the desktop<  > + <E>: Open Windows Explore<  > + <F>: Search for a file or folder<  > + <L>: Lock your computer (if you are connected to a network domain), or switch users (if you're not connected to a network domain)<  > + <M>: Minimizes all windows<  > + <R>: Open the Run dialog box<  > + <U>: Open Ease of Access Center<  > + <BREAK>: Display the System Properties dialog box<  > + <TAB>: Cycle through programs on the taskbar<CTRL> + <  > + <F>: Search for computers (if you are on a network) <p>Note: Depending on your edition of Windows 7, some shortcuts may not function as described.</p>
 Application key	This key has the same effect as clicking the right mouse button; it opens the application's context menu.

Hot Keys

The computer employs hotkeys or key combinations to access most of the computer's controls like screen brightness and volume output.

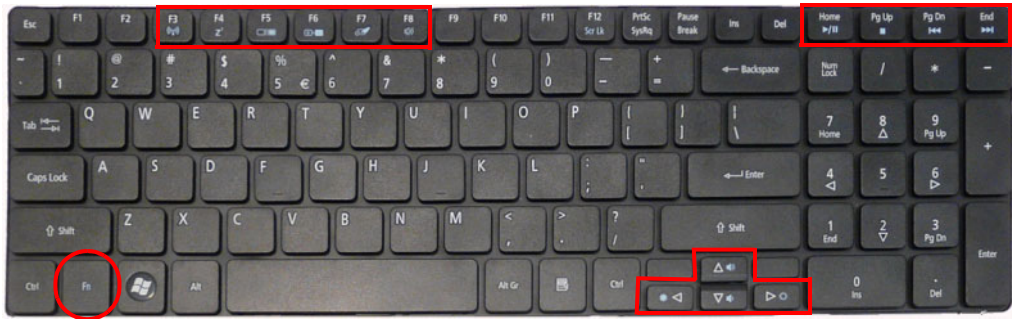

To activate hotkeys, press and hold the <Fn> key before pressing the other key in the hotkey combination.

Hotkey	Icon	Function	Description
<Fn> + <F3>		Wireless communication switch	Enables/disables the Wireless function.
<Fn> + <F4>		Sleep	Puts the computer in Sleep mode.
<Fn> + <F5>		Display toggle	Switches display output between the display screen, external monitor (if connected) and both.
<Fn> + <F6>		Screen blank	Turns the display screen backlight off to save power. Press any key to return.
<Fn> + <F7>		Touchpad toggle	Turns the touchpad on and off.
<Fn> + <F8>		Speaker toggle	Turns the speakers on and off.
<Fn> + <Δ>		Brightness up	Increases the screen brightness.
<Fn> + <◁>		Brightness down	Decreases the screen brightness.
<Fn> + <Δ>		Volume up	Increases the sound volume.
<Fn> + <▽>		Volume down	Decreases the sound volume.
<Fn> + <Home>		Play/Pause	Plays or pauses media files
<Fn> + <Pg Up>		Stop	Stops media file
<Fn> + <Pg Dn>		Previous	Plays the previous media file in the play sequence
<Fn> + <End>		Next	Plays the next media file in the play sequence

Special Keys

On models that support the Euro symbol and the US dollar sign, the symbols can be located at the upper-center and/or bottom-right of your keyboard.

The Euro symbol

1. Open a text editor or word processor.
2. Hold <Alt Gr> and then press the <5> key at the upper-center of the keyboard.

NOTE: Some fonts and software do not support the Euro symbol. See www.microsoft.com/typography/faq/faq12.htm for more information.

The US dollar sign

1. Open a text editor or word processor.
2. Hold <Shift> and then press the <4> key at the upper-center of the keyboard.

NOTE: This function varies according to the language settings.

Hardware Specifications and Configurations

Processor

Item	Specification
CPU	<ul style="list-style-type: none"> Intel Calpella (Discrete/UMA: Arrandale with Gfx) Intel PCH: HM55 (4MB SPI ROM)
Type	<ul style="list-style-type: none"> MCP (Multi-Chip Package) CPU
CPU Package	989 pins-rPGA socket
Power	65 Watts
On-die Cache	<ul style="list-style-type: none"> 32-KB instruction and 32 -KB data first-level cache (L1) for each core 256-KB shared instruction/data second -level cache (L2) for each core Up to 8-MB shared instruction/data last -level cache (L3), shared among all cores
Front Side Bus	800/1066M/1333Hz

Processor Specifications

Item	CPU Speed	Cores	Bus Speed	Cache Size	Package	Core Voltage
Ci3330M	2.13	2	330 M	3 MB	PGA988	35W
Ci5430M	2.26	2	430 M	3 MB	PGA988	35W
Ci5520M	2.24	2	520 M	3 MB	PGA988P	35W
Ci7620M	2.66	2	620 M	4 MB	PGA988P	35W

CPU Fan True Value Table (UMA)

CPU Temperature (Celsius)	Fan Speed (RPM)	SPL Spec (dBA)
45	2500	31
55	3100	34
65	3500	38
75	3900	40
85	4200	42

Throttling 50%: On= 100°C; OFF=85°C

OS shut down at 105°C; H/W shut down at 110°C

CPU Fan True Value Table (Discrete)

CPU Temperature (Celsius)	Fan Speed (RPM)	SPL Spec (dBA)
40	2500	31
50	3100	34
60	3500	38
70	3900	40
80	4200	42

Throttling 50%: On= 100°C; OFF=85°C

OS shut down at 105°C; H/W shut down at 110°C

Core Logic Specifications

Item	Specification
Chipset	Intel Ibex-Peak (HM55)
Package	1071-pins FCBGA 27mm x 25mm
Features	<ul style="list-style-type: none"> • PCI Express* Base Specification, Revision 2.0 support for up to eight ports. • PCI Local Bus Specification, Revision 2.3 support for 33 MHz PCI operations (supports up to four Req/Gnt pairs). • ACPI Power Management Logic Support, Revision 3.0b • Enhanced DMA controller, interrupt controller, and timer functions • Integrated Serial ATA host controllers with independent DMA operation on up to six ports. • FIS-based Port Multiplier support on SATA Ports 4 and 5 in AHCI/RAID mode. • USB host interface with support for up to twelve USB ports; two EHCI high -speed USB 2.0 Host controllers, 2 rate matching hubs, six UHCI host controllers; • System Management Bus (SMBus) Specification, Version 2.0 with additional support for I2C devices • Supports Intel High Definition Audio • Supports Intel Matrix Storage Technology • Supports Intel Active Management Technology • Supports Intel Virtualization Technology for Directed I/O • Supports Intel Trusted Execution Technology • Supports buffered through mode generating extra clocks from a clock chip. • Analog and Digital Display ports <ul style="list-style-type: none"> • Analog CRT • HDMI • DisplayPort 1.1 (dGPU only) • LVDS • Low Pin Count (LPC) interface • Serial Peripheral Interface (SPI) support • Intel Anti-Theft Technology • JTAG Boundary Scan support

System Memory

Item	Specification
Memory size	0MB (No on-board Memory)
DIMM socket number	2 sockets
Supports memory size per socket	4GB
Supports maximum memory size	8GB
Supports DIMM type	DDR3
Supports DIMM Speed	1066/1333 MHz

Video Specifications

Item	Specification	
Chipset	VGA chip Build-in Intel Graphics Media Accelerator HD	AMD Madison-Pro
Type	Arrandale HM55 PCH	
Package		<ul style="list-style-type: none"> 962-pins FCBGA 29mm x 29mm
Features	<ul style="list-style-type: none"> The integrated graphics controller contains a refresh of the 5th generation graphics core. Intel Dynamic Video Memory Technology support Intel Smart 2D Display Technology (Intel S2DDT) Intel Clear Video Technology <ul style="list-style-type: none"> MPEG2 Hardware Acceleration WMV9/VC1 Hardware Acceleration AVC Hardware Acceleration ProcAmp Advanced Pixel Adaptive De-interlacing Sharpness Enhancement De-noise Filter High Quality Scaling Film Mode Detection (3:2 pull -down) and Correction Intel TV Wizard Microsoft DirectX*11 support Analog CRT DAC Interface Support (300MHz DAC/up to QXGA/Hot -Plug) Dual-Channel LVDS interface support 2x24 bpp panels 	<ul style="list-style-type: none"> Fully compliant with PCI Express Base Specification Rev. 2.1 Support CRT/LVDS/HDMI/DP interface (concurrent) Dual-channel LVDS interface support: single channel 24 bpp dual link HDCP compliance embed-in Full POWERPLAYTM 8.0 support LVDS / Engine and Memory / DP Spread Spectrum Support H.264 implementation is based on the ISO/IEC 14496-10 specification. VC-1 implementation is based on the SMPTE 421M specification. MPEG2 implementation is based on the ISO 13818 -2 Supports top quality DVD and Blu - Ray disc with the lowest CPU usage. VDDC (GPU core power supply) VDDCI (GPU I/O power supply) 1V (DP PLL power supply) 1.5V (VRAM and memory control power supply) 1.8V (CRT DAC and LVDS power supply) 3V (Peripheral power supply)

LCD Display Resolution

Resolution	24 bits	30 bits	36 bits	48 bits
640x480p/60Hz 4:3	Yes	Yes	Yes	Yes
720x480p/60Hz 4:3	Yes	Yes	Yes	Yes
720x480p/60Hz 16:9	Yes	Yes	Yes	Yes
1280x720p/60Hz 16:9	Yes	Yes	Yes	Yes
1920x1080i/60Hz 16:9	Yes	Yes	Yes	Yes
1440x480i/60Hz 4:3	Yes	Yes	Yes	Yes

Resolution	24 bits	30 bits	36 bits	48 bits
1440x480i/60Hz 16:9	Yes	Yes	Yes	Yes
1920x1080p/60Hz 16:9	Yes	Yes	Yes	Yes
720x576p/50Hz 4:3	Yes	Yes	Yes	Yes
720x576p/50Hz 16:9	Yes	Yes	Yes	Yes
1280x720p/50Hz 16:9	Yes	Yes	Yes	Yes
1920x1080i/50Hz 16:9	Yes	Yes	Yes	Yes
1440x576i/50Hz 4:3	Yes	Yes	Yes	Yes
1440x576i/50Hz 16:9	Yes	Yes	Yes	Yes
1920x1080p/50Hz 16:9	Yes	Yes	Yes	Yes

Hard Disk Drive Interface

Item	Specification			
Vendor & Model Name	Seagate	HGST	Toshiba	Western Digital
Capacity (GB)	160, 250, 320, 500	160, 250, 320, 500	160, 250, 320, 500	160, 250, 320, 500, 640
Bytes per sector	512			
Data heads	2-4			
Drive Format				
Disks	1-2			
Spindle speed (RPM)	5400			
Performance Specifications				
Buffer size	8 MB			
Interface	SATA			
DC Power Requirements				
Voltage tolerance	5V \pm 5%	5V \pm 5%	5V \pm 5%	5V \pm 5%

BIOS

Item	Specification
BIOS vendor	Insyde BIOS
BIOS version	3.5
BIOS ROM type	Flash

Item	Specification
Features	<ul style="list-style-type: none"> • Flash ROM 4MB • Support ISIPP • Support Acer UI • Support multi-boot • Suspend to RAM (S3)/Disk (S4) • Various hot-keys for system control • Support SMBIOS 2.3, PCI2.2. • Refer to Acer BIOS specification. • DMI utility for BIOS serial number configurable/asset tag • Support PXE • Support Y2K solution • Support WinFlash • Wake on LAN from S3 • Wake on LAN form S4 in AC mode • System information

LCD 15.6"

Item	Specification
Vendor/model name	AUO/Samsung/LG
Screen Diagonal (mm)	15.6 inches
Display resolution (pixels)	1366 x 768
Pixel Pitch	0.252x 0.252
Display Mode	Normally White
Typical White Luminance (cd/m ²) (also called Brightness)	200
Contrast Ratio	500 typical
Response Time (Optical Rise Time/Fall Time) msec	8/16
Luminance Uniformity	1.25 max
Electrical Interface	LVDS
Support Color	262K
Viewing Angle (up/down/right/ left)	15/35/45/45
Temperature Range (°C) Operating Storage (shipping)	0 to +50 -20 to +60

Bluetooth

Item	Specification
Bluetooth Controller	Foxconn Bluetooth BRM 2046 BT2.1 (T60H928.33) F/W:861
Features	<ul style="list-style-type: none"> Fully Qualified Bluetooth v2.1 with Class 2 specification RF output power. Enhanced Data Rate (EDR) compliant. Full Piconet and Scatternet operation. Integrated PIFA Antenna with better RF performance. USB 2.0 compliant interface. F/W upgradable via Flash downloads. Very low power consumption. Support Coexistence with Intel WCS (Wireless Coexistence System) & AFH (Adaptive Frequency Hopping). A2DP support.

Audio Codec and Amplifier

Item	Specification
Audio Controller	Realtek ALC271X-GR
Package	48-pin QFN
Features	<ul style="list-style-type: none"> Compatible with Windows Logo Program 3.10 and future requirements WaveRT-based audio function driver for Windows 7 EAX™ 1.0 & 2.0 compatible Direct Sound 3D™ compatible I3DL2 compatible HRTF 3D Positional Audio (Windows XP only) Emulation of 26 sound environments to enhance gaming experience Multi-band software equalizer and tools Voice Cancellation and Key Shifting in Karaoke mode Dynamic range control (expander, compressor, and limiter) with adjustable parameters Intuitive Configuration Panel (Realtek Audio Manager) to enhance user experience Microphone Acoustic Echo Cancellation (AEC), Noise Suppression (NS), and Beam Forming (BF) technology for voice application Smart multiple streaming operation HDMI audio driver for AMD platform Dolby® PCEE program™ (optional software feature) Fortemedia® SAM™ technology for voice processing (Beam Forming and Acoustic Echo Cancellation) (optional software feature). Acer exclusive software features

LAN Interface

Item	Specification
LAN Chipset	ATHEROS AR8131L
Package	48pin QFN
Features	<ul style="list-style-type: none">The AR8131L is the third generation Gigabit Ethernet (GbE) controller solution from Atheros. It is an ultra-high performance, ultralow cost, and ultra-low power fully integrated 10/100/1000 Mbps NIC/LOM Ethernet controller perfectly suited for both PC and embedded applications.The AR8131L combines a 10/100/1000BASE-T GbE media access controller (MAC), a triplespeed Ethernet physical layer transceiver (PHY), and a PCI Express bus interface.The AR8131L is compliant with IEEE 802.3u specification for 10/100 Mbps Ethernet and IEEE 802.3ab specification for 1000 Mbps Ethernet.The AR8131L device combines pulse shaping, Tx/Rx PCS, echo canceller, NEXT canceller, equalizer, decoder, and timing recovery functions to deliver robust signal performance in noisy environments.The AR8131L GbE controller supports checksum off-load features for IP, TCP, and UDP,

Keyboard

Item	Specification
Type	ACER AC7T_A10B AC7T Internal 17
Total number of keypads	103/104/107
Windows logo key	Yes
Internal & external keyboard work simultaneously	Yes
Features	<ul style="list-style-type: none">Supports application keys for Windows 7 version

Media Card Reader

Item	Specification
Chipset	AU6437-GBL -GR
Package	LQFP
Features	<ul style="list-style-type: none">Fully compatible with USB2.0 High Speed and backward compatible with USB1.1 specificationsSupports multiple flash card interfaces, including SD/ MMC/xD/MS.Supports single LUNSupports both Windows and Mac OS

Camera

Item	Specifications
Vendor and model	SUYIN/ Chicony/ Liteon
Type	CMOS image sensor with WXGA (resolution 1280X800)
Interface	USB Port
Focusing range	26.6cm ~ infinity
Dimensions (L x W x H mm)	65.0±0.3 X 8.0±0.1 X 3.69+0.11/-0.2 mm

Item	Specifications
Sensor type	1.0Mega CMOS Sensor
Pixel resolution	1280X800
Pixel size	3.0um X3.0um
Image size	3.89mm(H) X 2.43mm(V)Part number

Wireless LAN

	Specification	Specification	Specification
Type	Atheros HB95	Atheros HB93	Intel MM#903341
Wireless Standards Supported	b, g	b, g, n	b, n

Battery

Item	Specification
	6 Cell
Vendor & model name	SAMSUNG AS10B
Battery Type	Li-ion
Pack capacity	SAMSUNG 6000mAh
Number of battery cell	6
Package configuration	3 cells in series, 2 series in parallel

System Utilities

BIOS Setup Utility

The BIOS Setup Utility is a hardware configuration program built into your computer's BIOS (Basic Input/Output System).

Your computer is already properly configured and optimized, and you do not need to run this utility. However, if you encounter configuration problems, you may need to run Setup. Please also refer to Chapter 4 Troubleshooting when problem arises.

To activate the BIOS Utility, press **F2** during POST (when **Press <F2> to enter Setup** message is prompted on the bottom of screen).

Press **F2** to enter setup. The default parameter of F12 Boot Menu is set to "disabled". If you want to change boot device without entering BIOS Setup Utility, please set the parameter to "enabled".

Press **<F12>** during POST to enter multi-boot menu. In this menu, user can change boot device without entering BIOS SETUP Utility.

Navigating the BIOS Utility

There are five menu options: Information, Main, Security, Boot, and Exit.

Follow these instructions:

- To choose a menu, use the left and right arrow keys.
- To choose an item, use the up and down arrow keys.
- To change the value of a parameter, press **F5** or **F6**.
- Press **Esc** while you are in any of the menu options to go to the Exit menu.
- In any menu, you can load default settings by pressing **F9**. You can also press **F10** to save any changes made and exit the BIOS Setup Utility.

NOTE: You can change the value of a parameter if it is enclosed in square brackets. Navigation keys for a particular menu are shown on the bottom of the screen. Help for parameters are found in the Item Specific Help part of the screen. Read this carefully when making changes to parameter values. **Please note that system information is subject to different models.**

Information

The Information screen displays a summary of your computer hardware information.

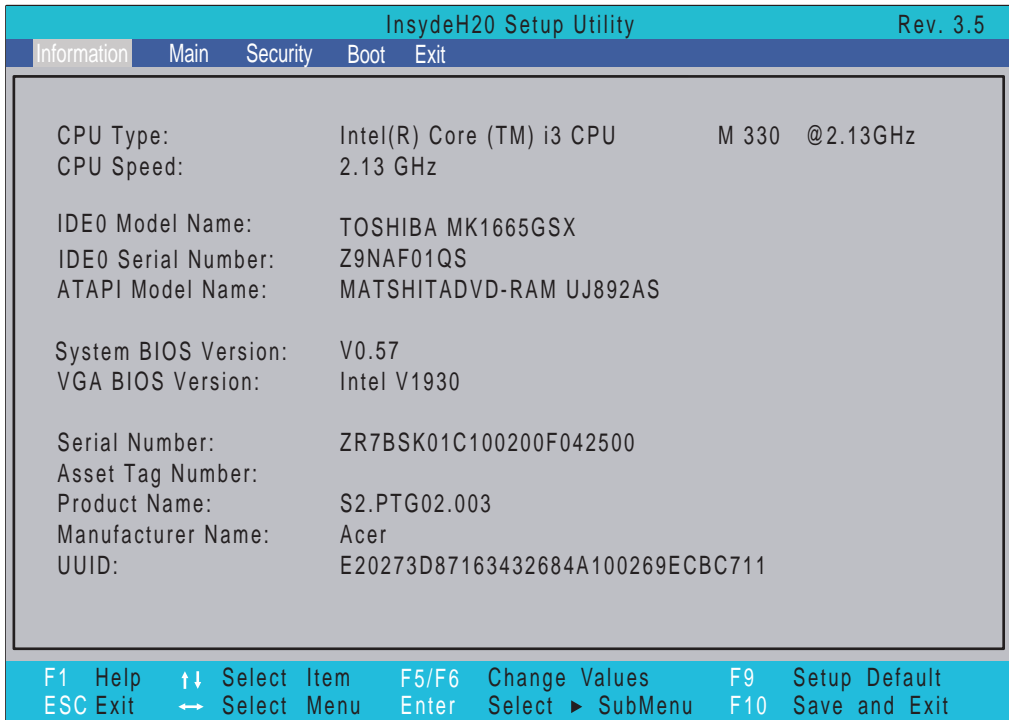

NOTE: The system information is subject to different models.

Parameter	Description
CPU Type	This field shows the CPU type and speed of the system.
CPU Speed	This field shows the speed of the CPU.
IDE0 Model Name	This field shows the model name of HDD installed in the system
IDE0 Serial Number	This field displays the serial number of HDD installed in the system
ATAPI Model Name	This field displays the model name of the installed ODD drive.
System BIOS Version	Displays system BIOS version.
VGA BIOS Version	This field displays the VGA firmware version of the system.
Serial Number	This field displays the serial number of this unit.
Asset Tag Number	This field displays the asset tag number of the system.
Product Name	This field shows product name of the system.
Manufacturer Name	This field displays the manufacturer of this system.
UUID Number	Universally Unique Identifier (UUID) is an identifier standard used in software construction, standardized by the Open Software Foundation (OSF) as part of the Distributed Computing Environment (DCE).

Main

The Main screen allows the user to set the system time and date as well as enable and disable boot option and recovery.

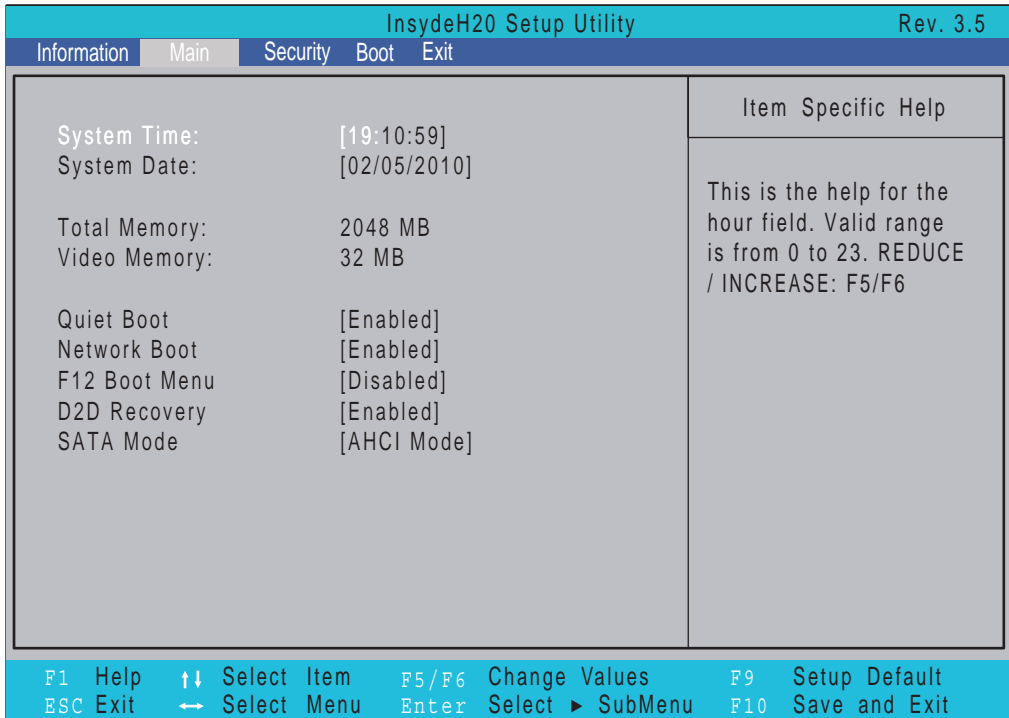

NOTE: The screen above is for your reference only. Actual values may differ.

The table below describes the parameters in this screen. Settings in **boldface** are the default and suggested parameter settings.

Parameter	Description	Format/Option
System Time	Sets the system time. The hours are displayed with 24-hour format.	Format: HH:MM:SS (hour:minute:second)
System Date	Sets the system date.	Format MM/DD/YYYY (month/day/year)
Total Memory	This field reports the memory size of the system.	N/A
Video Memory	Shows the video memory size. VGA Memory size=32 MB	N/A
Quiet Boot	This will hide POST messages while booting.	Option: Enabled or Disabled
Network Boot	Enables, disables the system boot from LAN (remote server).	Option: Enabled or Disabled
F12 Boot Menu	Enables, disables Boot Menu during POST.	Option: Disabled or Enabled
D2D Recovery	Enables, disables D2D Recovery function. The function allows the user to create a hidden partition on hard disc drive to store the operation system and restore the system to factory defaults.	Option: Enabled or Disabled
SATA Mode	Control the mode in which the SATA controller should operate.	Option: AHCI mode or IDE mode

Security

The Security screen contains parameters that help safeguard and protect your computer from unauthorized use.

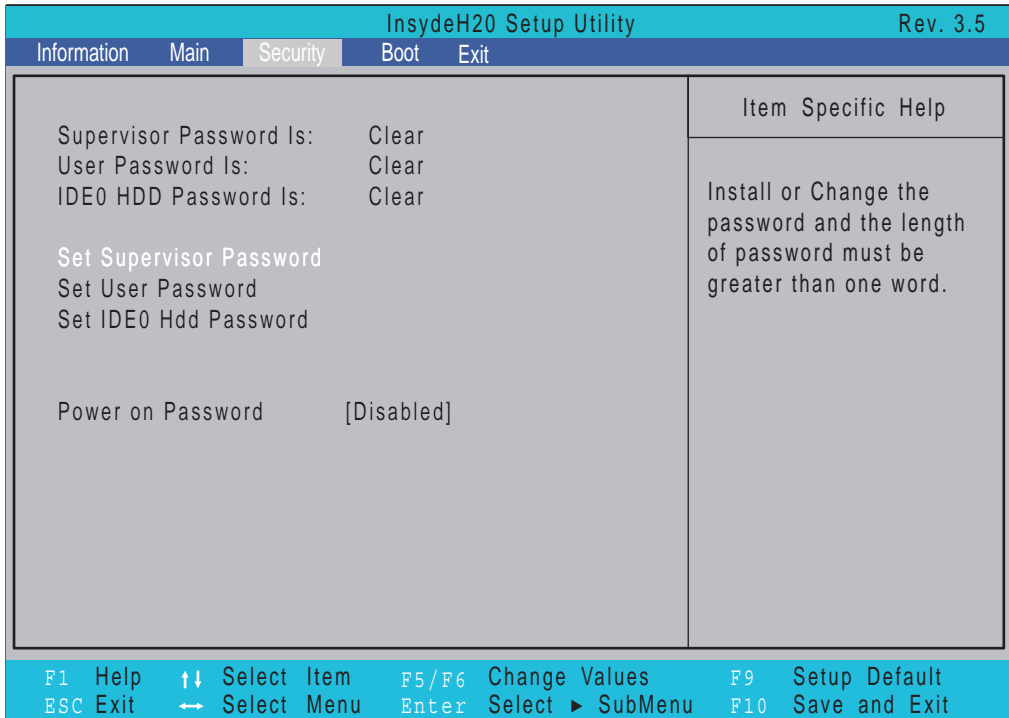

The table below describes the parameters in this screen. Settings in **boldface** are the default and suggested parameter settings.

Parameter	Description	Option
Supervisor Password Is	Shows the setting of the Supervisor password	Clear or Set
User Password Is	Shows the setting of the user password.	Clear or Set
IDE0 HDD Password Is	Shows the setting of the HDD password	Clear or Set
Set Supervisor Password	Press Enter to set the supervisor password. When set, this password protects the BIOS Setup Utility from unauthorized access. The user can not either enter the Setup menu nor change the value of parameters.	
Set User Password	Press Enter to set the user password. When user password is set, this password protects the BIOS Setup Utility from unauthorized access. The user can enter Setup menu only and does not have right to change the value of parameters.	
Set IDE0 Hdd Password	Press Enter to set the HDD password. When set this protects the HDD from unauthorized access.	
Power on password	Defines whether a password is required or not while the events defined in this group happened. The sub-options all require the Supervisor password for changes and should be grayed out if the user password was used to enter setup.	Disabled or Enabled

NOTE: When you are prompted to enter a password, you have three tries before the system halts. Don't forget the password. If you forget the password, you may have to reset the computer.

Setting a Password

Follow these steps as you set the user or the supervisor password:

1. Use the ↑ and ↓ keys to highlight the Set Supervisor Password parameter and press the **Enter** key. The Set Supervisor Password box appears:

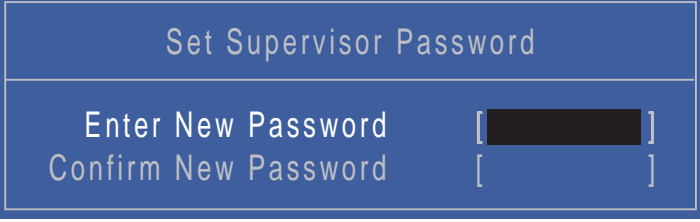

Set Supervisor Password	
Enter New Password	[██████████]
Confirm New Password	[]

2. Type a password in the “Enter New Password” field. The password length can not exceeds 8 alphanumeric characters (A-Z, a-z, 0-9, not case sensitive). Retype the password in the “Confirm New Password” field.

IMPORTANT: Be very careful when typing your password because the characters do not appear on the screen.

3. Press **Enter**. After setting the password, the computer sets the User Password parameter to “Set”.
4. If desired, you can opt to enable the Password on boot parameter.
5. When you are done, press F10 to save the changes and exit the BIOS Setup Utility.

Removing a Password

Follow these steps:

1. Use the ↑ and ↓ keys to highlight the Set Supervisor Password parameter and press the **Enter** key. The Set Supervisor Password box appears:



Set Supervisor Password	
Enter Current Password	[██████████]
Enter New Password	[]
Confirm New Password	[]

2. Type the current password in the Enter Current Password field and press **Enter**.
3. Press **Enter** twice **without** typing anything in the Enter New Password and Confirm New Password fields. The computer then sets the Supervisor Password parameter to “Clear”.

Changing a Password

1. Use the ↑ and ↓ keys to highlight the Set Supervisor Password parameter and press the **Enter** key. The Set Password box appears.



The screenshot shows a blue BIOS screen titled "Set Supervisor Password". It contains three input fields: "Enter Current Password", "Enter New Password", and "Confirm New Password". The "Enter Current Password" field is filled with blacked-out characters, while the other two fields are empty.

2. Type the current password in the Enter Current Password field and press **Enter**.
3. Type a password in the Enter New Password field. Retype the password in the Confirm New Password field.
4. Press **Enter**. After setting the password, the computer sets the User Password parameter to "Set".
5. If desired, you can enable the Password on boot parameter.
6. When you are done, press **F10** to save the changes and exit the BIOS Setup Utility.

If the verification is OK, the screen will display as following.

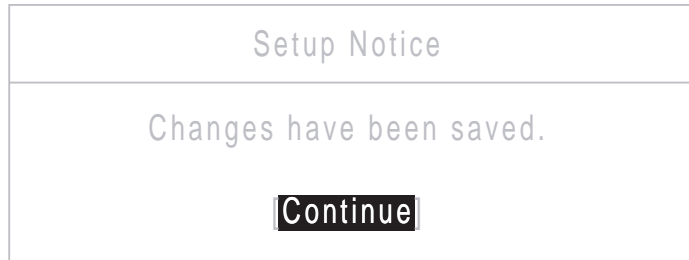

The screenshot shows a white BIOS screen titled "Setup Notice". The text "Changes have been saved." is displayed in the center. At the bottom, there is a black button with the word "Continue" in white text.

The password setting is complete after the user presses **Enter**.

If the current password entered does not match the actual current password, the screen will show you the Setup Warning.



The screenshot shows a white BIOS screen with a red border titled "Setup Warning". The text "Invalid Password." is displayed in red. At the bottom, there is a black button with the word "Continue" in white text.

If the new password and confirm new password strings do not match, the screen displays the following message.



The screenshot shows a white BIOS screen with a red border titled "Setup Warning". The text "Passwords do not match. Re-enter password." is displayed in red. At the bottom, there is a black button with the word "Continue" in white text.

Boot

This menu allows the user to decide the order of boot devices to load the operating system. Bootable devices includes the USB diskette drives, the onboard hard disk drive and the DVD drive in the module bay.

InsydeH20 Setup Utility				Rev. 3.5
Information	Main	Security	Boot	Exit
Boot priority order:			Item Specific Help	
1. IDE0 : TOSHIBA MK1665GSX 2. IDE1 : MATSHITADVD-RAM UJ892AS 3. USB FDD : 4. Network Boot : Atheros Boot Agent 5. USB HDD : 6. USB CDROM :			Use <↑> or <↓> to select a device, then press <F5> to move it down the list, or <F6> to move it up the list. Press <Esc> to escape the menu	
F1 Help	↑↓ Select Item	F5/F6 Change Values	F9 Setup Default	
ESC Exit	← Select Menu	Enter Select ► SubMenu	F10 Save and Exit	

Exit

The Exit screen allows you to save or discard any changes you made and quit the BIOS Utility.

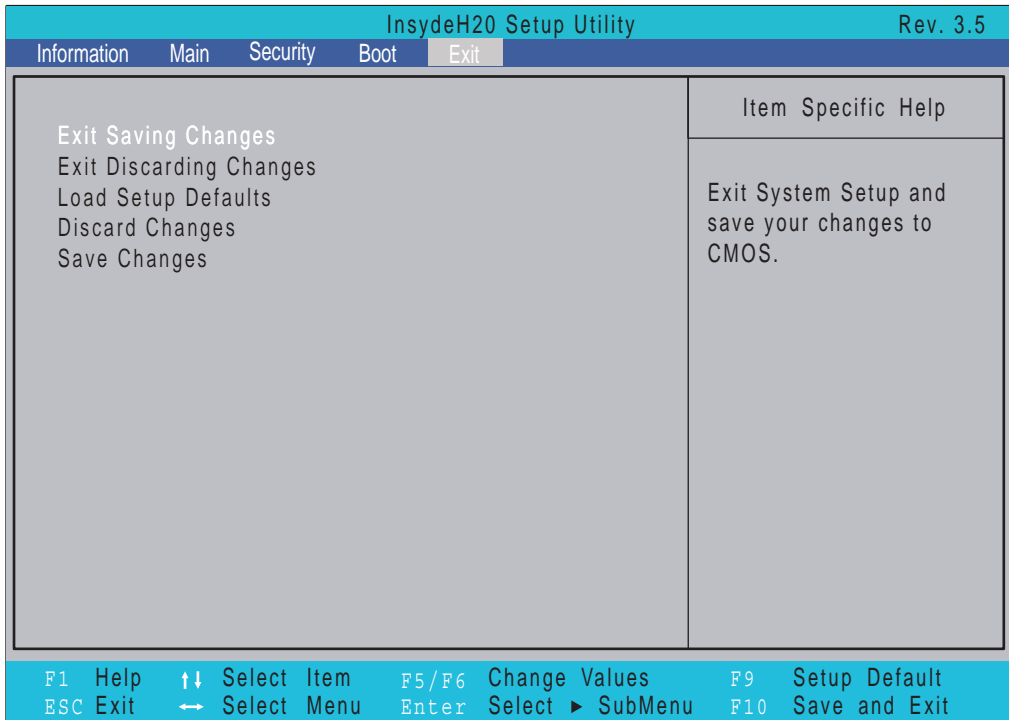

The table below describes the parameters in this screen.

Parameter	Description
Exit Saving Changes	Exit System Setup and save your changes to CMOS.
Exit Discarding Changes	Exit utility without saving setup data to CMOS.
Load Setup Default	Load default values for all SETUP item.
Discard Changes	Load previous values from CMOS for all SETUP items.
Save Changes	Save Setup Data to CMOS.

BIOS Flash Utility

The BIOS flash memory update is required for the following conditions:

- New versions of system programs
- New features or options
- Restore a BIOS when it becomes corrupted.

DOS Flash Utility

Perform the following steps to use the DOS Flash Utility:

1. Press F2 during boot to enter the Setup Menu.
2. Select **Boot Menu** to modify the boot priority order, for example, if using USB HDD to Update BIOS, move USB HDD to position 1.

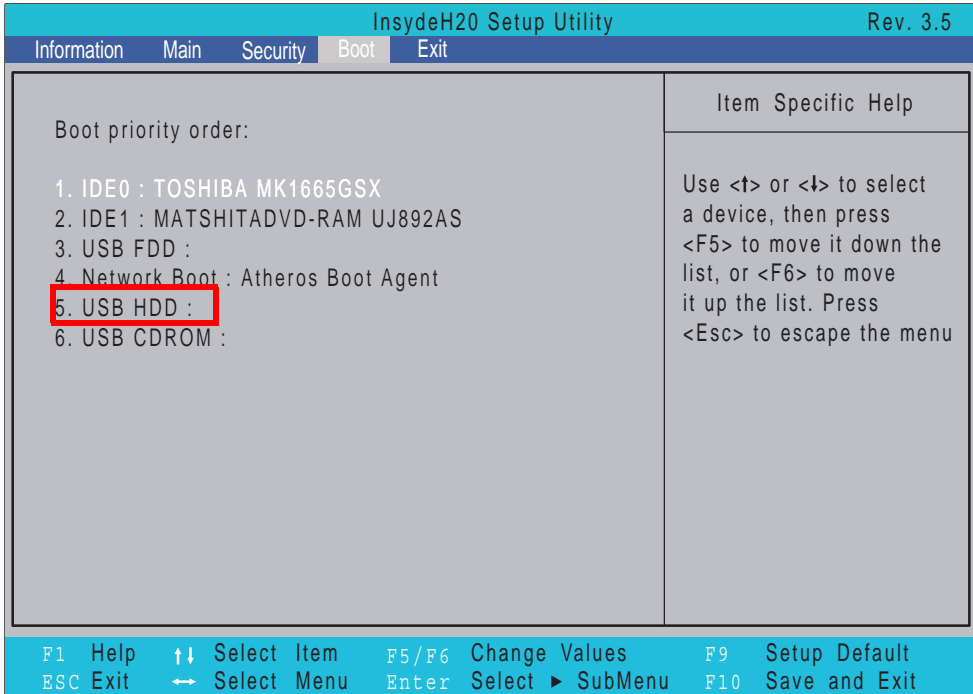

3. Execute the **FLASH.BAT** batch file to update BIOS. Or enter C:\ **Flash it bios ver.fd/dc**

The flash process begins as shown.

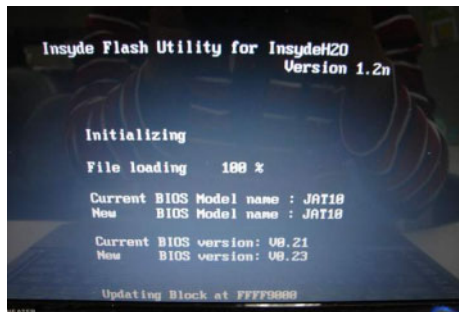

4. In flash BIOS, the message **Please do not remove AC Power Source** displays.

NOTE: If the AC power is not connected, the following message displays.



Plug in the AC power to continue.

5. Flash is complete when the message Flash programming complete displays.

WinFlash Utility

Perform the following steps to use the WinFlash Utility:

1. Double click the WinFlash executable.
2. Click **OK** to begin the update. A progress screen displays.

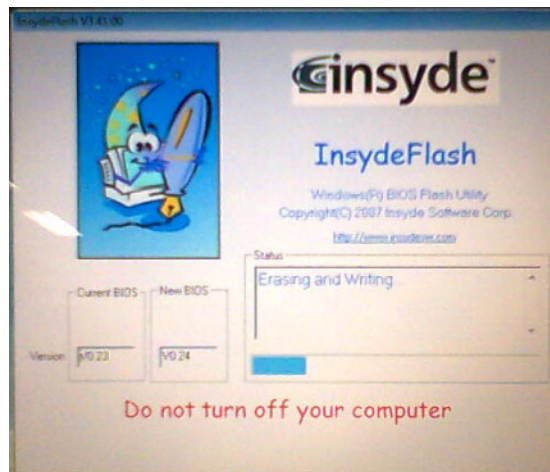

3. When the process is complete, close all programs and applications and reboot the system.

Remove HDD/BIOS Password Utilities

This section provide you with removing HDD/BIOS method:

Remove HDD Password:

When the user keys in the wrong password three times, the system reports the following error code to user.

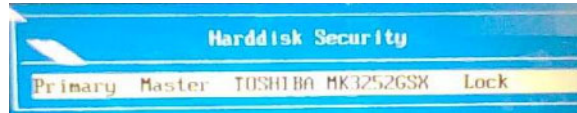

To unlock the HDD password, perform the following steps:

1. Press **Enter** to display the Select Item screen.

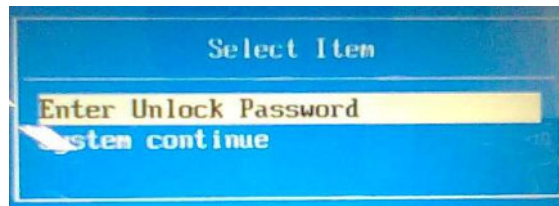

2. Select **Enter Unlock Password** and press **Enter**.

An Unlock Password displays.



3. Make a note of the key, **76943488** in the example.
4. Boot up the system to a removable bootable drive containing DOS and the UnlockHD.EXE program and open a DOS prompt. For instructions on changing boot priority see "Boot" on page 29.
5. From the DOS prompt, enter the **UnlockHD.EXE** command and input the key to create an unlock code. Make a note of the result, for example **46548274**.
6. Reboot to the hard disk and wait for the error code to reappear.
7. Press **Enter** to display the Select Item screen.
8. Select **Enter Unlock Password** and press **Enter**.
9. Enter the unlock code generated by UnlockHD.EXE.
10. Save and exit the BIOS to complete the process.

Removing BIOS Passwords:

If you key in the wrong Supervisor Password three times, System Disabled displays on the screen. See the image below.

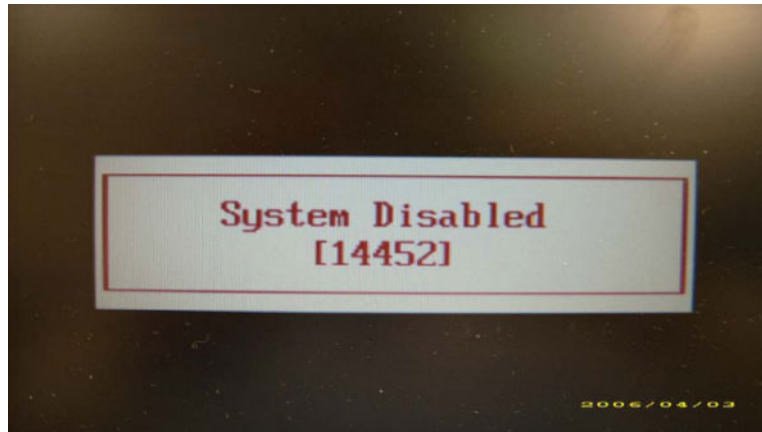

To reset the BIOS password, run clnpwd.exe as follows:

1. From a DOS prompt, Execute **clnpwd.exe**

```
d:\Clnpwd>clnpwd
ACER Clean Password Utility V1.00
Press 1 or 2 to clean any password shown as below
    1.User Password
    2.Supervisor Password

Clean User Password Successfully!
```

2. Press 1 or 2 to clean the desired password shown on the screen.

The onscreen message determines whether the function is successful or not.

Miscellaneous Utilities

Using Boot Sequence Selector

Boot Sequence Selector allows the boot order to be changes without accessing the BIOS. To use Boot Sequence Selector, perform the following steps:

1. Enter into DOS.
2. Execute BS.exe to display the usage screen.

```
d:\BOOTSEQ>bs
*** Boot Sequence Selector Version 0.03 ***
Create by Rockwell Chuang 10/01/2005.
Usage:
      BS [ 1 | 2 | 3 | 4 ]
BS 1 : [ Floppy ] => [ HardDisk ] => [ CD-ROM ] => [ LAN   ]
BS 2 : [ HardDisk ] => [ CD-ROM ] => [ LAN   ] => [ Floppy ]
BS 3 : [ CD-ROM ] => [ HardDisk ] => [ LAN   ] => [ Floppy ]
BS 4 : [ LAN   ] => [ Floppy ] => [ HardDisk ] => [ CD-ROM ]
d:\BOOTSEQ>
```

3. Select the desired boot sequence by entering the corresponding sequence, for example, enter BS2 to change the boot sequence to HDD|CD ROM|LAN|Floppy.

Using DMI Tools

The DMI (Desktop Management Interface) Tool copies BIOS information to eeprom to be used in the DMI pool for hardware management.

When the BIOS displays **Verifying DMI pool data** it is checking the table correlates with the hardware before sending to the operating system (Windows, etc.).

To update the DMI Pool, perform the following steps:

1. Enter into DOS.
2. Execute **qdmtools.exe**. The following messages show dmitools usage:

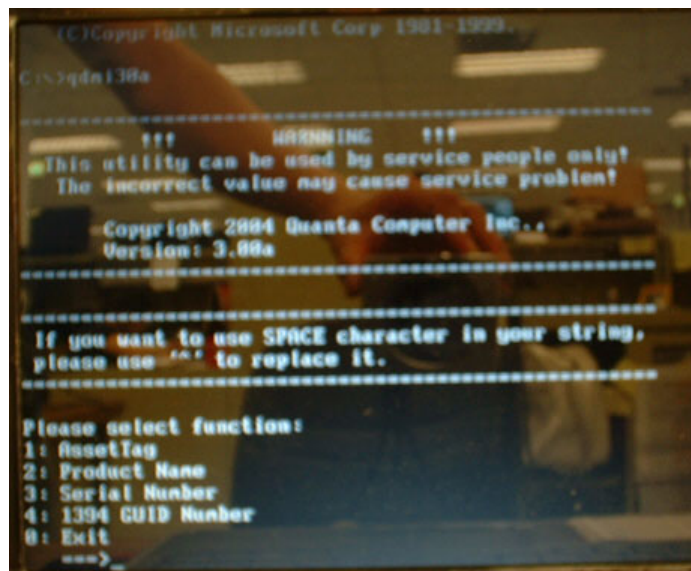

3. Enter the required key number of the feature required to be modified. See the following table.

Key No.	Function Description
1	Enter 1 to modify the Asset Tag
2	Enter 2 to modify the Product Name
3	Enter 3 to modify the Serial Number
4	Enter 4 to modify the 1394 GUID Number
0	Enter 0 to exit the program

Using the LAN MAC Utility

Perform the following steps to write MAC information to eeprom:

1. Use a text editor, for example Notepad, to edit the MAC.CFG file as shown:

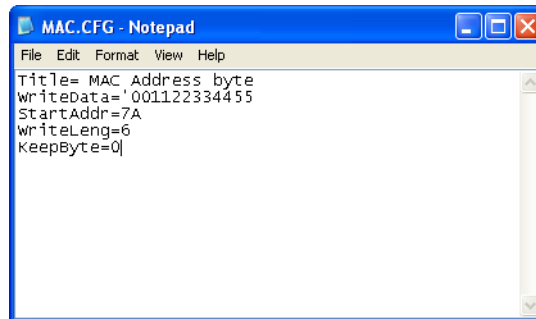

```
MAC.CFG - Notepad
File Edit Format View Help
Title= MAC Address byte
WriteData='001122334455'
StartAddr=7A
WriteLeng=6
KeepByte=0
```

- WriteData= '001122334455' <----- MAC value
 - StartAddr=7A <----- MAC address
 - WriteLeng=6 <----- MAC value length
 - KeepByte=0 <----- can be any value
2. Boot into DOS.
3. Execute **MAC.BAT** to write MAC information to eeprom.

Machine Disassembly and Replacement

This chapter contains step-by-step procedures on how to disassemble the notebook computer for maintenance and troubleshooting.

Disassembly Requirements

To disassemble the computer, you need the following tools:

- Wrist grounding strap and conductive mat for preventing electrostatic discharge
- Flat screwdriver
- Philips screwdriver
- Plastic flat screwdriver
- Plastic tweezers

NOTE: The screws for the different components vary in size. During the disassembly process, group the screws with the corresponding components to avoid mismatch when putting back the components.

Related Information

The product previews seen in the disassembly procedures may not represent the final product color or configuration.

IMPORTANT: Cable paths and positioning may not represent the actual model. During the removal and replacement of components, ensure all available cable channels and clips are used and that the cables are replaced in the same position.

Replacement Requirements

NOTE: Cabling and components require adhesive to be applied during the replacement and reassembly process.

NOTE: During manufacture a cyanoacrylate glue is used provided by Holdtite Adhesives LTD. This is not a specified requirement. The reassembler is free to select an alternative appropriate adhesive.

Pre-disassembly Instructions

Before proceeding with the disassembly procedure, make sure that you do the following:

1. Turn off the power to the system and all peripherals.
2. Unplug the AC adapter and all power and signal cables from the system.



3. Place the system on a flat, stable surface.

Disassembly Process

The disassembly process is divided into the following sections:

- External components disassembly
- Main unit disassembly
- LCD module disassembly

The flowcharts provided in the succeeding disassembly sections illustrate the entire disassembly sequence. Observe the order of the sequence to avoid damage to any of the hardware components. For example, if you want to remove the Mainboard, you must first remove the Keyboard, and LCD Module then disassemble the inside assembly frame in that order.

Main Screw List

Screw	Quantity	Acer Part Number
M2.5*5	32	86.ARE07.003
M2*3Ni	5	86.A08V7.005
M2.5*4	2	86.PTN07.004
M2.5*4Ni	7	86.EDM07.003
M2.5*3	9	86.PTN07.003
T2.5*2	5	86.B1907.005
M3*3Ni	2	86.N1407.007
M2*3	3	86.ARE07.002

External Module Disassembly Process

NOTE: The product previews seen in the disassembly procedures may not represent the final product color or configuration.

External Modules Disassembly Flowchart

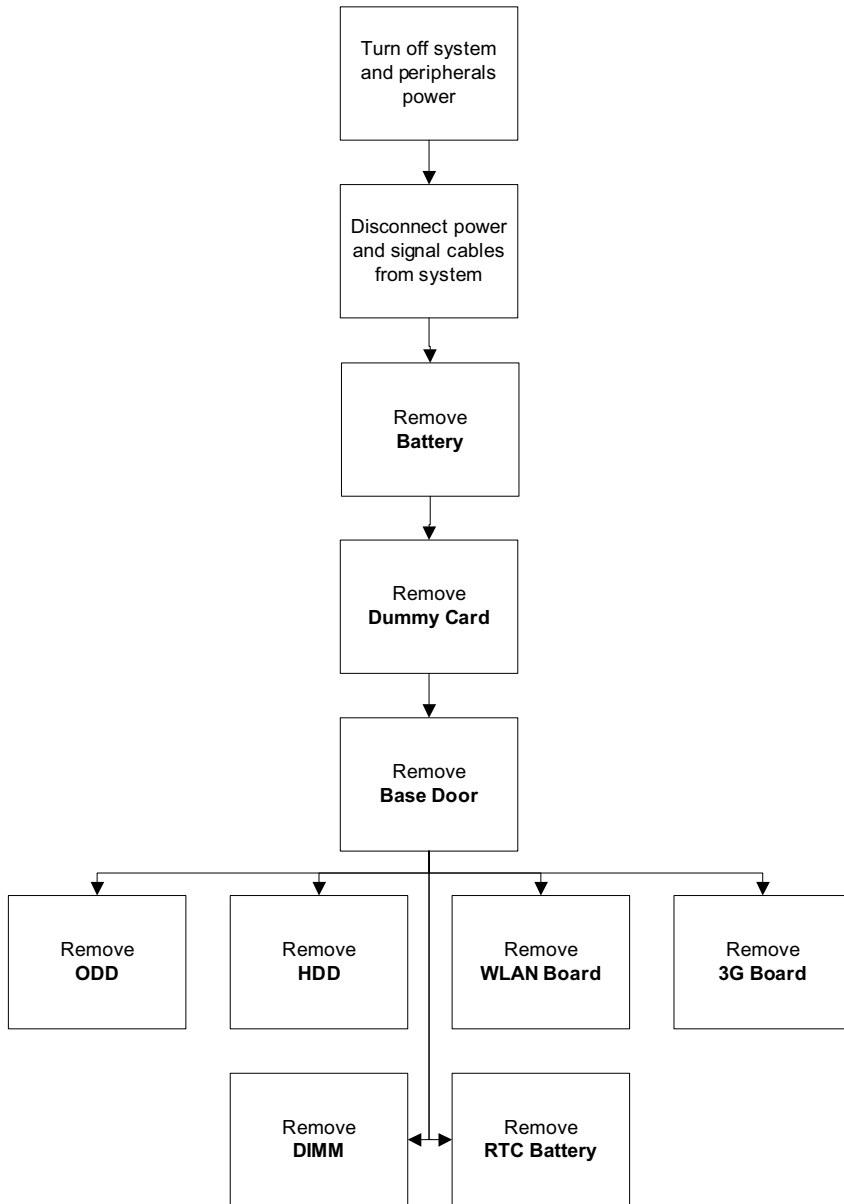

Screw List

Step	Screw	Quantity	Part No.
Base Cover Disassembly	M2.5*5	8	86.ARE07.003
WLAN Module Disassembly	M2.0*3Ni	1	86.A08V7.005
3G Module Disassembly	M2.0*3Ni	1	86.A08V7.005
HDD Disassembly	M3*3Ni	2	86.N1407.007
ODD Module Disassembly	M2*3	2	86.A08V7.005

Removing the Battery Pack

1. Turn the computer over.
2. Slide the battery lock/unlock latch to the unlock position.



3. Slide and hold the battery release latch to the release position (1), then slide out the battery pack from the main unit (2).

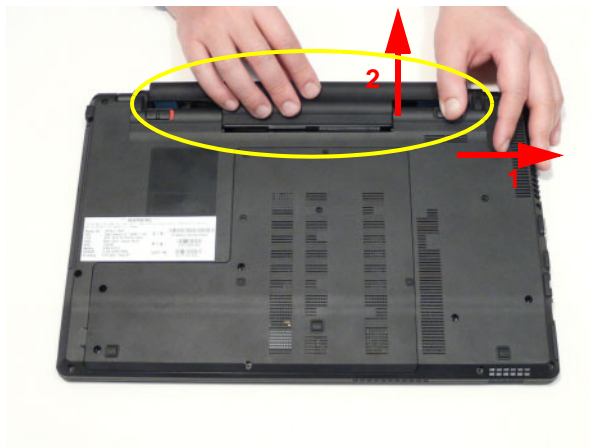

NOTE: The battery has been highlighted with a yellow oval as shown in the above image. Please detach the battery and follow local regulations for disposal.

Removing the Dummy Card

1. Press the dummy card in to allow it to spring out.



2. Pull the dummy card out.



Removing the SIM Card

1. See “Removing the Battery Pack” on page 43.
2. Push the SIM card in to allow it to spring out.





3. Pull the SIM card out.

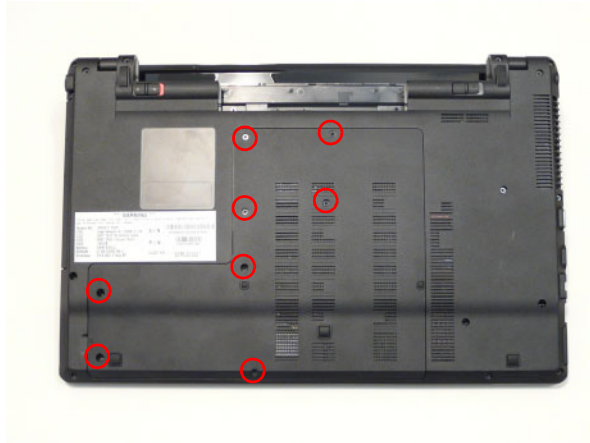

Removing the Base Door

1. See "Removing the Battery Pack" on page 43.
2. Remove the eight (8) screws.



Step	Screw	Quantity	Screw Type
Base Door Disassembly	M2.5*5	8	

3. Lift the base door up at the finger indentation location provided in the bottom cover.

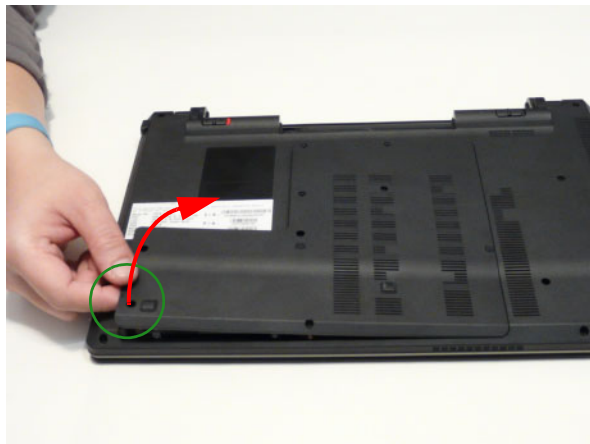

-
4. Lift the base door out and away.

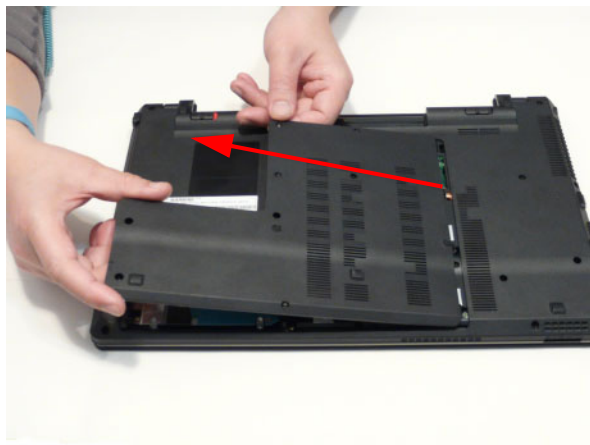

Removing the Hard Disk Drive Module

1. See “Removing the Battery Pack” on page 43.
2. See “Removing the Base Door” on page 46.
3. Grasp the pull tab on the top of the HDD.



4. Pull the tab horizontally to slide the HDD out of the connector dock.

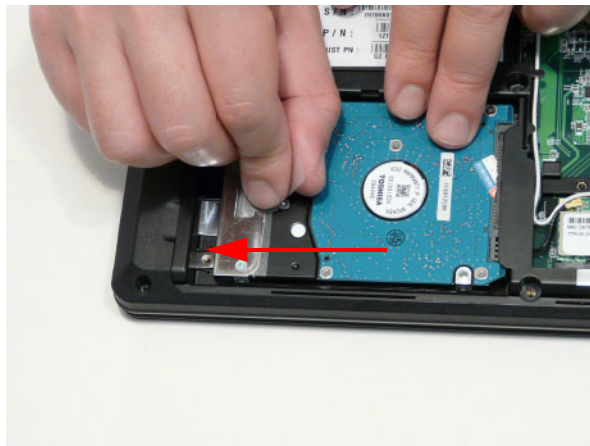

5. Lift the HDD out.

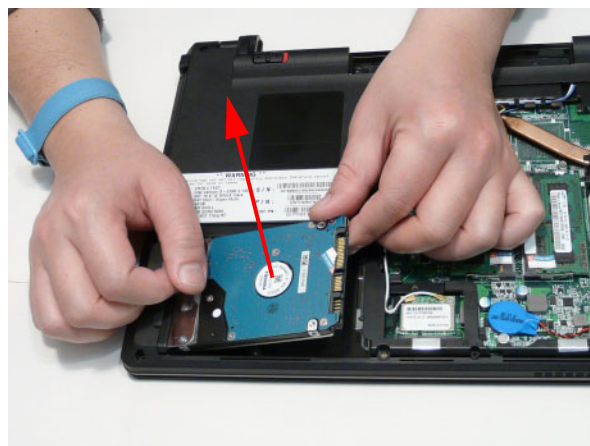

6. Remove the two (2) screws of the HDD bracket.

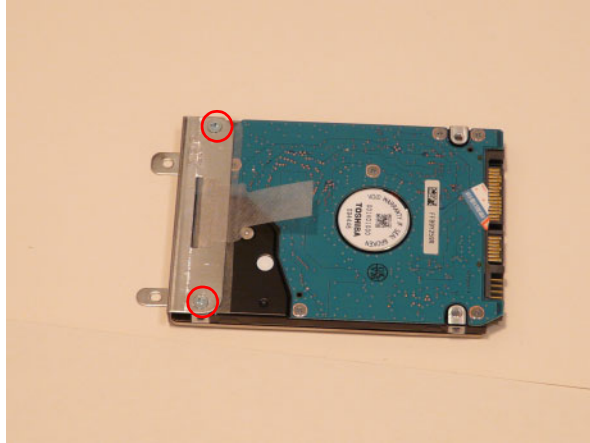

Step	Screw	Quantity	Screw Type
HDD Bracket Disassembly	M3*3Ni	2	

7. Lift the bracket away from the HDD.

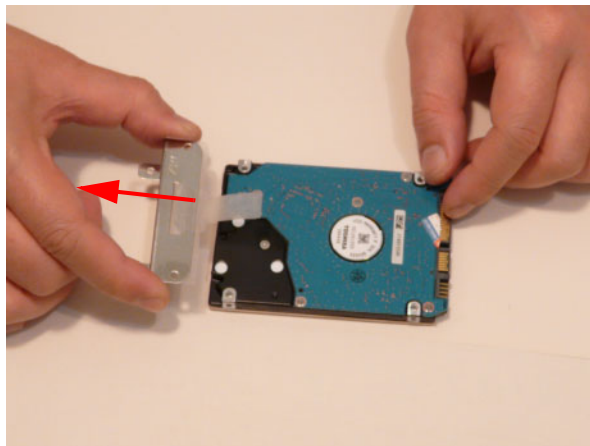

Removing the DIMM Module

1. See “Removing the Battery Pack” on page 43.
2. See “Removing the Base Door” on page 46.
3. Push the memory module clips outwards.

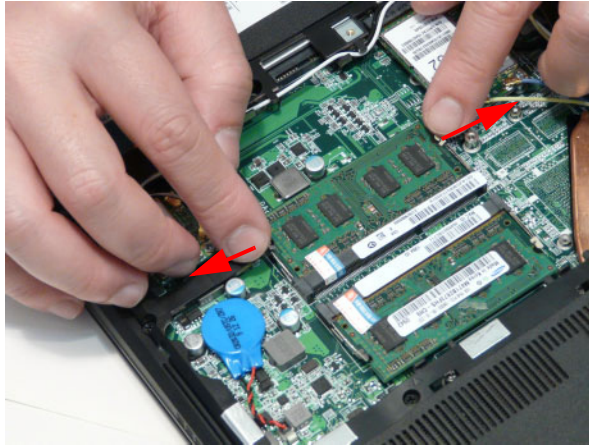

4. Pull the memory module out.



Removing the WLAN Module

1. See “Removing the Battery Pack” on page 43.
2. See “Removing the Base Door” on page 46.
3. Detach the two (2) cables from the Wireless LAN module.

IMPORTANT: Take note of the Main (black) and Auxiliary (white) connectors.



4. Remove the one (1) screw. Ensure the cables are well clear of the module.



Step	Screw	Quantity	Screw Type
WLAN Module Disassembly	M2.0*3Ni	1	

-
5. Pull the WLAN module out and away.

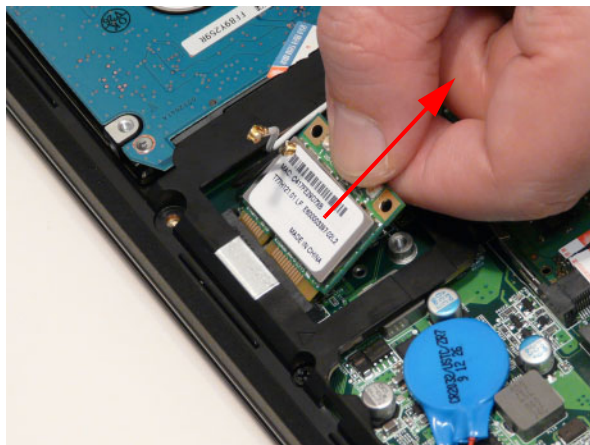

Removing the 3G Module

1. See "Removing the Battery Pack" on page 43.
2. See "Removing the Base Door" on page 46.
3. Detach the two (2) cables from the 3G module.

IMPORTANT: Take note of the Main (yellow) and Auxiliary (blue) connectors.



4. Remove the one (1) screw.



Step	Screw	Quantity	Screw Type
3G Module Disassembly	M2.0*3Ni	1	

-
5. Pull the 3G module out and away.

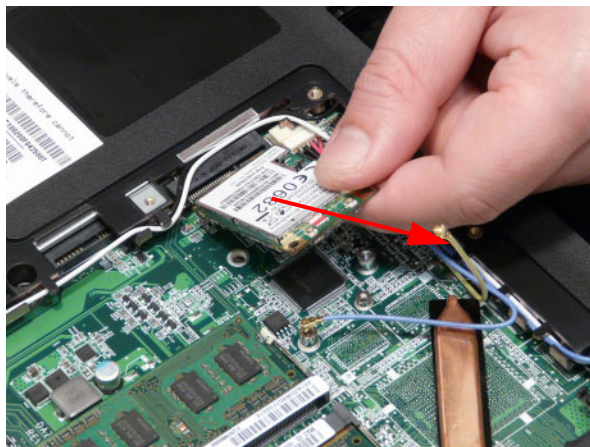

Removing the ODD Module

1. See “Removing the Battery Pack” on page 43.
2. See “Removing the Base Door” on page 46.
3. Push the ODD module out of the bay at the location shown.



4. Pull the ODD completely out of the bay.



5. Remove the two (2) screws of the ODD bracket.



Step	Screw	Quantity	Screw Type
ODD Module Disassembly	M2*3Ni	2	

6. Remove the ODD bracket.

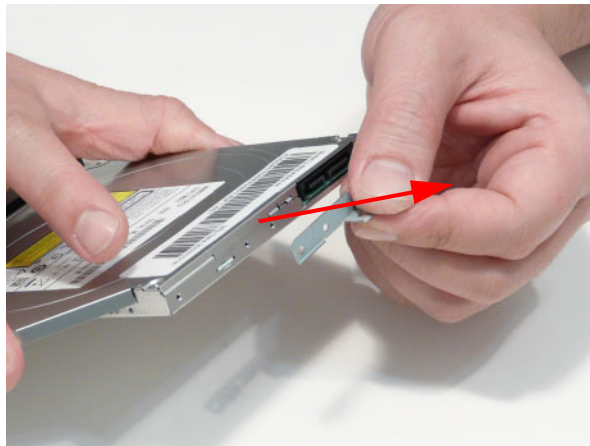

7. Pry the ODD bezel off the ODD module.



Removing the RTC Battery

1. See “Removing the Battery Pack” on page 43.
2. See “Removing the Base Door” on page 46.
3. Disconnect the RTC connector.

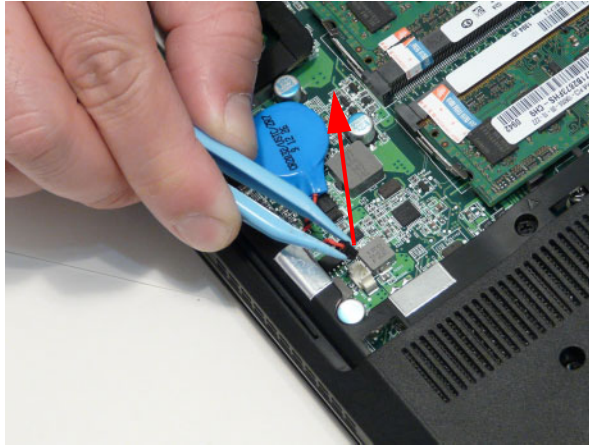

4. Pull the RTC battery off the mainboard.

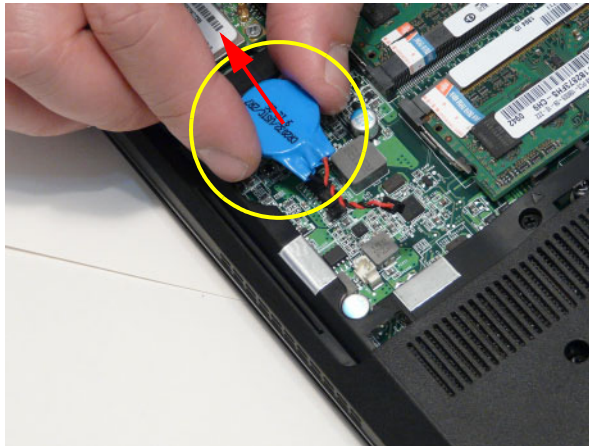

NOTE: The RTC battery has been highlighted with the yellow circle as shown in the previous image. Please detach the RTC battery and follow local regulations for disposal.

Main Unit Disassembly Process

IMPORTANT: Cable paths and positioning may not represent the actual model. During the removal and replacement of components, ensure all available cable channels and clips are used and that the cables are replaced in the same position.

NOTE: The product previews seen in the disassembly procedures may not represent the final product color or configuration.

Main Unit Disassembly Flowchart

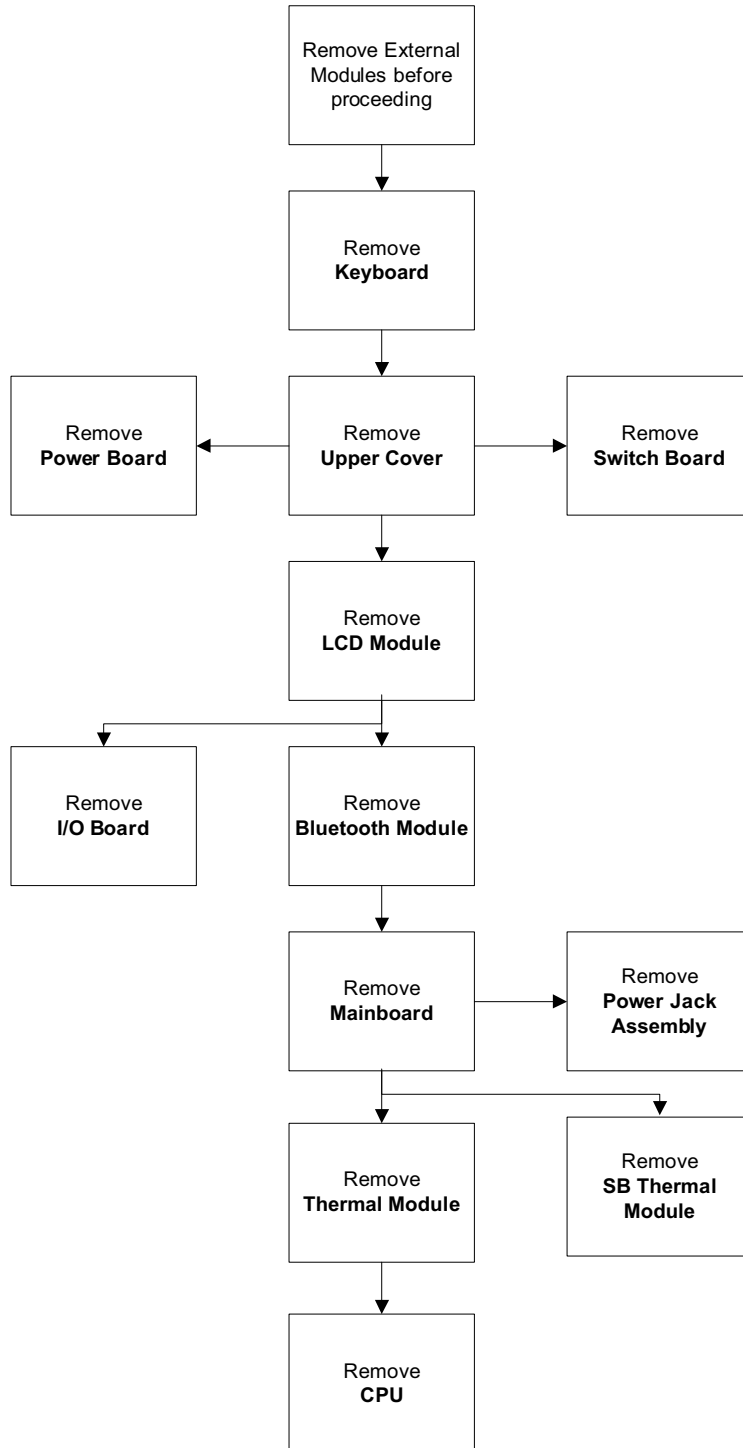

Screw List

Step	Screw	Quantity	Part No.
Upper Cover Disassembly	M2.5*4Ni	6	86.EDM07.003
	M2.0*3	3	86.A08V7.005

Step	Screw	Quantity	Part No.
Lower Cover Disassembly	M2.5*5	19	86.ARE07.003
	T2.5*2Ni	1	86.B1907.005
Switch Board Disassembly	T2.5*2Ni	2	86.B1907.005
Power Module Disassembly	T2.5*2Ni	2	86.B1907.005
I/O Board Disassembly	M2.5*5	1	86.ARE07.003
Bluetooth Module Disassembly	M2.0*3	1	86.A08V7.005
Mainboard Disassembly	M2.5*5	2	86.ARE07.003
Power Jack Assembly Disassembly	M2.5*4	1	86.EDM07.003

Removing the Keyboard

IMPORTANT: The keyboard is easily warped or damaged during the removal process. Take care not to use excessive force when removing to prevent damage.

1. See “Removing the Battery Pack” on page 43.
2. See “Removing the SIM Card” on page 45.
3. See “Removing the DIMM Module” on page 50.
4. See “Removing the WLAN Module” on page 51.
5. See “Removing the 3G Module” on page 53.
6. See “Removing the ODD Module” on page 55.
7. Using the plastic pry, press in the five (5) latches along the top of the keyboard to release the keyboard from the cover.

NOTE: The keyboard will spring up slightly when all retaining clips are unlocked.



8. Lift up the top right edge of the keyboard and then lift the keyboard up.

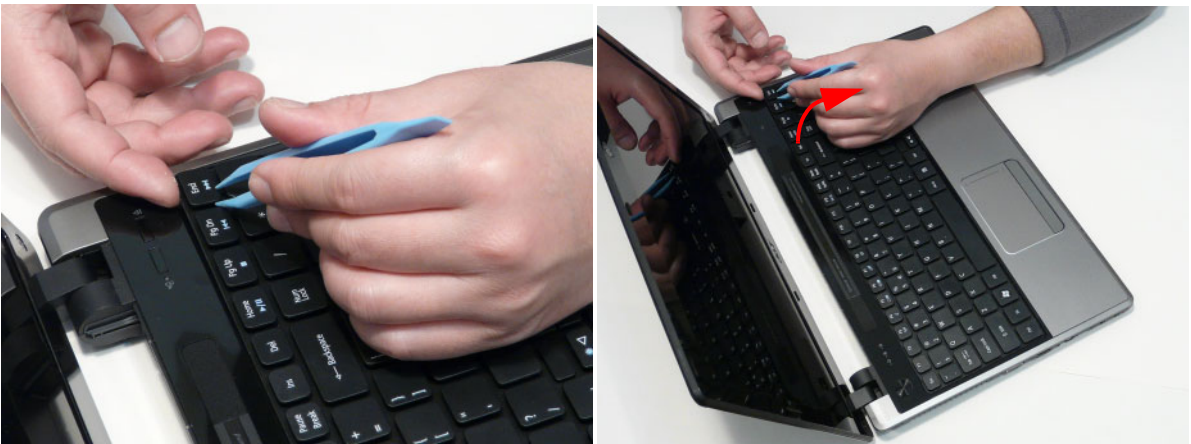

9. Flip the keyboard over.



10. Detach the keyboard FPC.

a. Unlock the FPC

b. Pull the keyboard away

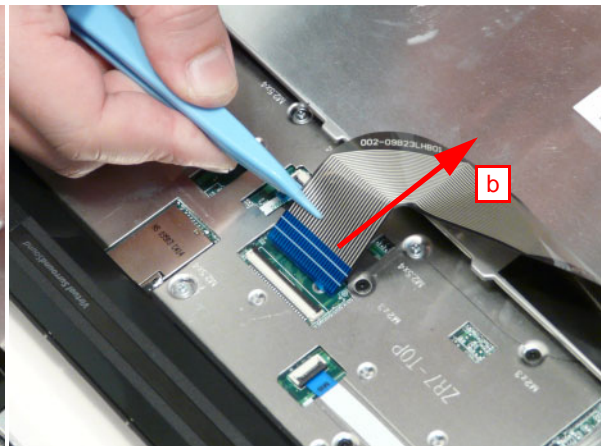
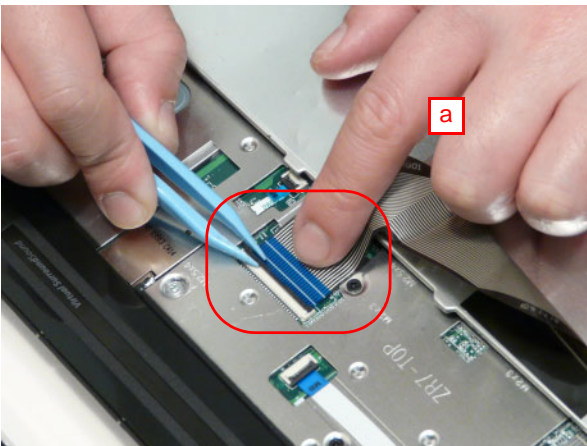

Removing the Upper Cover

1. See "Removing the Keyboard" on page 61.
2. Unlock and disconnect the Touchpad board FFC.

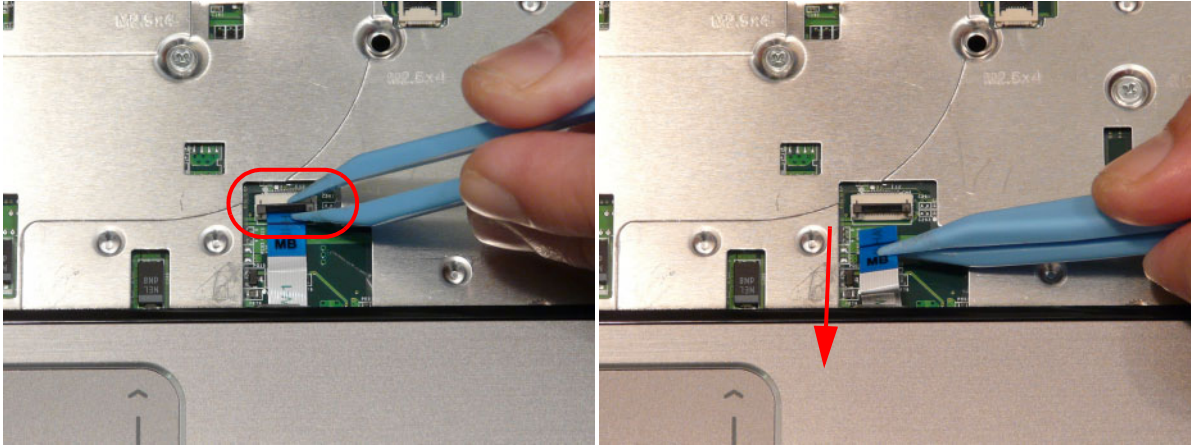

3. Unlock and disconnect the switch board FFC.

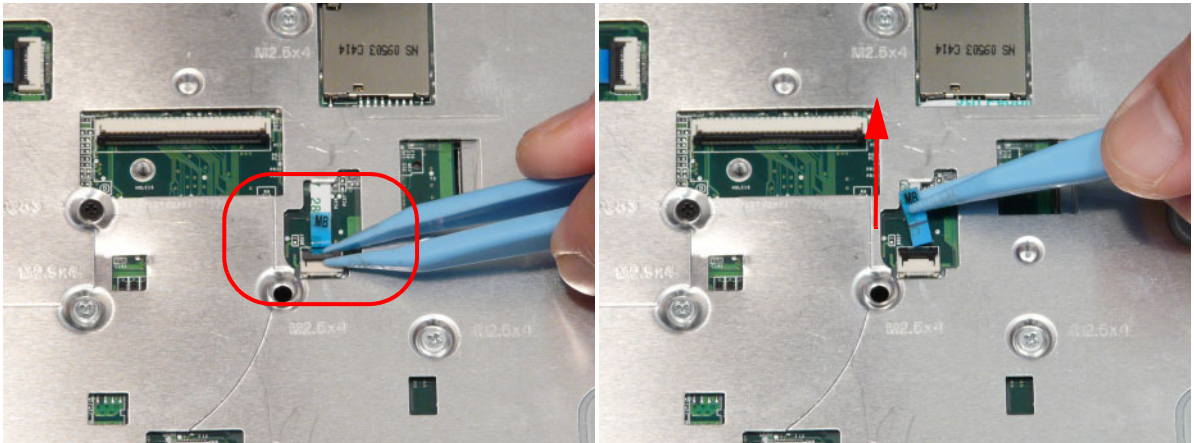

4. Unlock and disconnect the power board FFC.

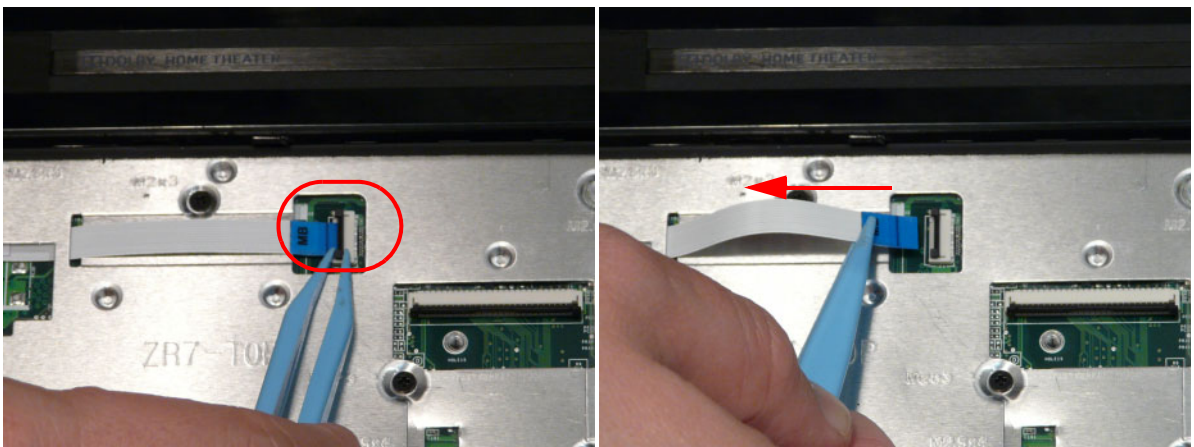

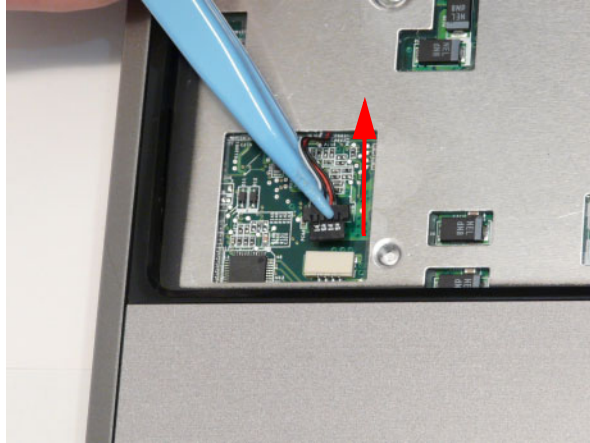

5. Disconnect the speaker cable.



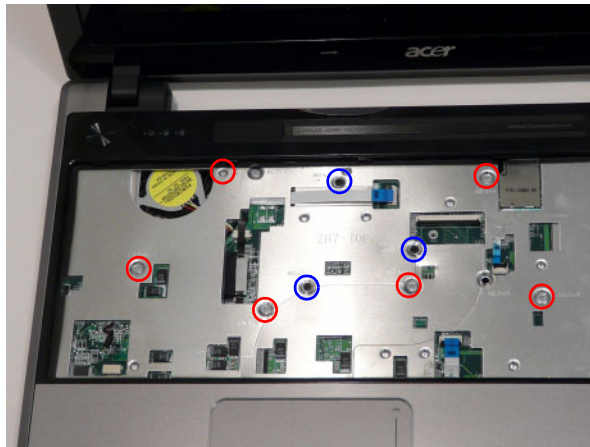

6. Remove the nine (9) screws in the upper cover.

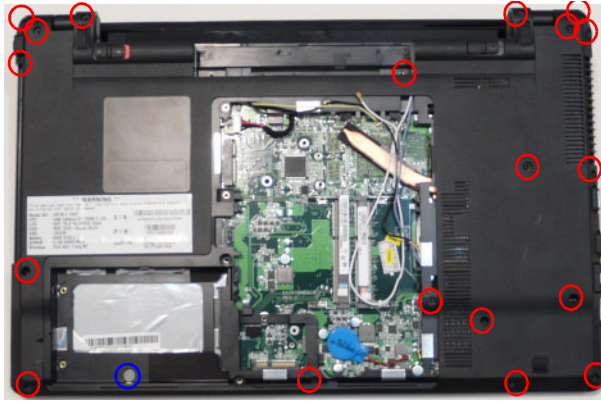

Step	Screw	Quantity	Screw Type
Upper Cover Disassembly	M2.5*4Ni (red call out)	6	
	M2*3 (blue call out)	3	

7. Turn the computer over and remove the twenty (20) screws in the lower cover.



Step	Screw	Quantity	Screw Type
Lower Cover Disassembly	M2.5*5 (red call out)	19	
	T2.5*2 Ni (blue call out)	1	

8. Turn the computer ninety degrees. Push the upper cover apart from the lower cover in the location shown.

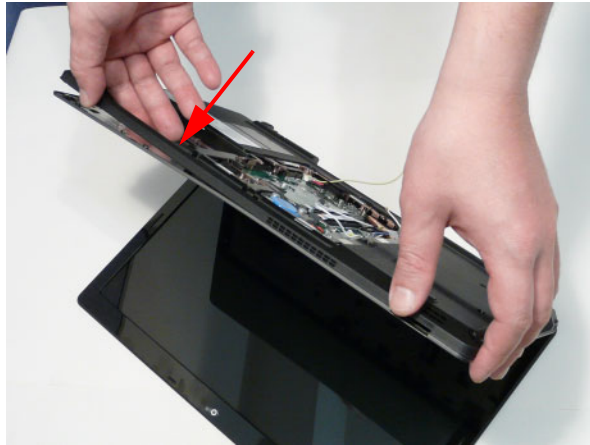

9. Pry the upper cover away from the lower cover along the front edge.



10. Push the upper cover off the bottom cover.



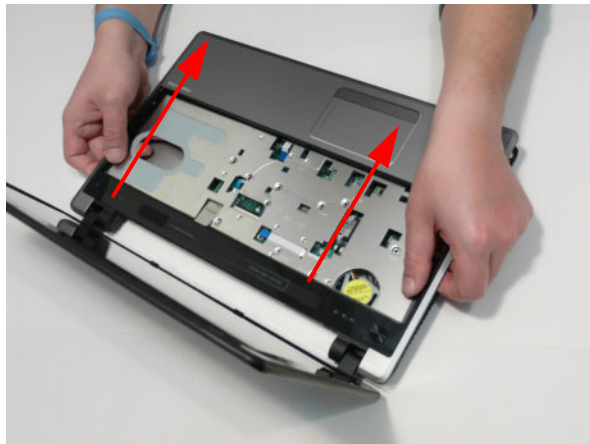

11. Lay the computer flat then pull the upper cover away from the lower cover.

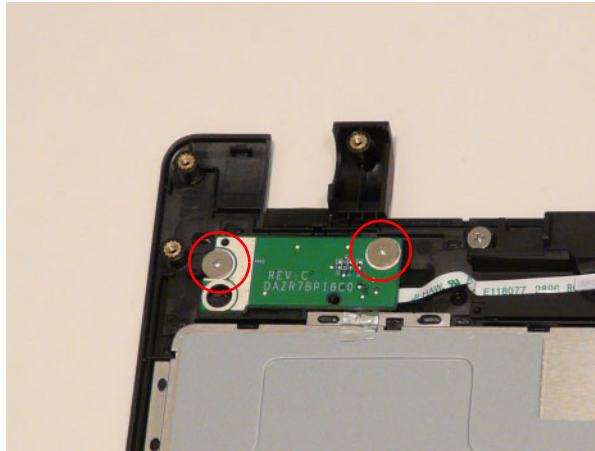

Removing the Switch Board

1. See "Removing the Upper Cover" on page 63.
2. Remove the two (2) screws.



Step	Screw	Quantity	Screw Type
Switch Board Disassembly	T2.5*2Ni	2	

3. Lift the switch board away from the upper cover and turn it over.

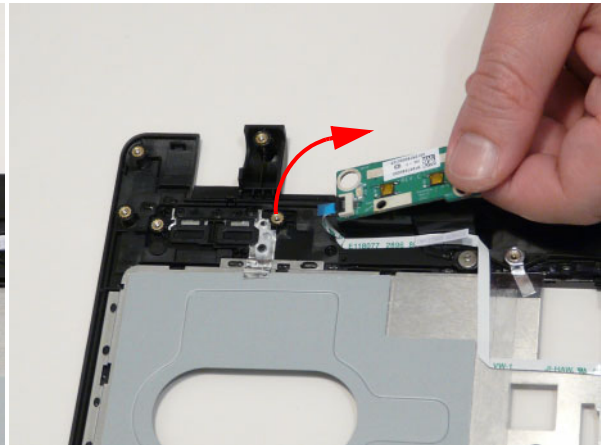
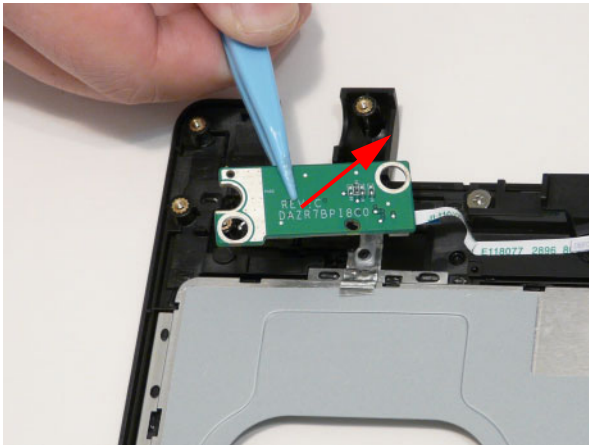

4. Unlock and disconnect the switch board FFC.

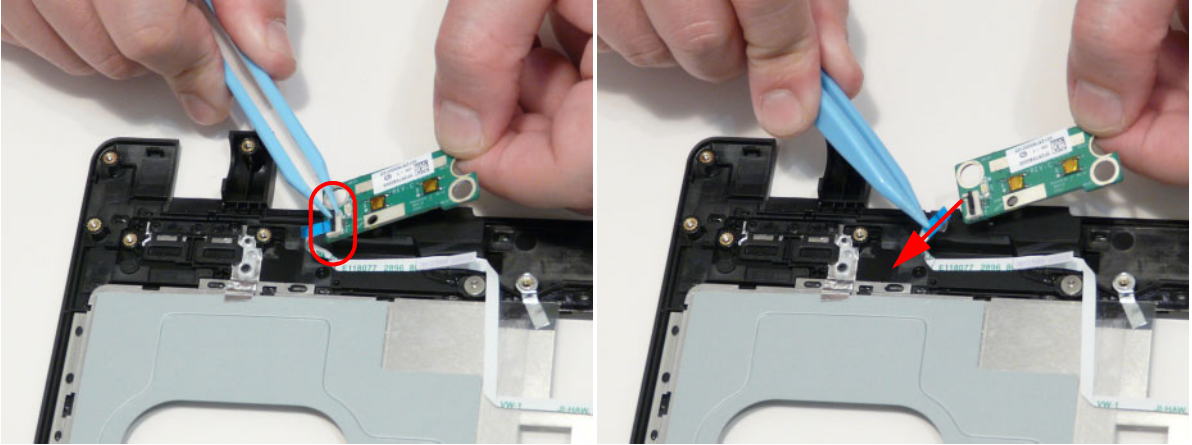

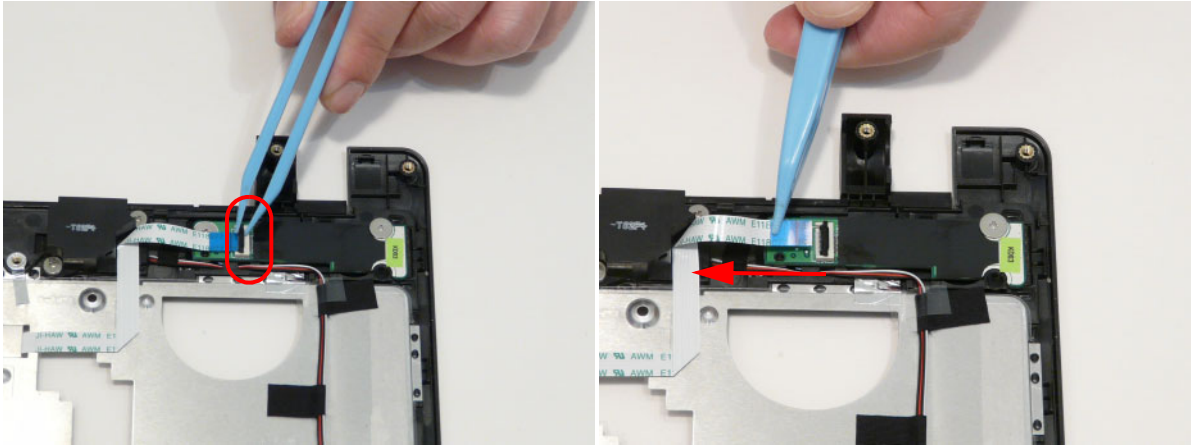

Removing the Power Board

1. See "Removing the Upper Cover" on page 63.
2. Unlock and disconnect the power board FFC.

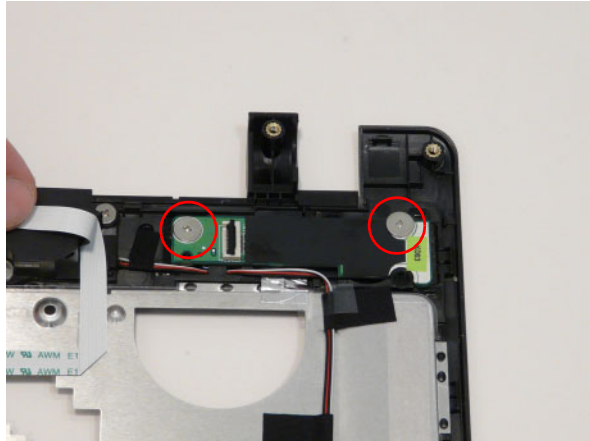

3. Remove the two (2) screws.



Step	Screw	Quantity	Screw Type
Power Board Disassembly	T2.5*2Ni	2	

-
4. Lift the power board away.

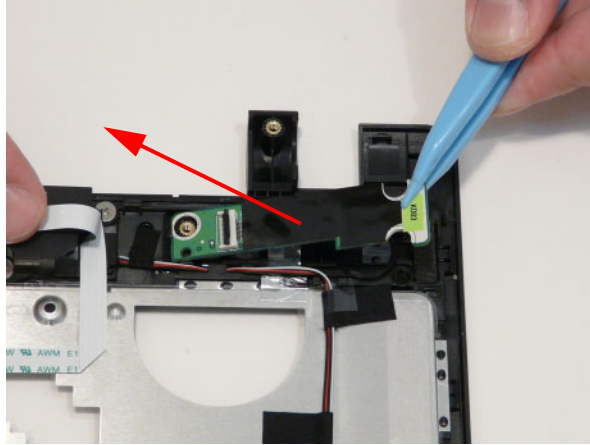

Removing the LCD Module

1. See “Removing the Upper Cover” on page 63.
2. Pull the LCD connector restraining tape off the mainboard.

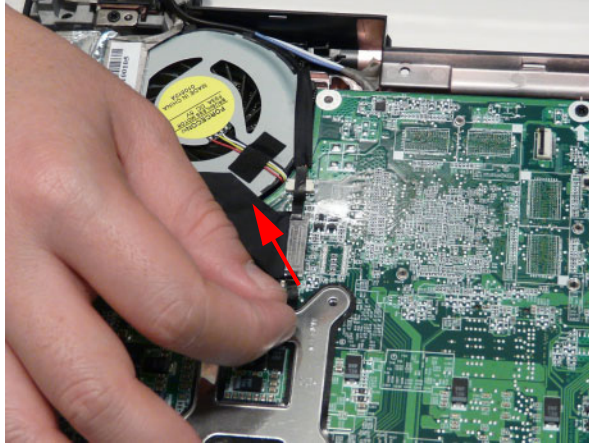

3. Disconnect the LCD connector.

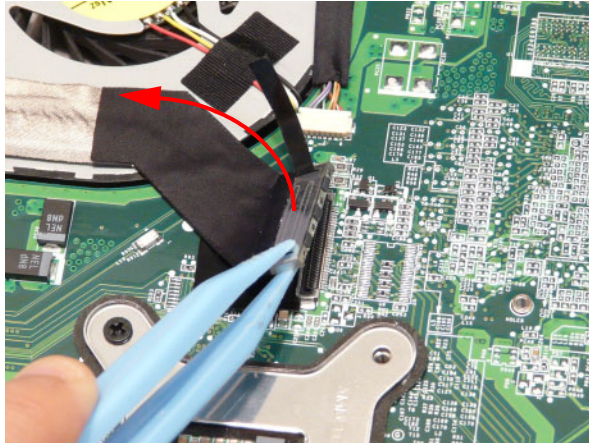

4. Pull the LCD cable off the assembly.

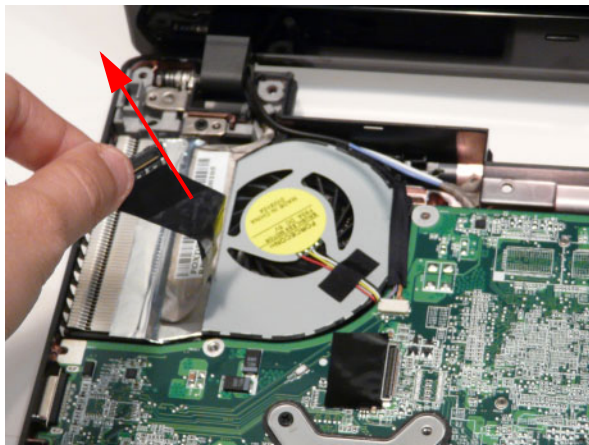

5. Disconnect the microphone connector.

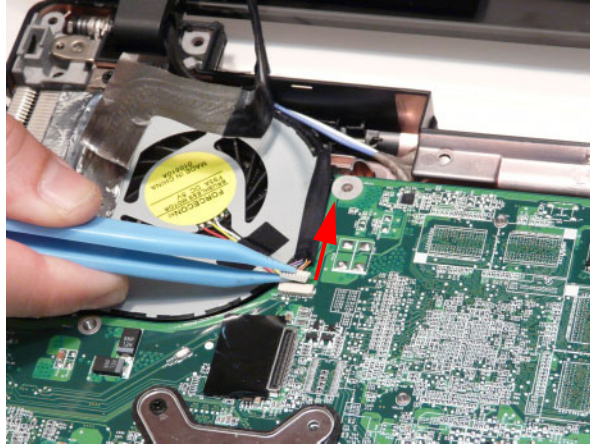

6. Pull the microphone cable off the assembly.

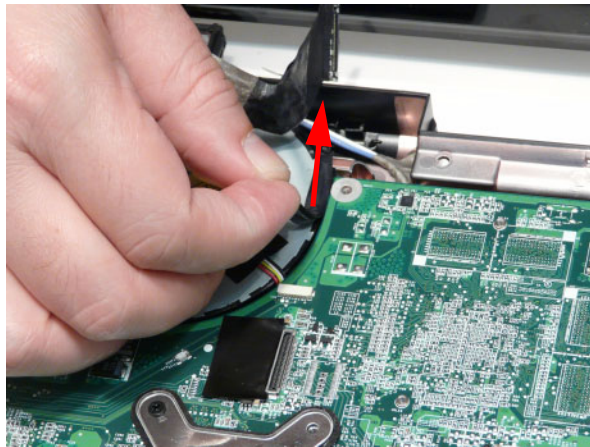

7. Turn the computer over and remove the 3G cable from the retention guides.

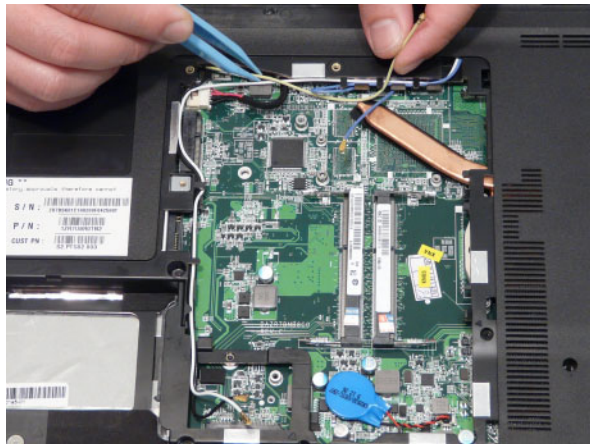

8. Remove the WLAN cables from the retention guides.

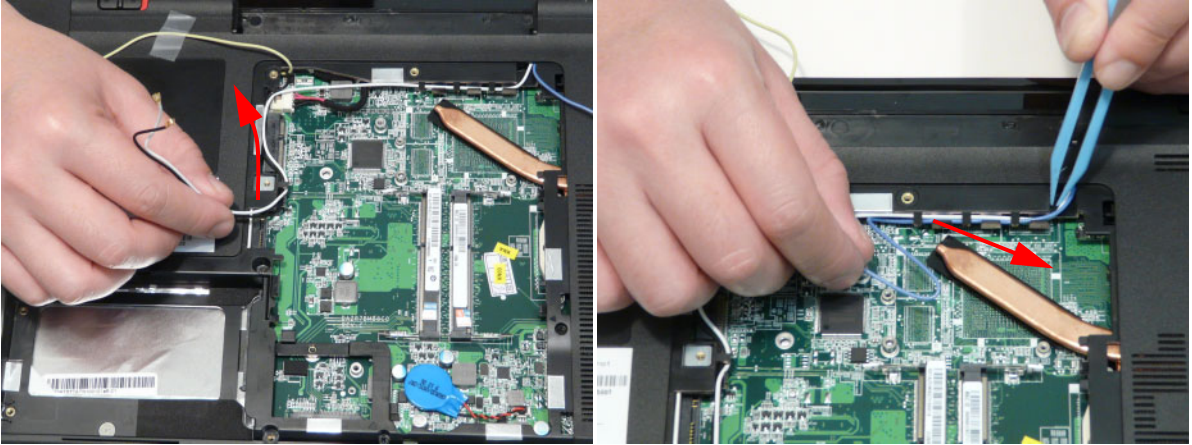

9. Turn the computer over and pull the left antenna cables adhesive tape off the bottom cover.

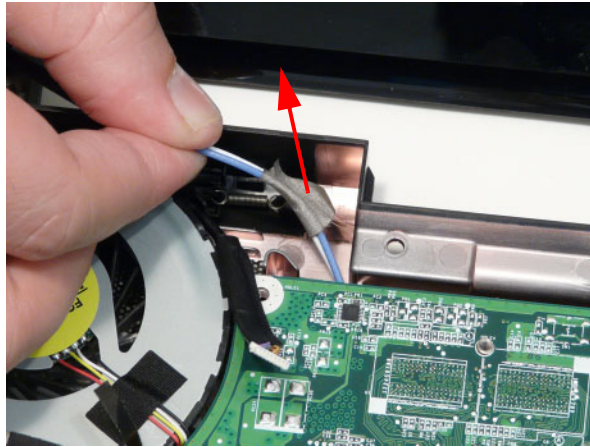

10. Pull the left antenna cables out of the assembly.

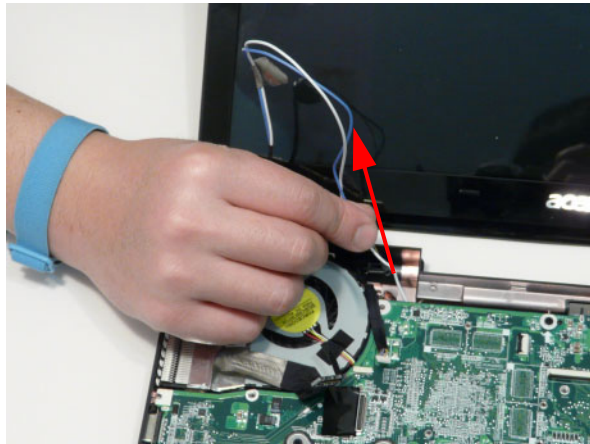

11. Remove the 3G cables adhesive tape.

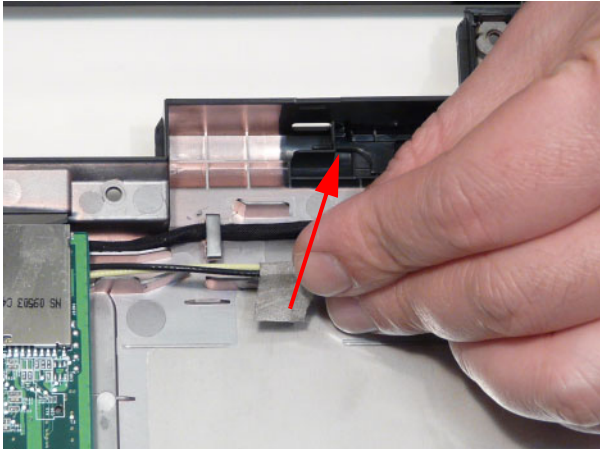

12. Remove the right antenna cables from the retention guide.

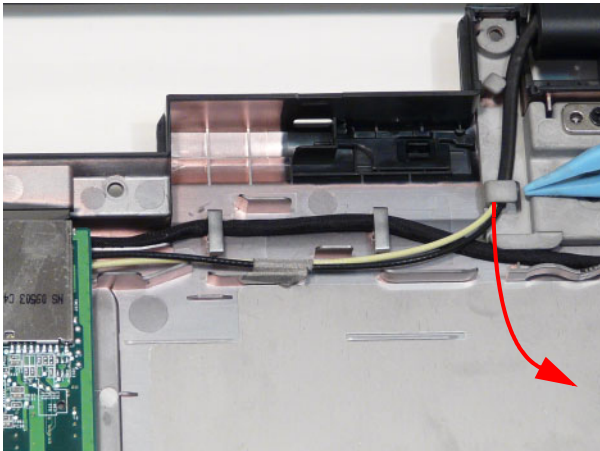

13. Remove the two (2) screws of the two hinges.

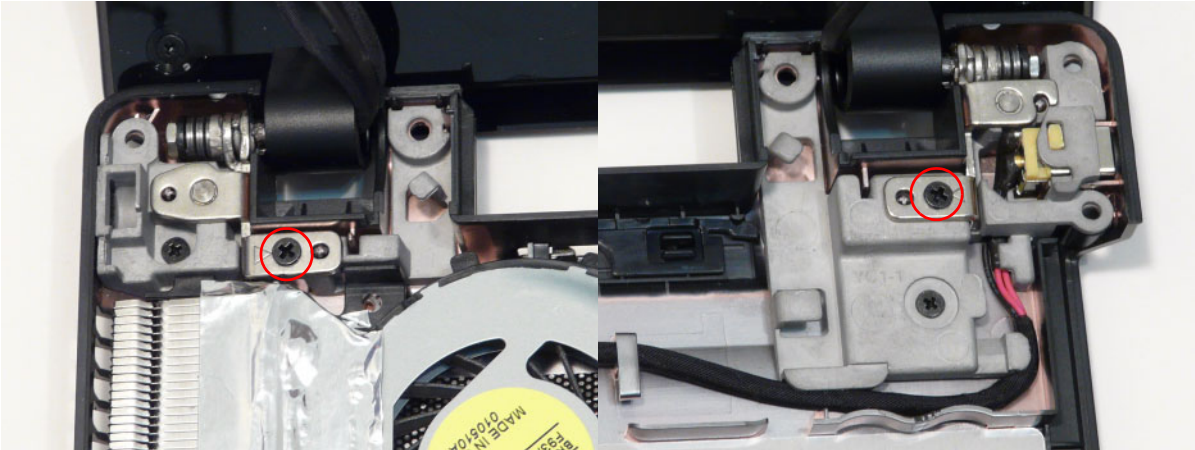

Step	Screw	Quantity	Screw Type
LCD Module Hinge Disassembly	M2.5*5	2	

14. Lift the LCD module out of the assembly.

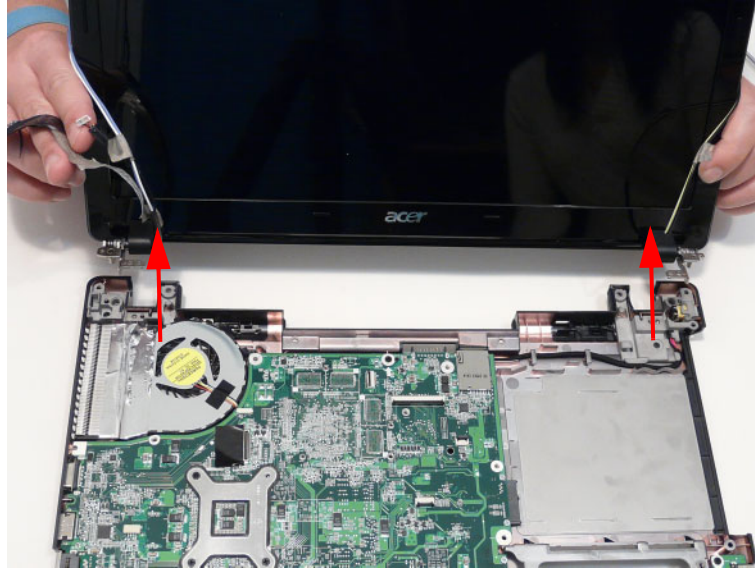

Removing the I/O Board

1. See "Removing the Upper Cover" on page 63.
2. Unlock and remove the I/O board FFC.

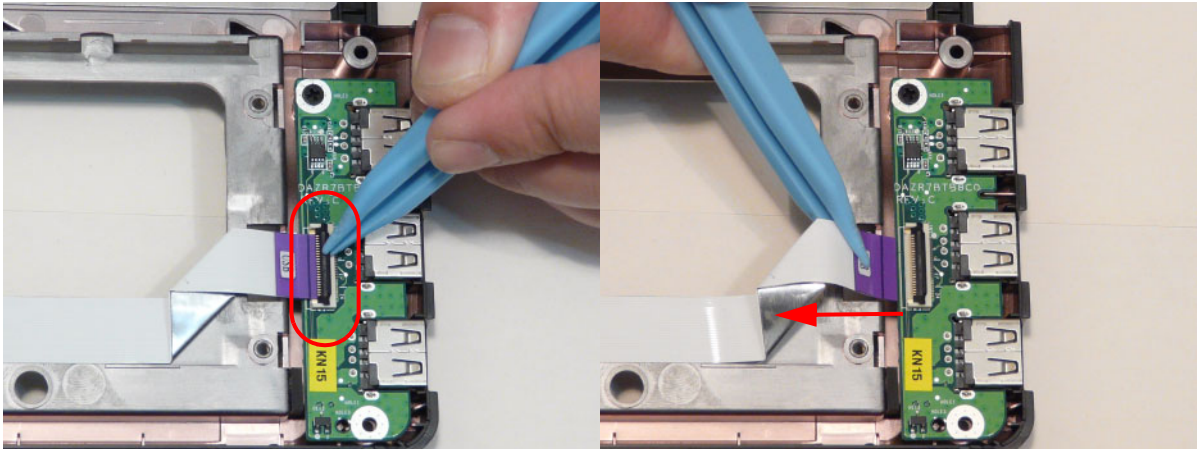

3. Remove the one (1) screw securing the I/O Board to the Lower Cover.

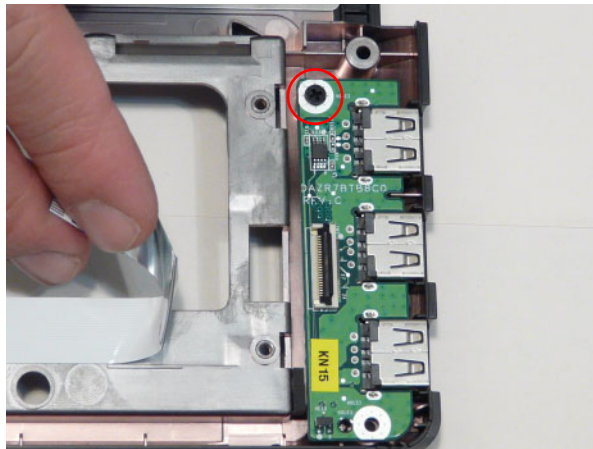

Screw List

Step	Screw	Quantity	Screw Type
I/O Board Disassembly	M2.5*	1	

4. Lift away the I/O board.

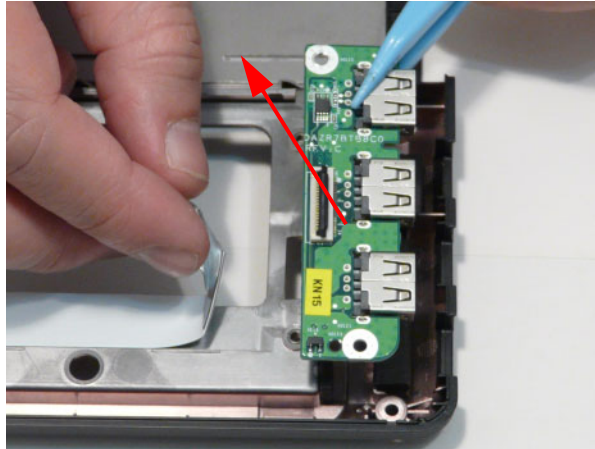

5. Unlock and remove the I/O board FFC from the mainboard.

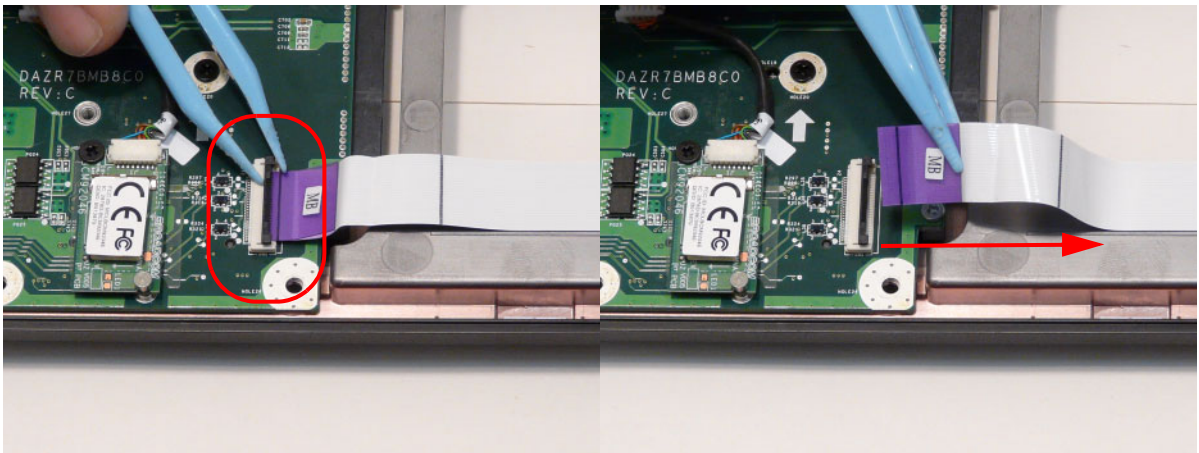

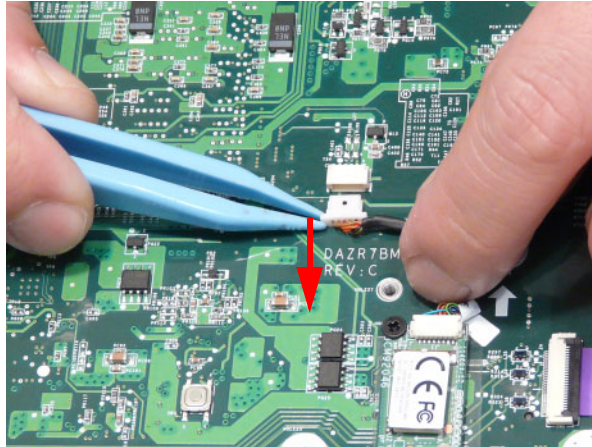

Removing the Bluetooth Module

1. See "Removing the Upper Cover" on page 63.
2. Detach the Bluetooth module cable from the mainboard.

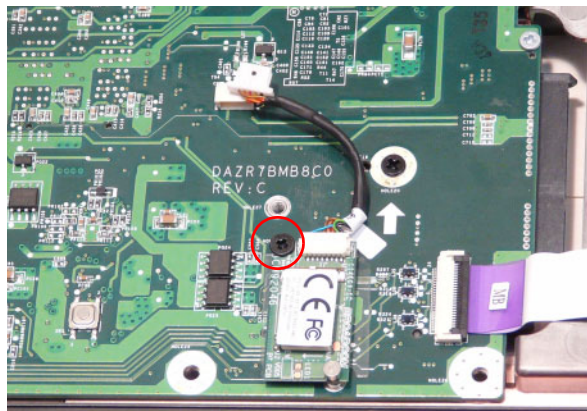

3. Remove the one (1) screw.



Step	Screw	Quantity	Screw Type.
Bluetooth Module Disassembly	M2.5*3	1	

-
4. Lift the Bluetooth module away from the computer.

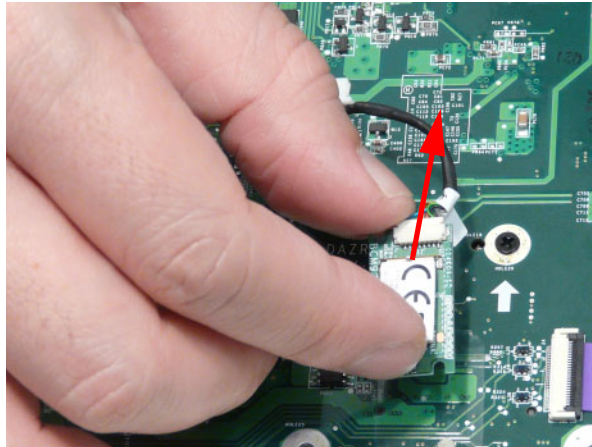

5. Detach the Bluetooth module cable from the module.

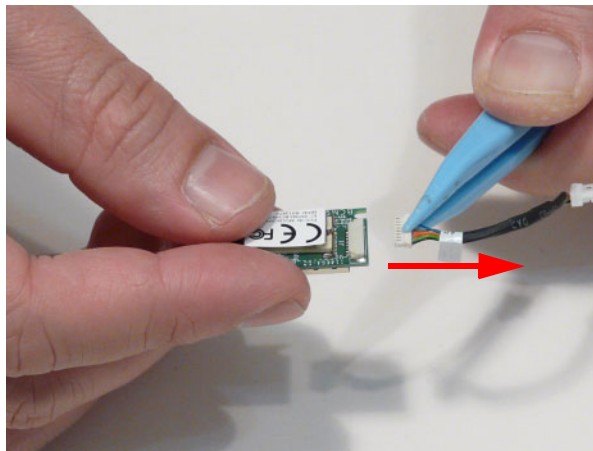

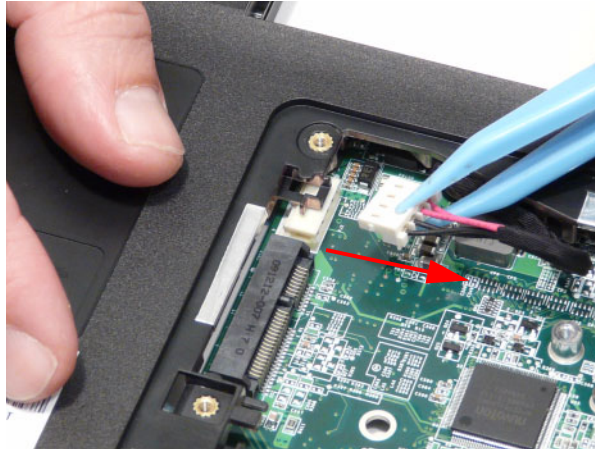

Removing the Mainboard

1. See “Removing the Upper Cover” on page 63.
2. See “Removing the Switch Board” on page 67.
3. See “Removing the I/O Board” on page 76.
4. See “Removing the Bluetooth Module” on page 78.
5. Turn the computer over and disconnect the power cable from the mainboard.

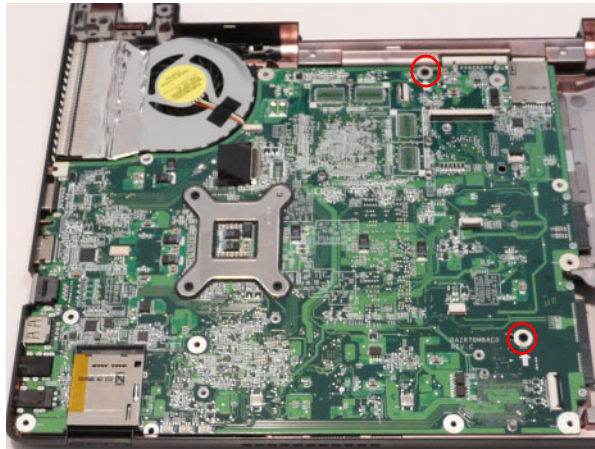

6. Turn the computer over and remove the two (2) screws of the main board.



Step	Screw	Quantity	Screw Type.
Main Board Disassembly	M2.5*5	2	

-
7. Lift the main board out of the assembly. Lift the internal edge up first then pull out the external connector edge.

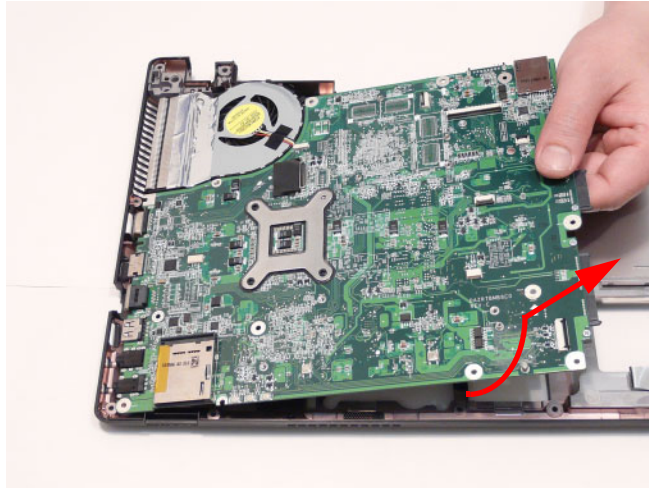

Removing the Thermal Module

1. See “Removing the Mainboard” on page 80.
2. Disconnect the thermal module fan connector.

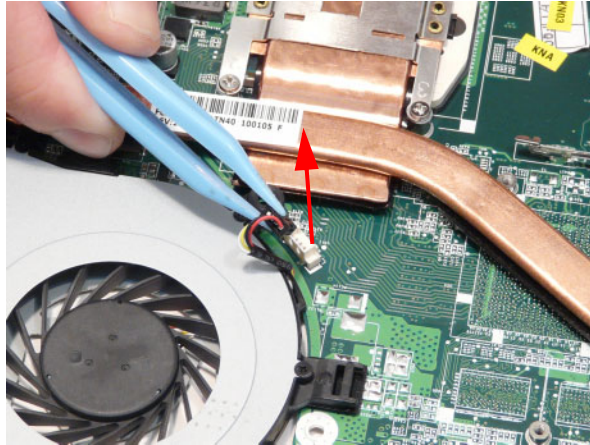

3. Loosen the four (4) captive screws in order: 4, 3, 2, and last 1.1

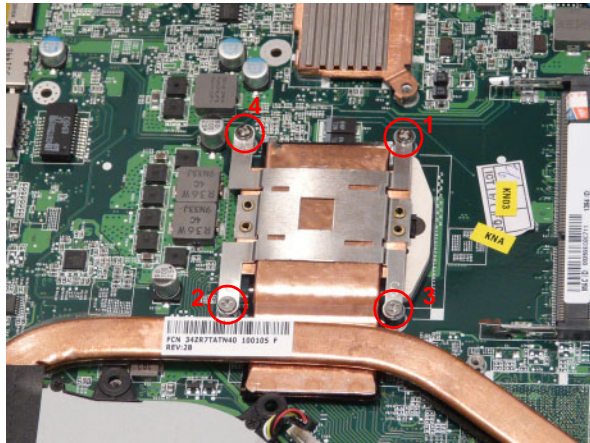

4. Lift the thermal module away from the main board.

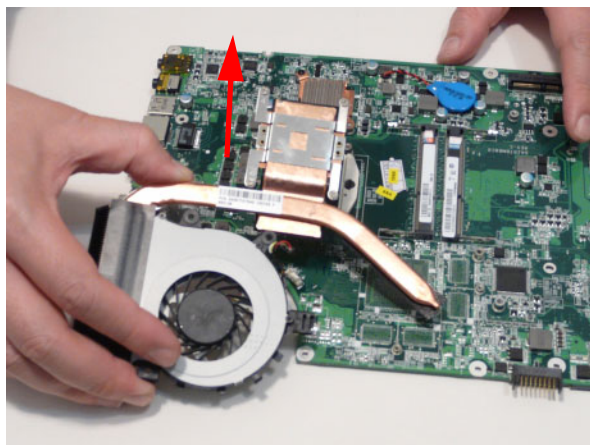

Removing the CPU

1. See “Removing the Mainboard” on page 80.
2. See “Removing the Thermal Module” on page 82.
3. Unlock the CPU. Use a flat head screw driver to turn the screw 180°.

NOTE: The location of the locking lug on the CPU screw.

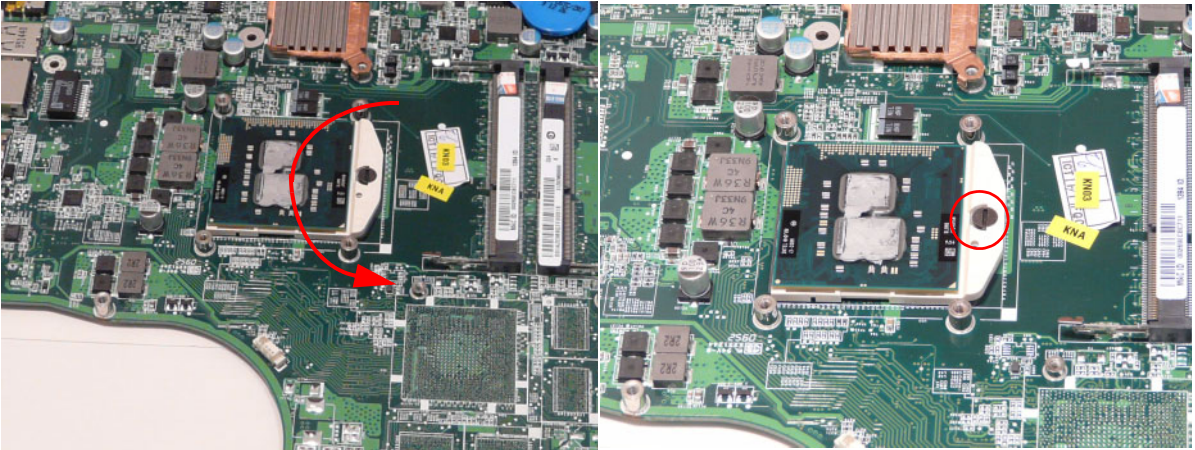

4. Lift the CPU out of the socket.

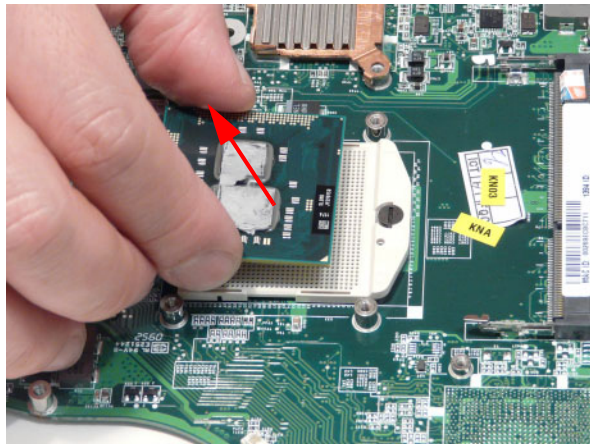

Removing the PCH Thermal Unit

1. See “Removing the Mainboard” on page 80.
2. See “Removing the Thermal Module” on page 82.
3. Loosen the one (1) captive screw.

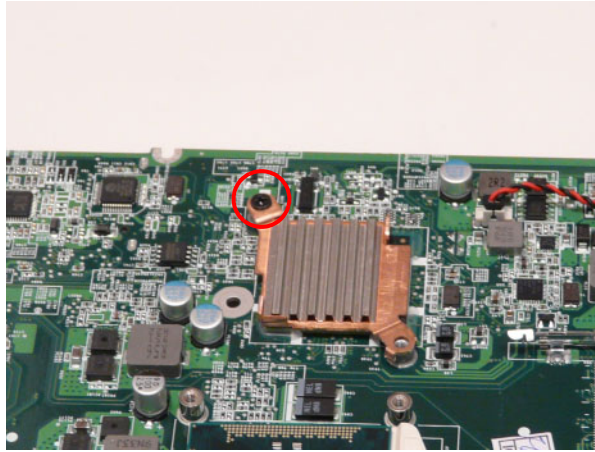

4. Lift the thermal unit away.

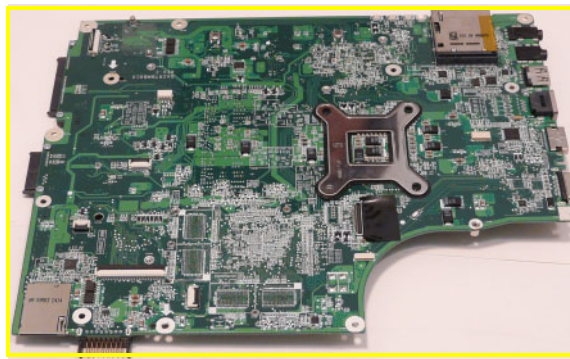
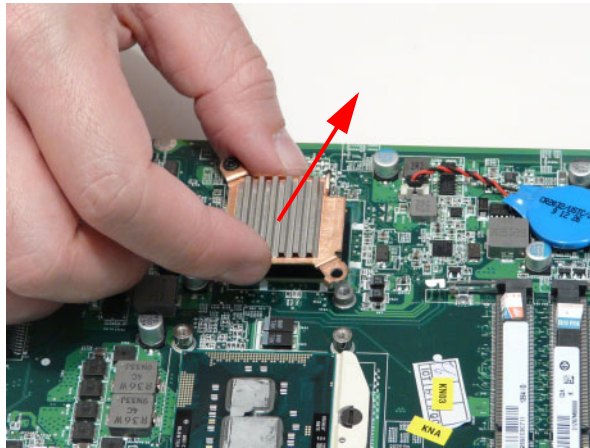

NOTE: Circuit boards >10 cm² have been highlighted with a yellow rectangle as shown in the previous image. Please detach the circuit board and follow local regulations for disposal.

Removing the Power Cable Assembly

1. See "Removing the Mainboard" on page 80.
2. Remove the power cable from the retention guides.

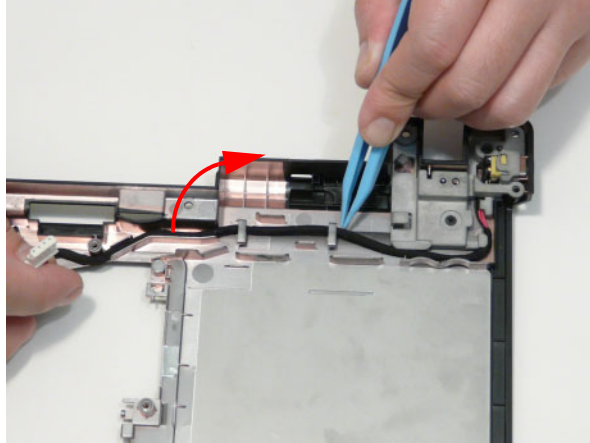

3. Remove the one (1) screw from the power assembly bracket.

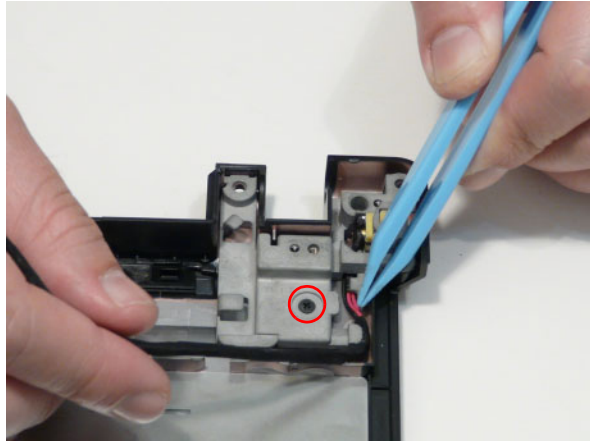

Step	Screw	Quantity	Screw Type
Power Assembly Disassembly	M2.5*4	1	

-
4. Lift the power cable assembly out of the chassis.

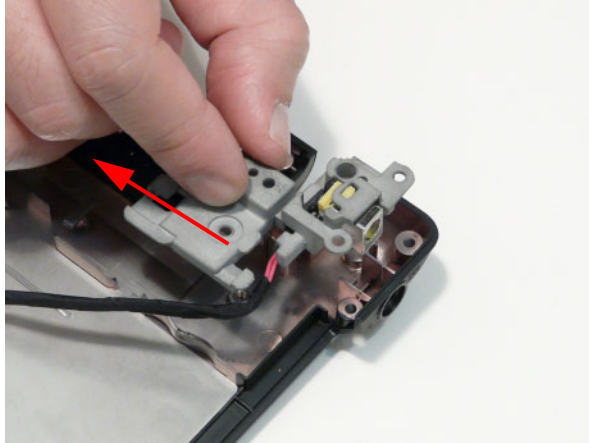

5. Lift the power cable connector out of the bracket.

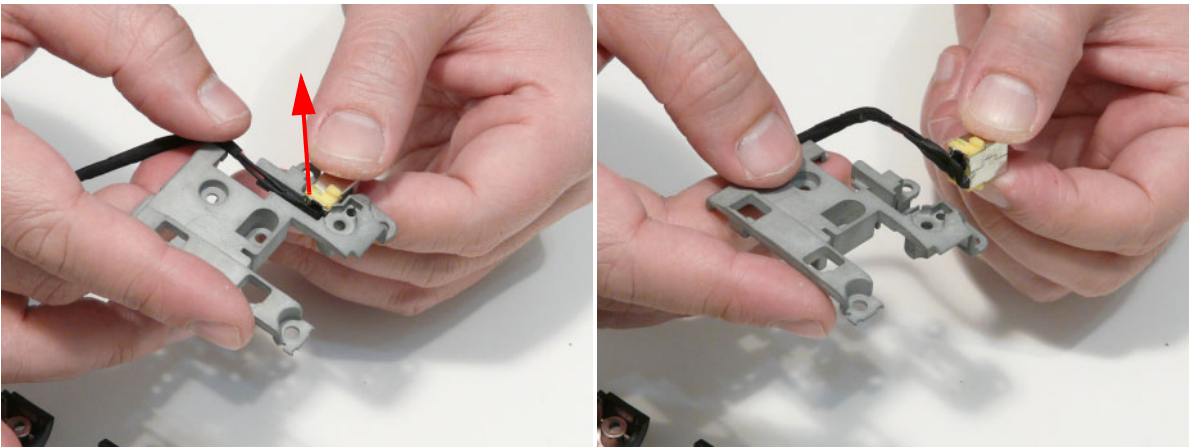

LCD Module Disassembly Process

IMPORTANT: Cable paths and positioning may not represent the actual model. During the removal and replacement of components, ensure all available cable channels and clips are used and that the cables are replaced in the same position.

NOTE: The product previews seen in the disassembly procedures may not represent the final product color or configuration.

LCD Module Disassembly Flowchart

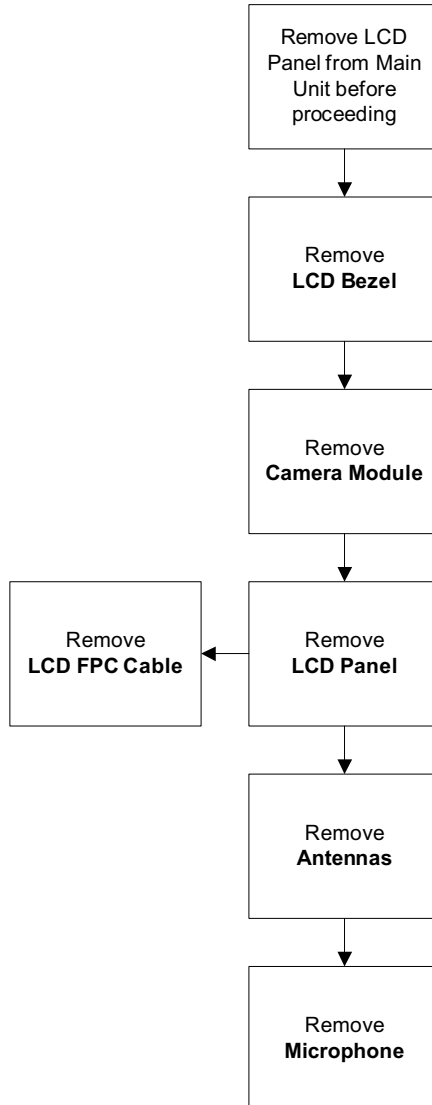

Screw List

Step	Screw	Quantity	Part No.
LCD Bezel Disassembly	M2.5*4	2	86.PTN07.004
LCD Panel Disassembly	M2.5*3	4	86.A08V7.005
Left Hinge Disassembly	M2.5*3	2	86.PTN07.003

Step	Screw	Quantity	Part No.
Right Hinge Disassembly	M2.5*3	2	86.PTN07.003

Removing the LCD Bezel

- 1. See "Removing the Switch Board" on page 67.
- 2. Remove the two (2) bezel screw covers and screws.



Step	Screw	Quantity	Screw Type
LCD Bezel Disassembly	M2.5*4	2	

- 3. Pry the bezel away from the top and then work around one corner.

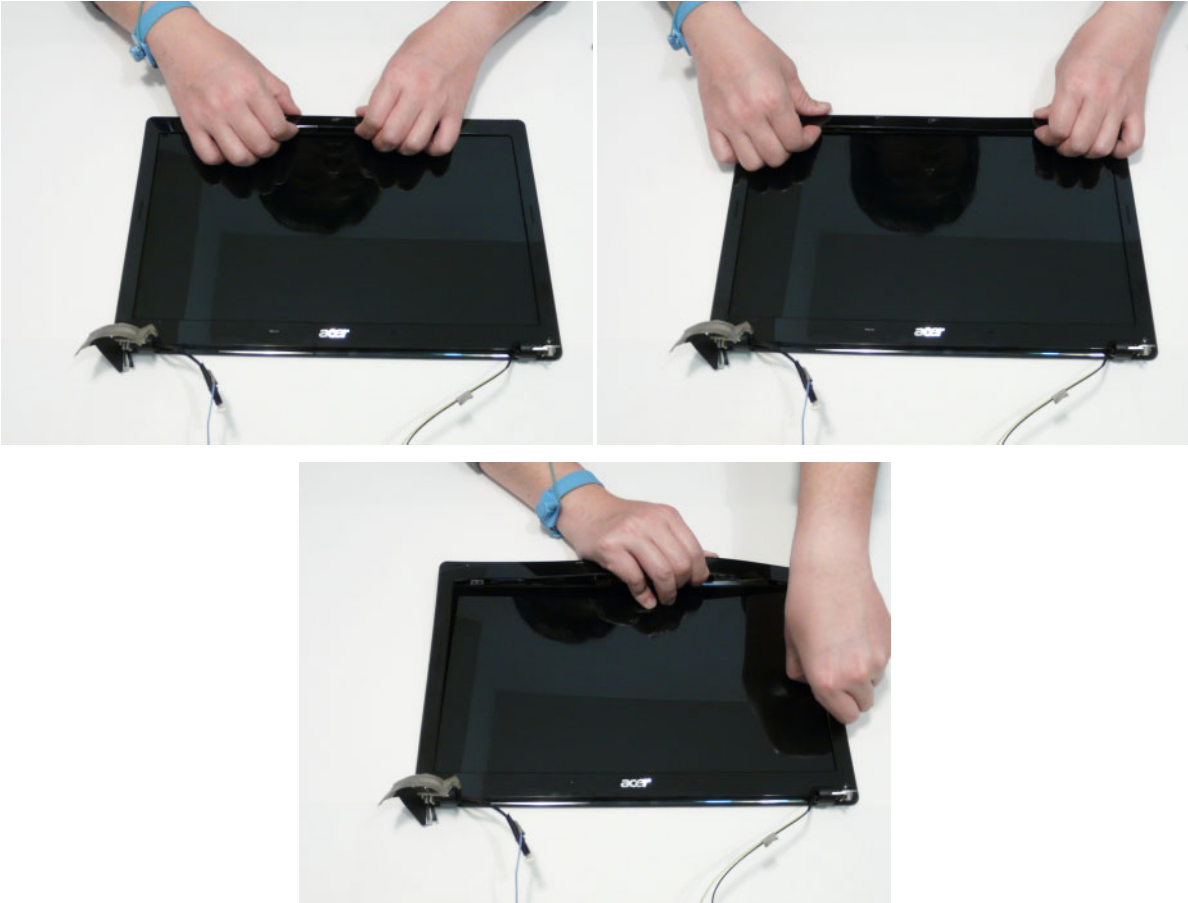

-
4. Pry open the bottom corners and along the bottom edge.

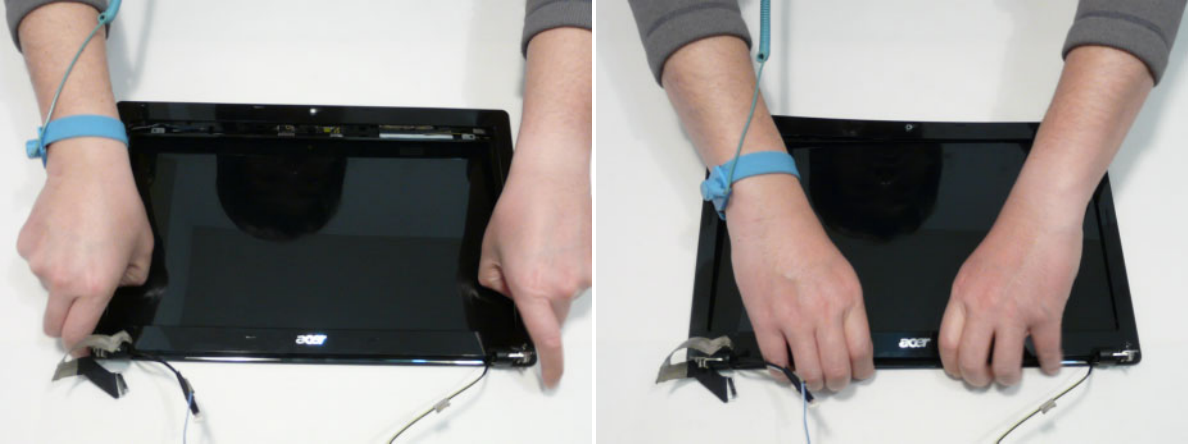

5. Lift the bezel off the module.



Removing the Camera Board

1. See "Removing the LCD Bezel" on page 89.
2. Disconnect the camera connector.



3. Pull up the camera board.

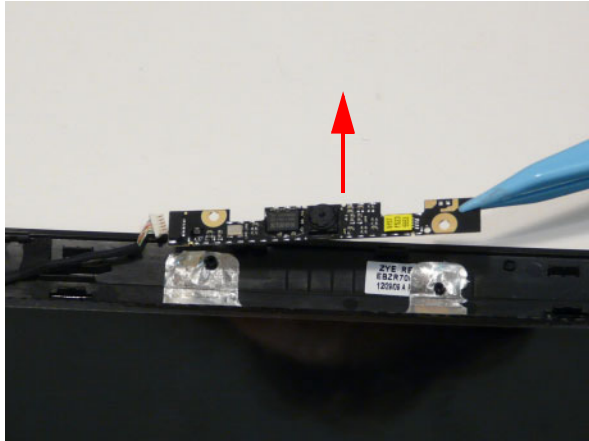

Removing the LCD Panel

1. See "Removing the Camera Board" on page 91.
2. Remove the four (4) screws of the LCD panel.



Step	Screw	Quantity	Screw Type
LCD Panel Disassembly	M2.5x3	4	

3. Remove the two (2) screws in the left hinge.



Screw List

Step	Screw	Quantity	Screw Type
Remove Left Hinge	M2.5x3	2	

4. Lift the left hinge off the module.

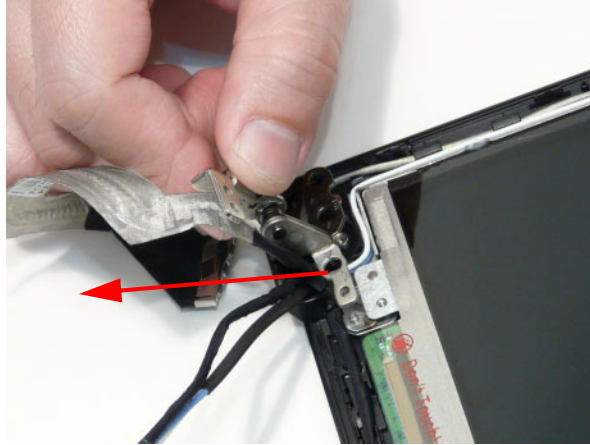

5. Lift the LCD panel out.

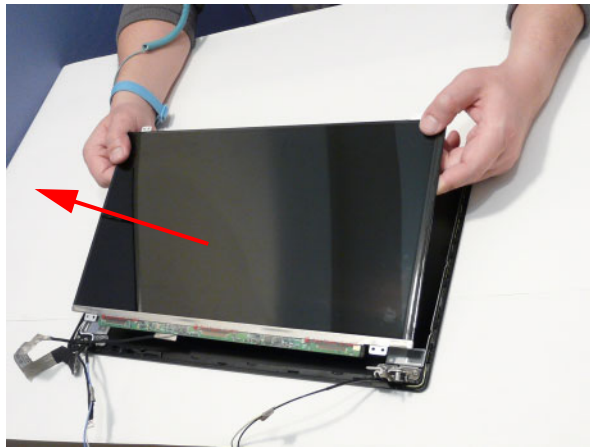

6. Lift the LCD panel out, turn over and remove the protective tape over the FPC cable connector.

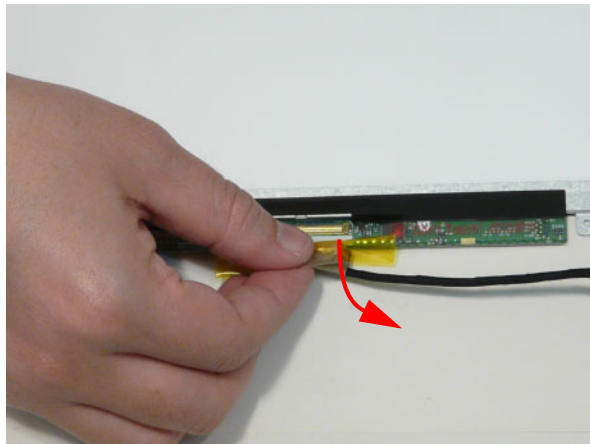

7. Disconnect the FPC cable.

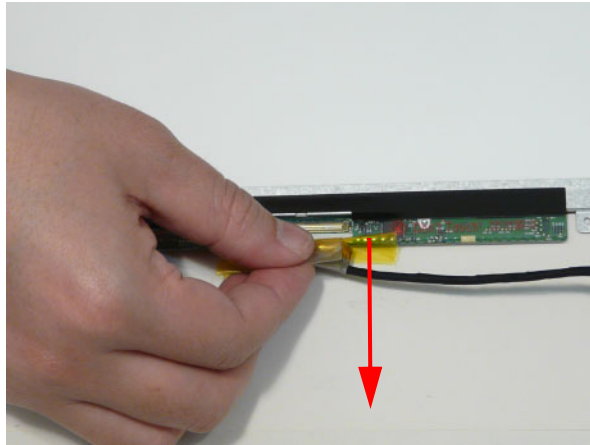

Removing the Antennas

1. See "Removing the LCD Panel" on page 92.
2. Remove the cable from the retention guides.

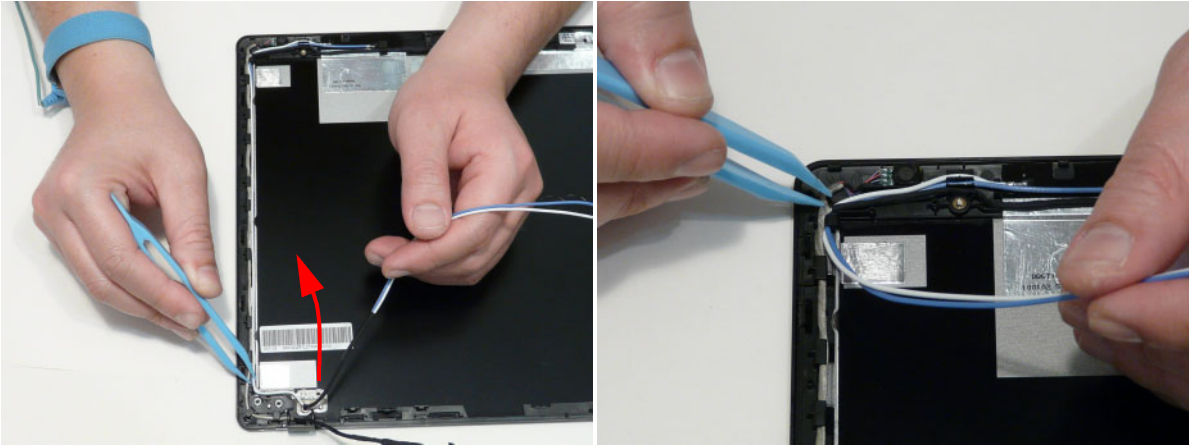

3. Free the cables completely.

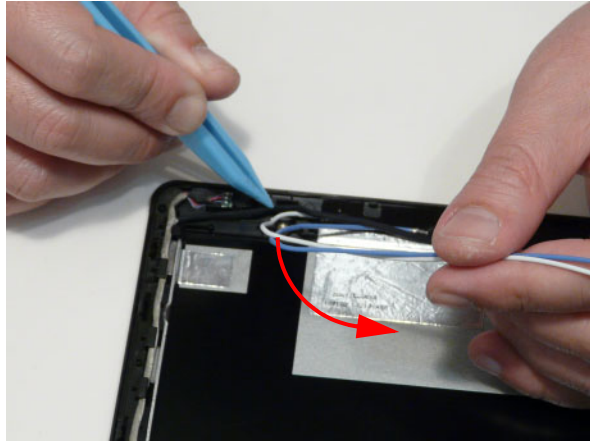

4. Pull up the camera cable adhesive tape.

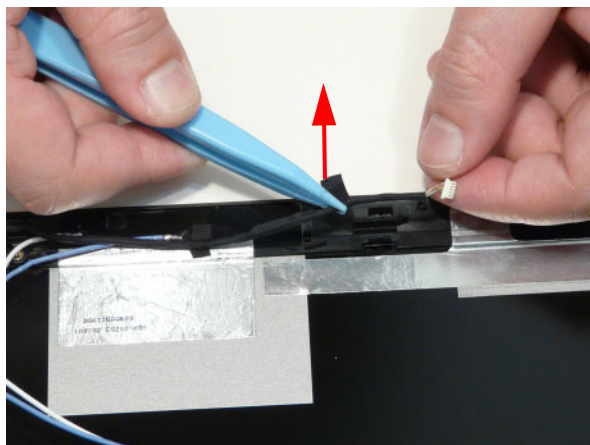

5. Pry the antenna off the casing.



6. Remove the two (2) screws of the right hinge.



Step	Screw	Quantity	Screw Type
Right Hinge Disassembly	M2.5*3	2	

7. Lift away the hinge.

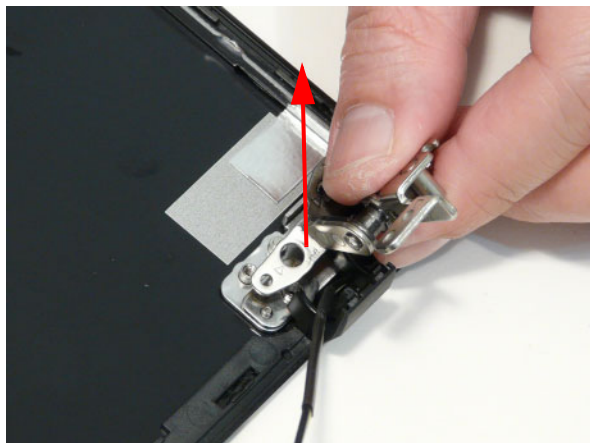

-
8. Remove the cable from the retention guides.

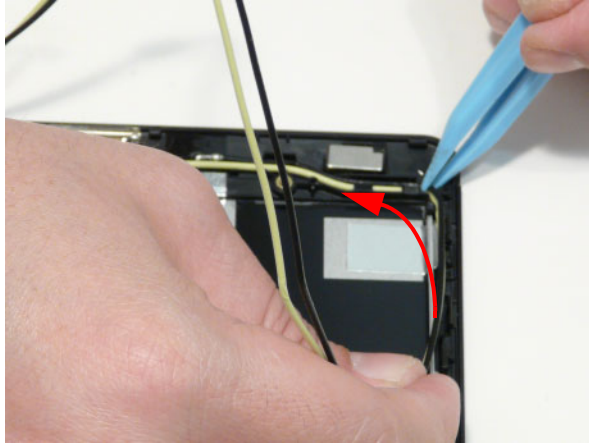

9. Pry the antenna off the casing.

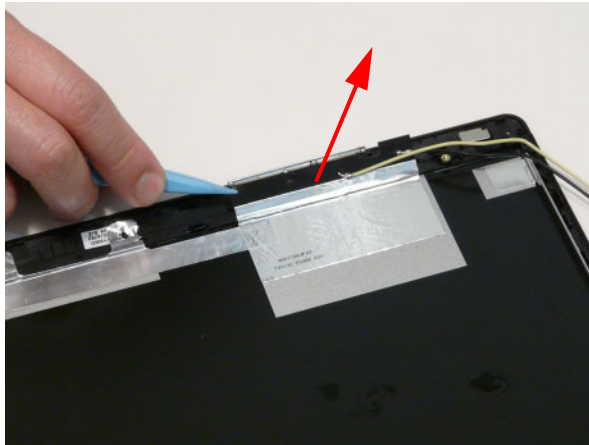

Removing the Microphone Cable

1. See "Removing the Antennas" on page 95.
2. Pry the microphone up.

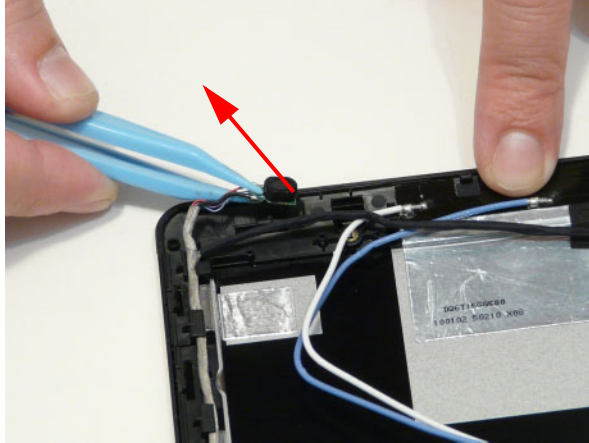

3. Lift the microphone cable out of the retention guides.

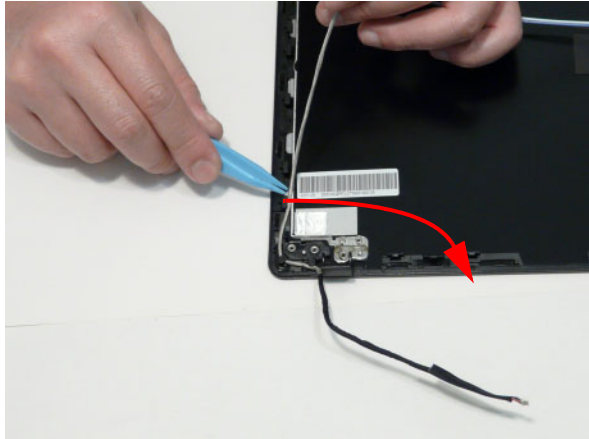

LCD Reassembly Procedure

NOTE: Adhesive is required to be added at various steps to cables and components. Locations of adhesive to be added is designated with a: ●

NOTE: During manufacture a cyanoacrylate glue is used provided by Holdtite Adhesives LTD. This is not a specified requirement. The reassembler is free to select an alternative appropriate adhesive.

Replacing the Microphone

1. Lay the microphone cable in the retention guides.

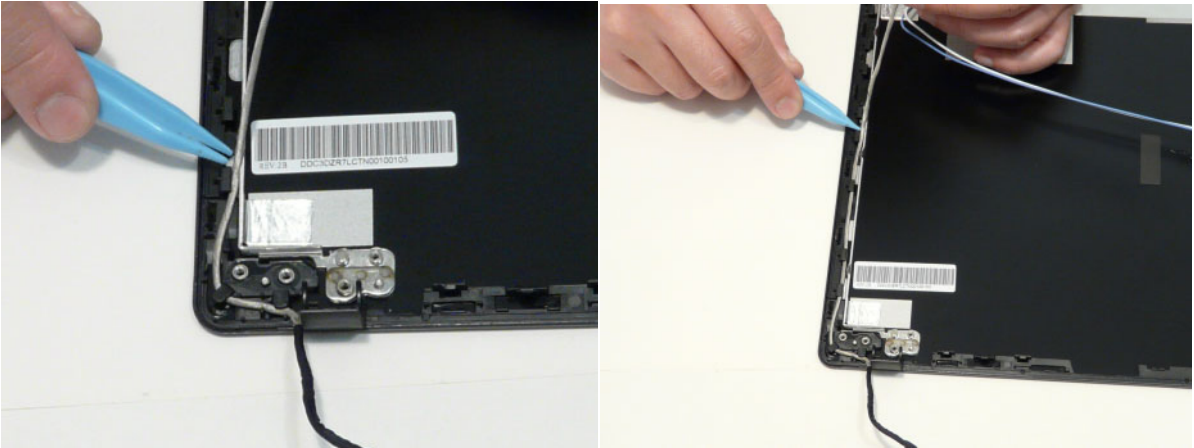

2. Adhere the microphone.

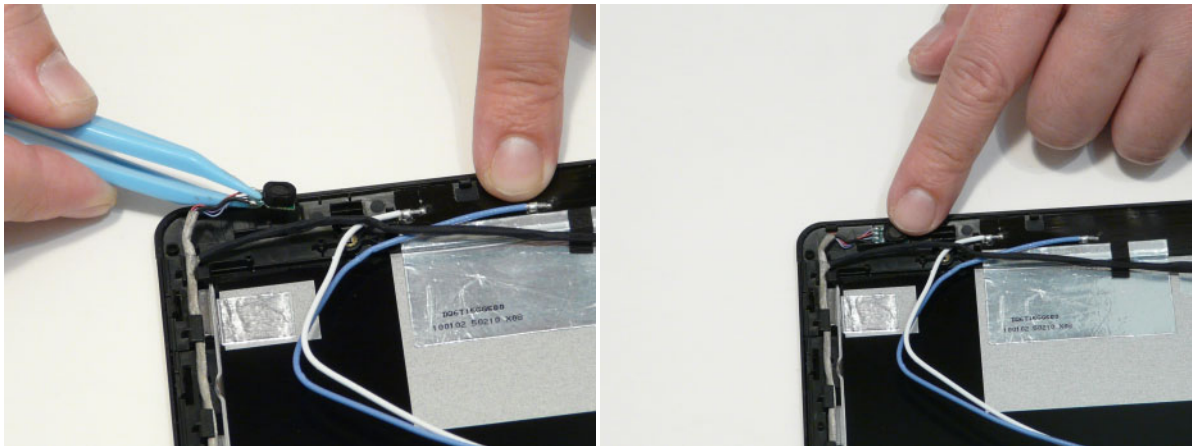

Replacing the Antennas

1. See See “Replacing the Microphone” on page 99.

2. Adhere the antenna down firmly onto the LCD module casing.

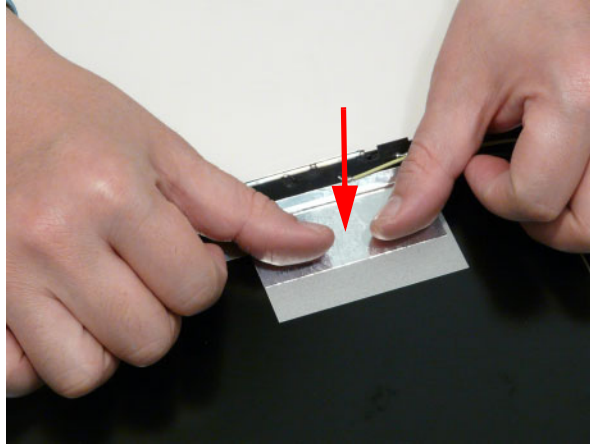

3. Lay the cables around the module edge for the right antenna.

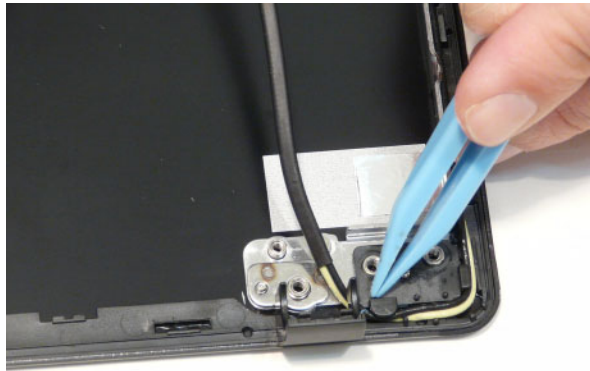
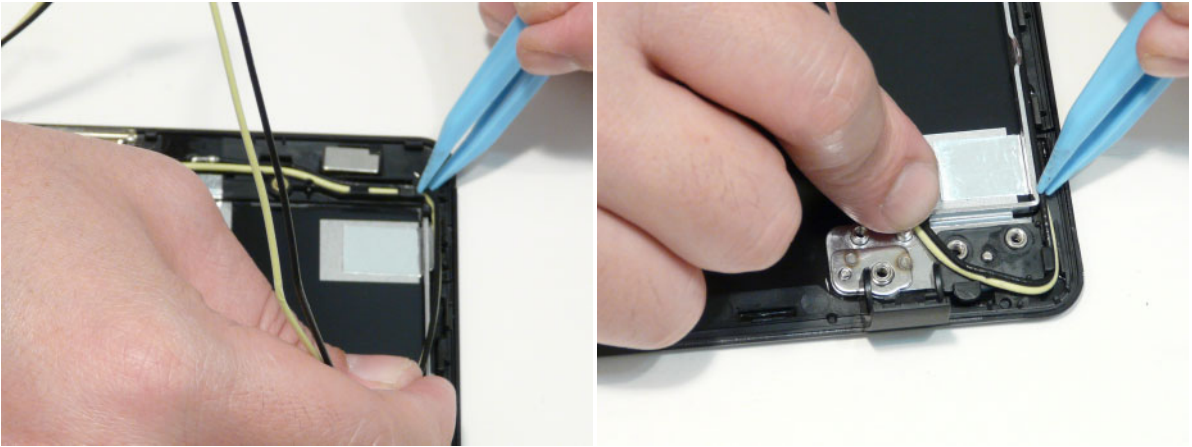

4. Replace the right hinge.

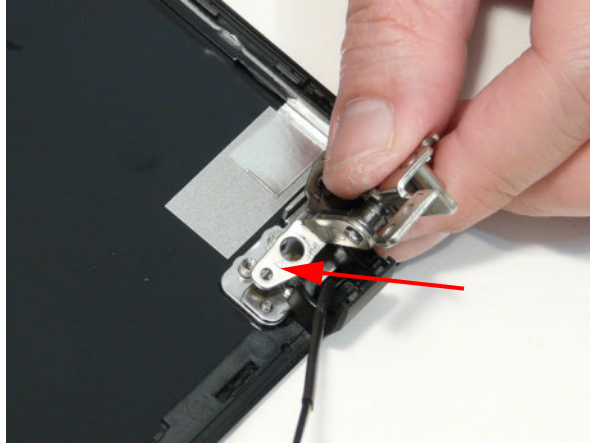

Step	Screw	Quantity	Screw Type
Replace Right Hinge	M2.5*3	2	

5. Replace the two (2) screws. Ensure that the cable is coming out of the hinge correctly.



6. Adhere the left antenna to the casing, pressing firmly down on the foil and antenna.

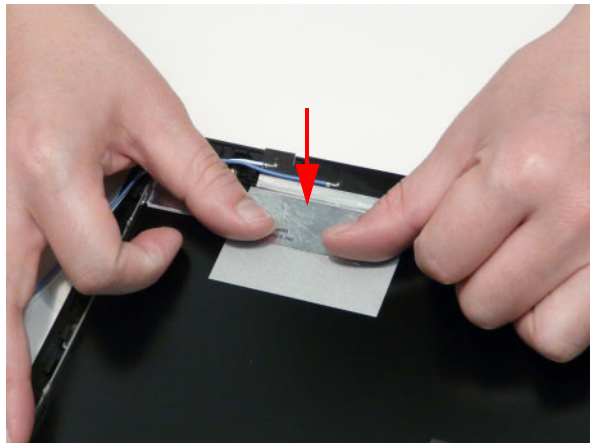

7. Lay the cables along the retention guides.

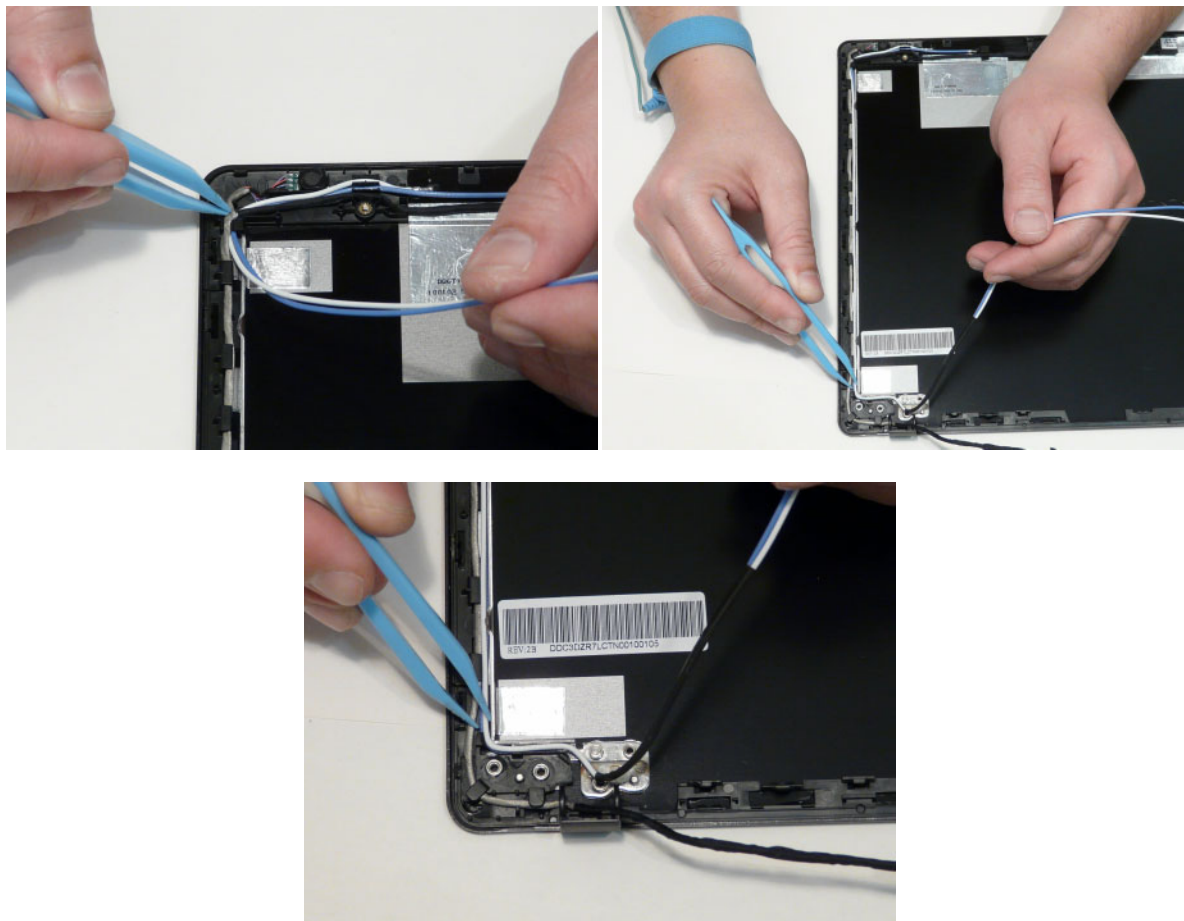

Replacing the LCD FPC Cable

1. Connect the FPC cable connector.

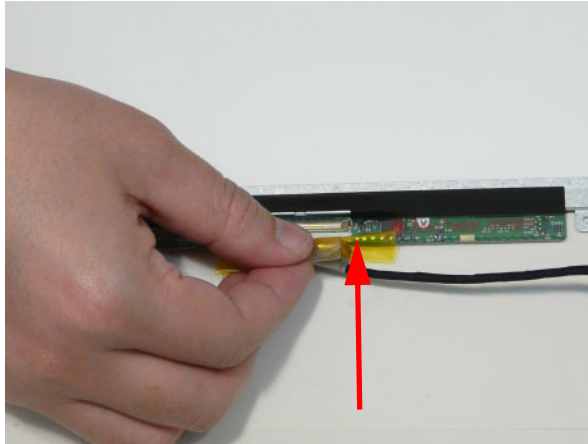

2. Place the protective clear adhesive mylar tape down firmly over the connector.

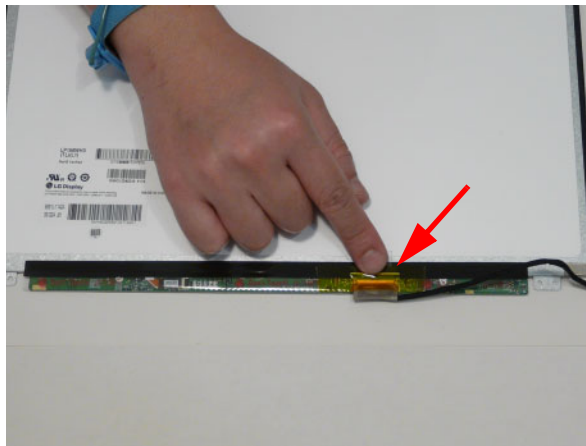

Replacing the LCD Panel

1. Place the LCD panel into LCD module as shown top edge first, making sure the cable is not trapped behind the panel.

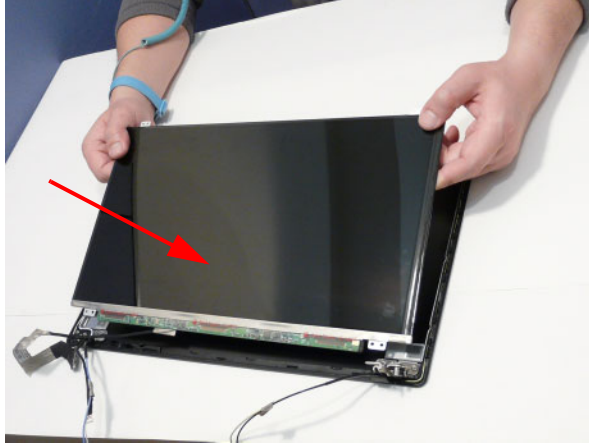

2. Place the left hinge onto the LCD module.

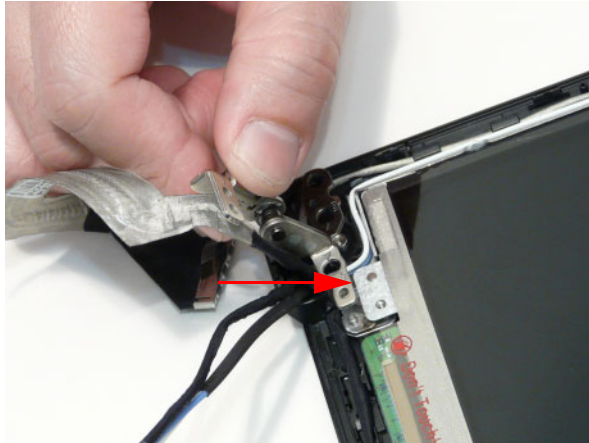

3. Replace the two (2) screws, while ensuring the cables pass through the hinge correctly.



Step	Screw	Quantity	Screw Type
Replace Left Hinge	M2.5*3	2	

Replacing the Camera Board

1. Replace the camera cable and adhere the tapes.

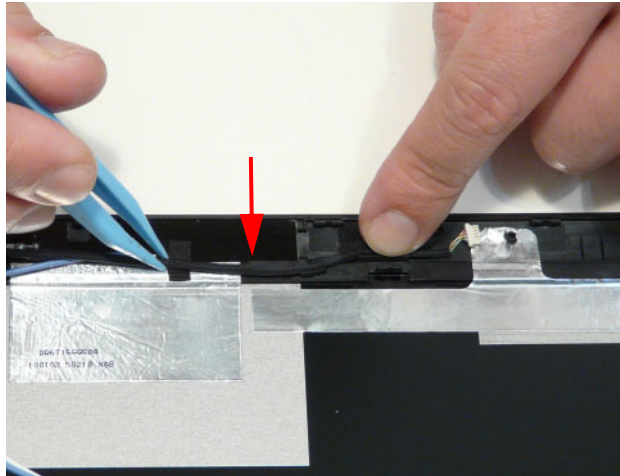

2. Apply adhesive and lay the Camera Board board down pressing firmly.

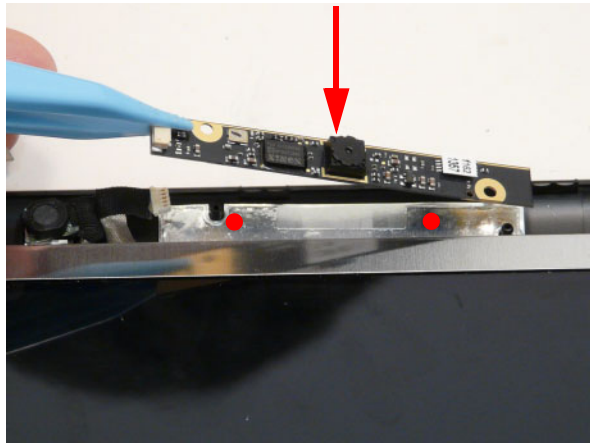

3. Connect the cable to the Camera Board.

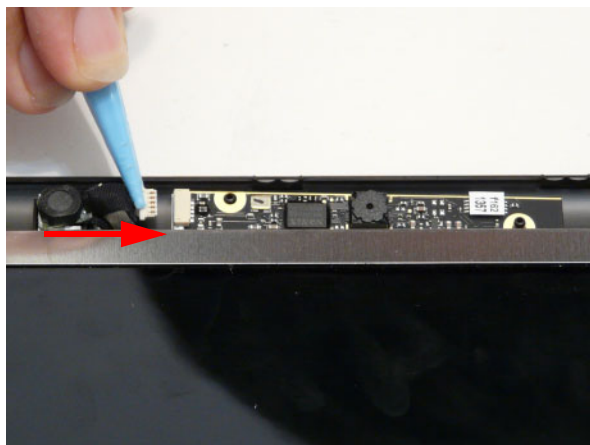

Replacing the LCD Bezel

1. Place the bezel hinge covers over the hinges. Ensure the cables are correctly exiting the hinges.



2. Press down on the top middle edge of the bezel to engage the locking clips.



3. Press down on the bezel edge working simultaneously around the edges to the bottom.

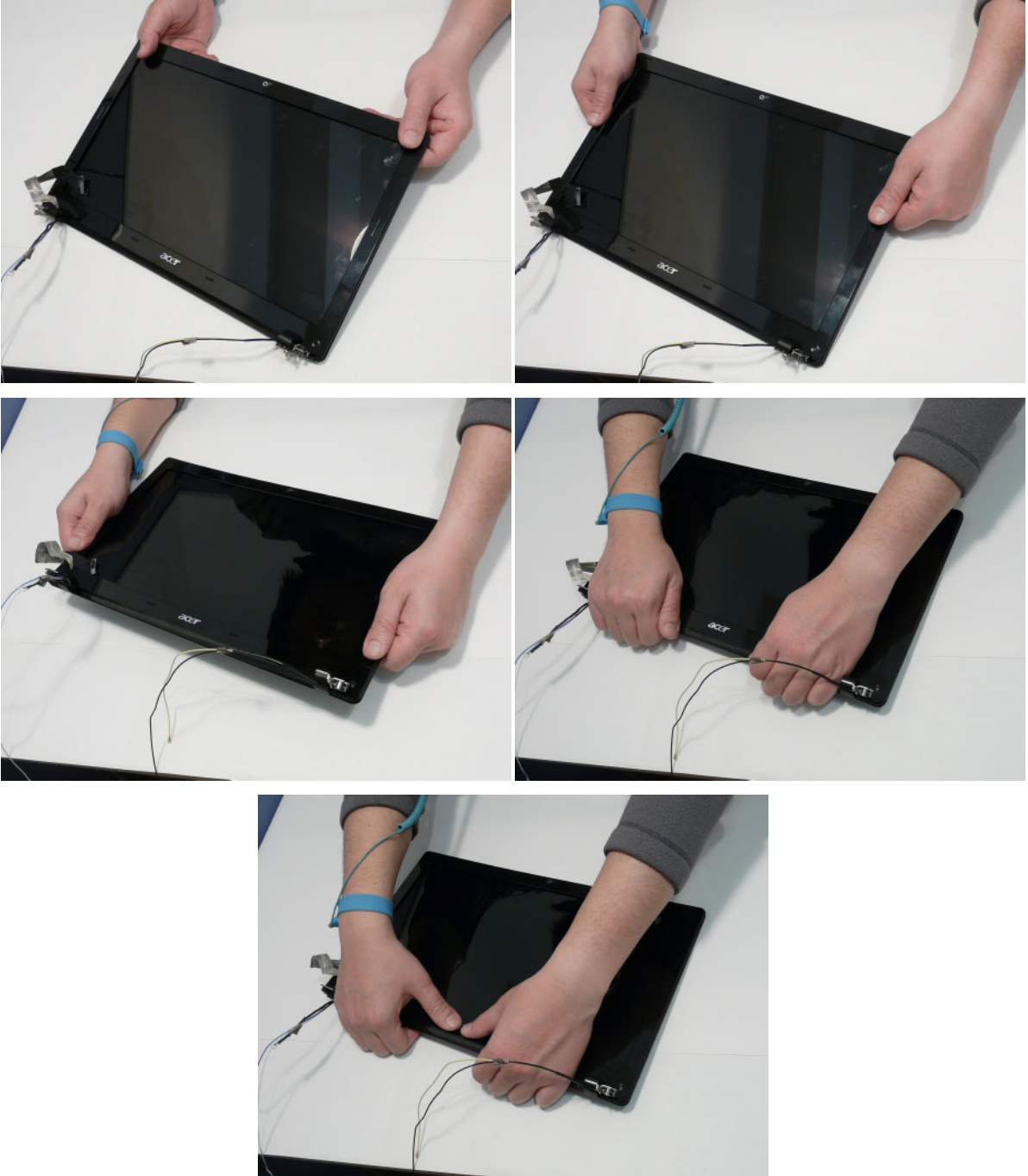

-
4. Replace the two (2) bezel screws and screw covers.



Step	Screw	Quantity	Screw Type
Replace LCD Bezel	M2.5*4	2	

Main Unit Reassembly Process

Replacing the Power Assembly

1. Place the power jack into the bracket.

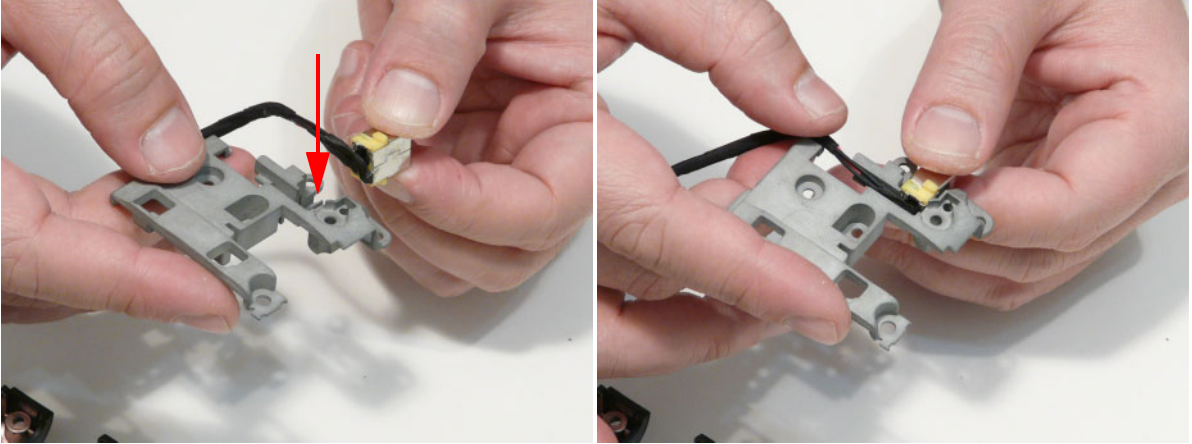

2. Place the bracket into the lower cover.

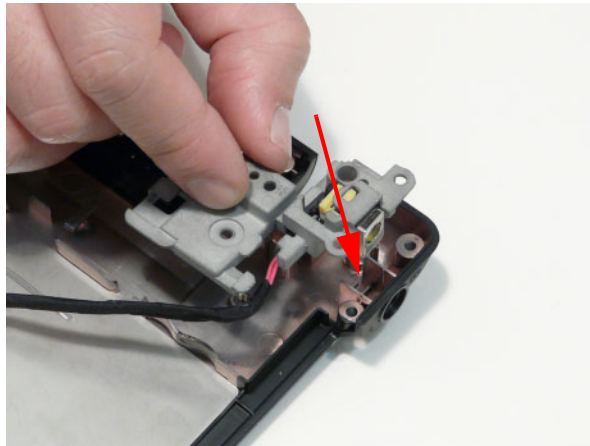

3. Replace the one (1) screw.

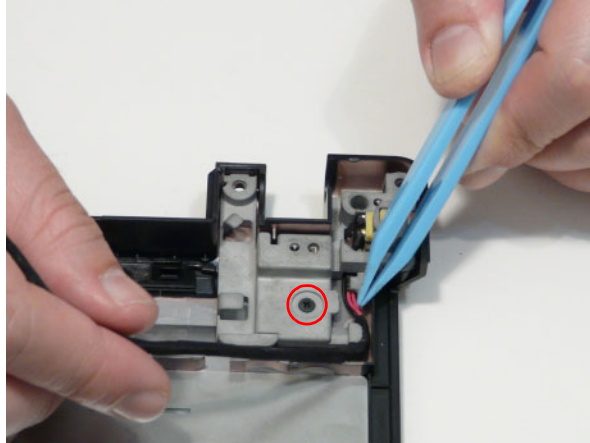

Step	Screw	Quantity	Screw Type
Replace Power Assembly	M2.5*4	1	

4. Lay the cables in the retention guides.

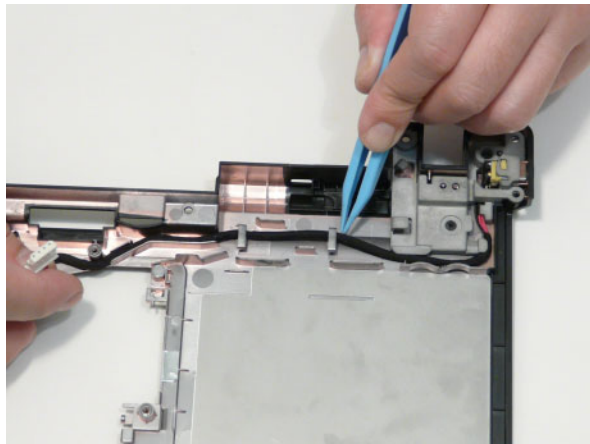

Replacing the PCH Thermal Module

1. Place the PCH thermal module on the chip.

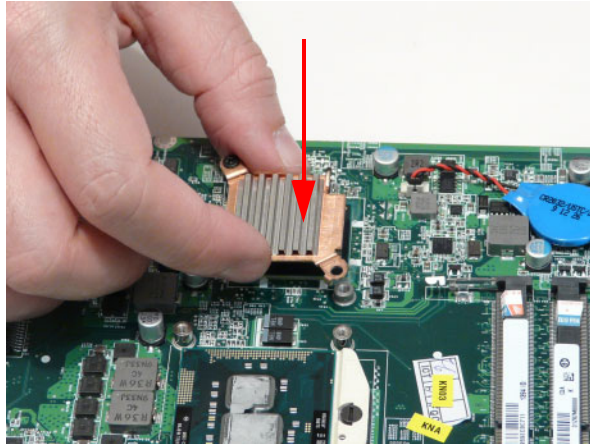

2. Tighten the one (1) captive screw.

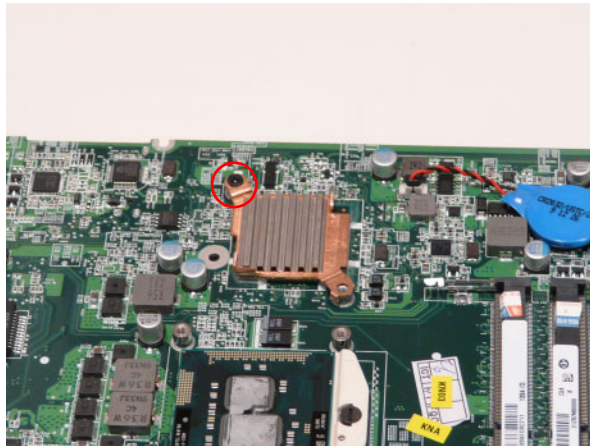

Replacing the CPU

IMPORTANT: The CPU has a Pin1 locator that must be positioned corresponding to the marker on the CPU socket.

1. Place the CPU into the CPU socket as shown, taking note of the Pin1 locator.

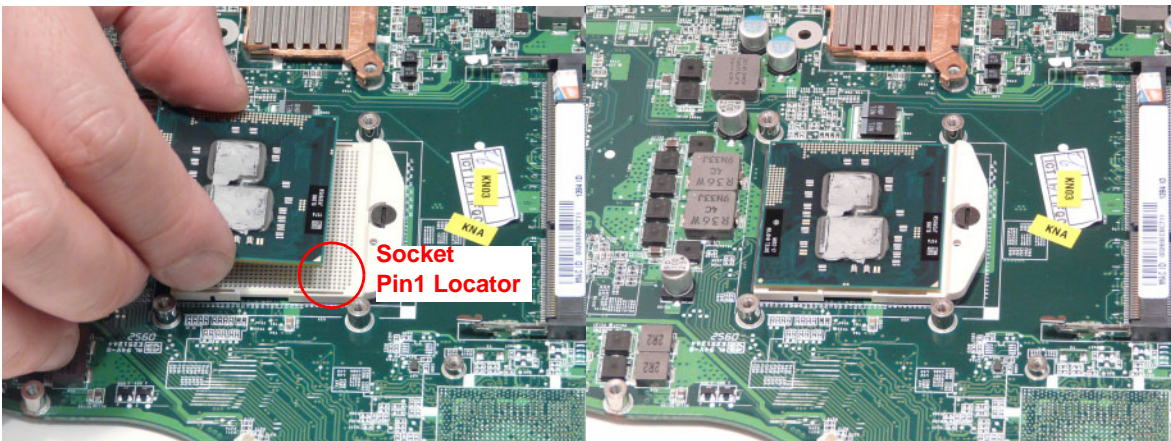

-
- Using a flat-bladed screw driver, rotate the CPU locking screw 180° clockwise to secure the CPU in place.

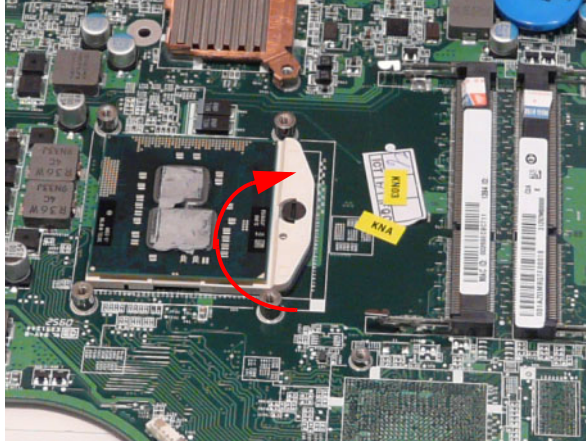

Replacing the Thermal Module

IMPORTANT: Apply a suitable thermal grease and ensure all heat pads are in place before replacing the Thermal Module.

The following thermal grease types are approved for use:

- Silmore GP50
- Honeywell
- Jet Motor 7762

The following thermal pads are approved for use:

- Eapus XR-PE
1. Remove all traces of thermal grease from the CPU using a lint-free cloth or cotton swab and Isopropyl Alcohol, Acetone (1), or other approved cleaning agent.
 2. Apply a small amount of thermal grease to the centre of the CPU—there is no need to spread the grease manually, the force used during the installation of the Thermal Module is sufficient.
 3. Align the screw holes on the Thermal Module and Mainboard then replace the module. Keep the module as level as possible to spread the thermal grease evenly.
 4. Replace the four (4) securing screws (in numerical order from screw 1 to screw 4) to secure the Thermal Module in place.

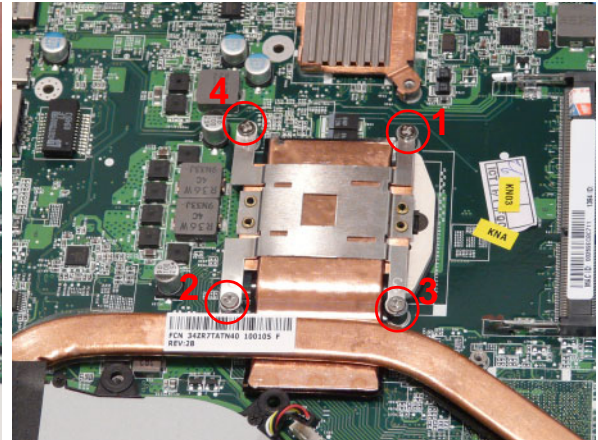
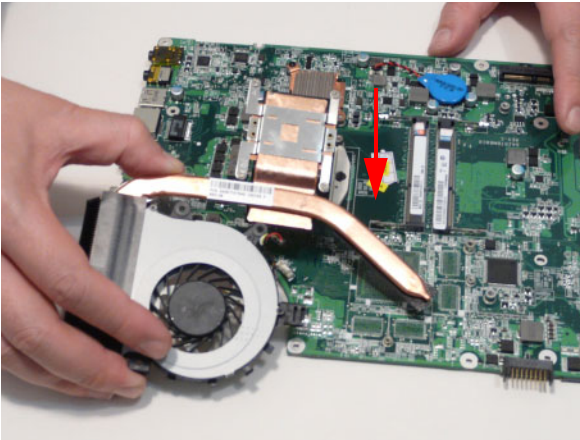

5. Connect the fan cable.

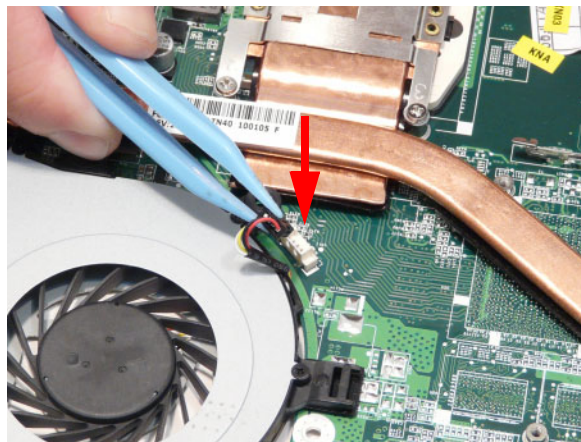

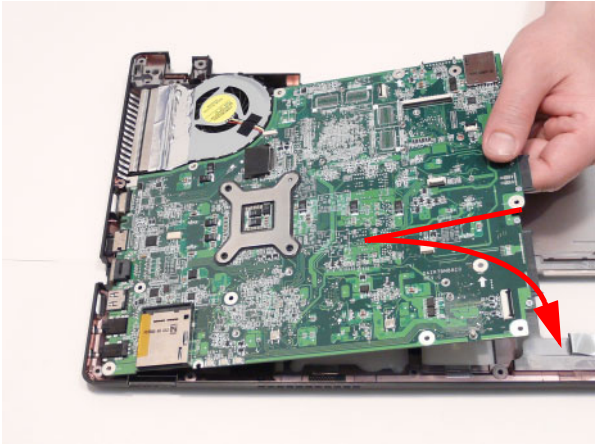

Replacing the Main Board

- 1. Slide the main board external connector edge in first to the lower case, then lower into place.

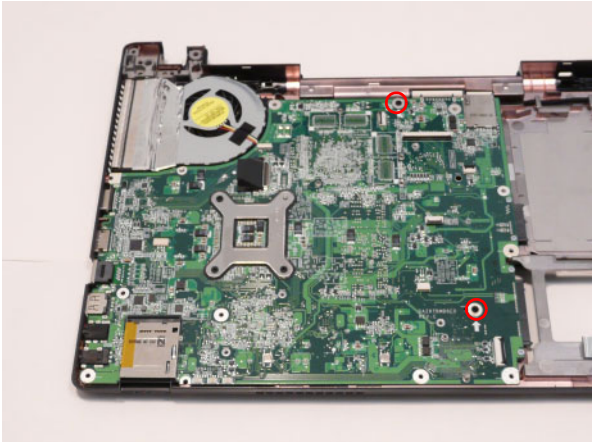

- 2. Replace the two (2) screws to secure the mainboard to the lower cover.



Step	Screw	Quantity	Screw Type
Mainboard Assembly	M2.5*5	2	

- 3. Turn the computer over and connect the power connector.



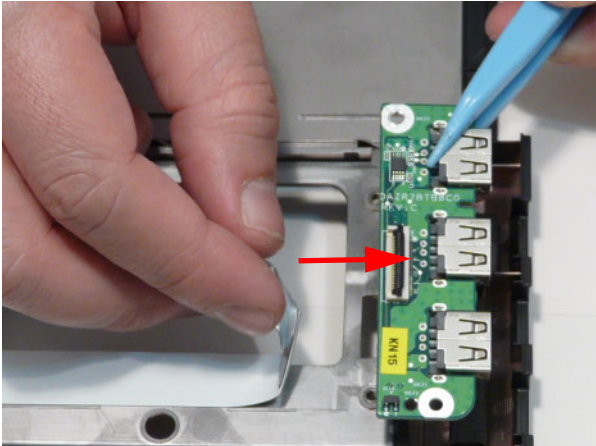

Replacing the I/O Card

1. Place the I/O card into the lower case edge first.

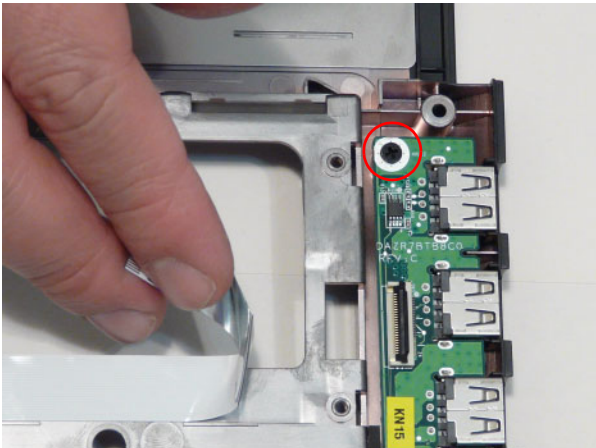

2. Replace the one (1) screw.



Step	Screw	Quantity	Screw Type
I/O Card Assembly	M2.5x5	1	

3. Connect and lock the I/O card FFC to the I/O board.

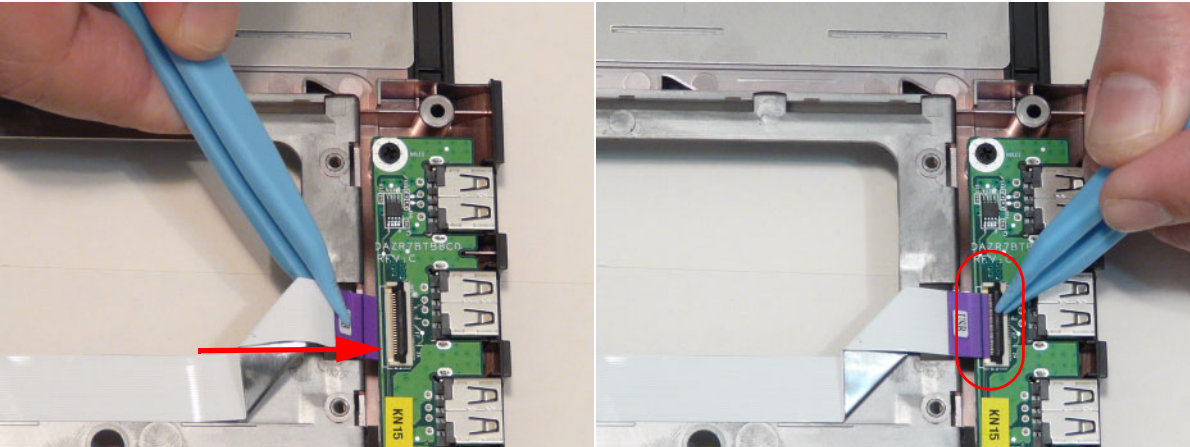

4. Connect and lock the I/O card FFC to the mainboard.

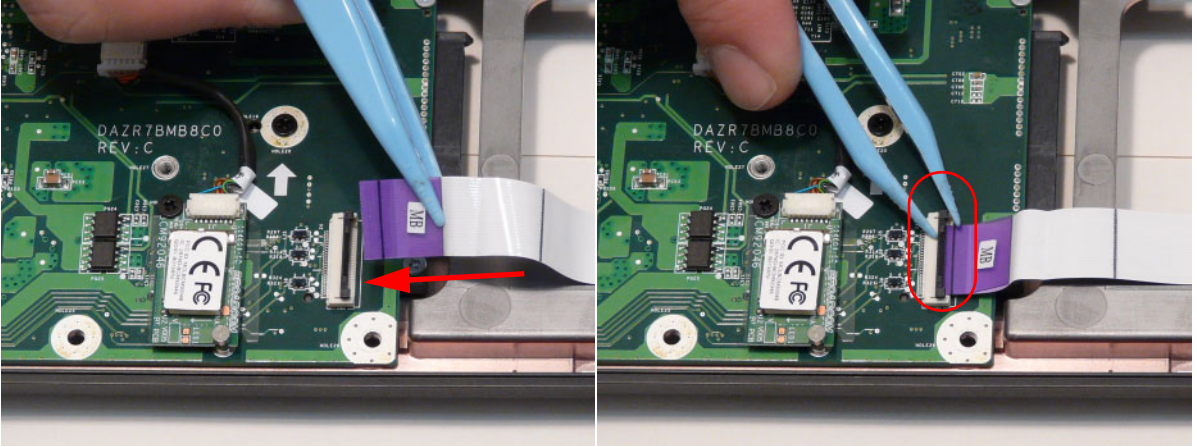

Replacing the Bluetooth Module

1. Connect the Bluetooth cable to the Bluetooth module.

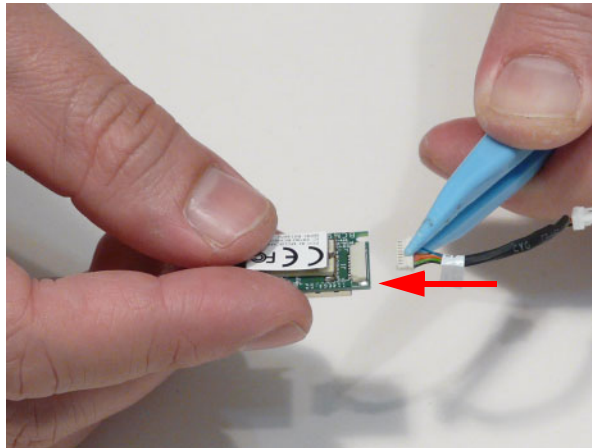

2. Place the Bluetooth module onto the mainboard pressing down firmly.

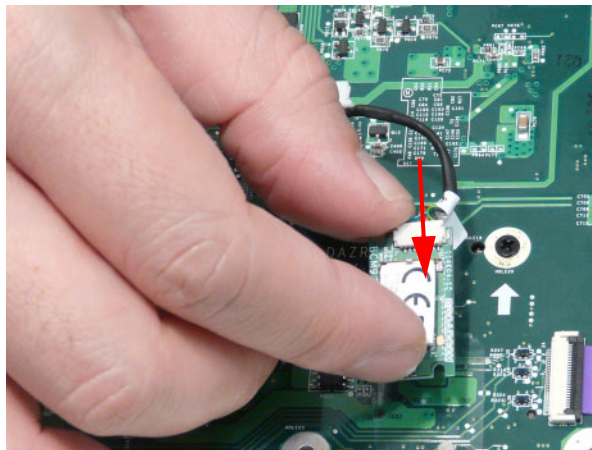

3. Replace the one (1) screw.

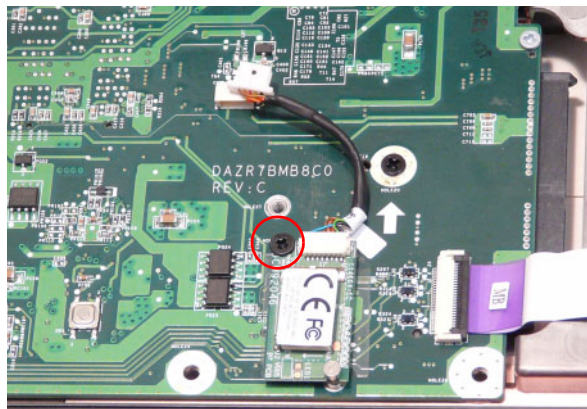

Step	Screw	Quantity	Screw Type.
Replace Bluetooth Module	M2.5*3	1	

-
4. Connect the Bluetooth module cable to the main board.

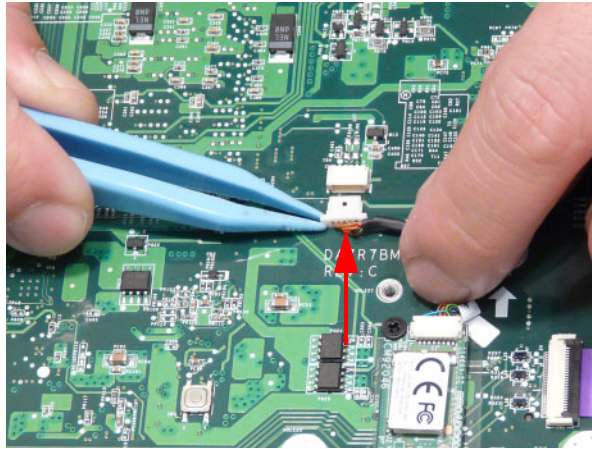

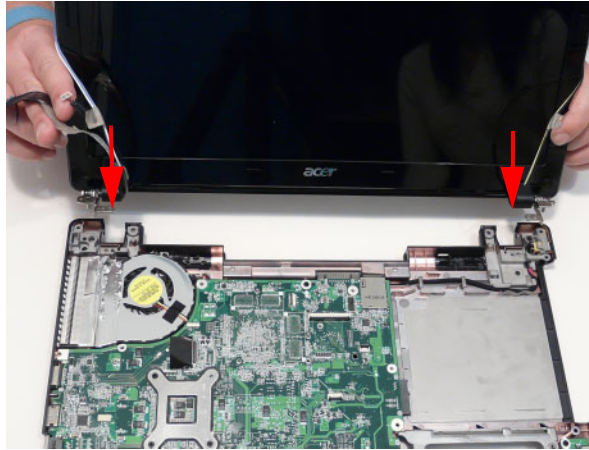

Replacing the LCD Module

1. Place the LCD module hinges into position on the lower case.

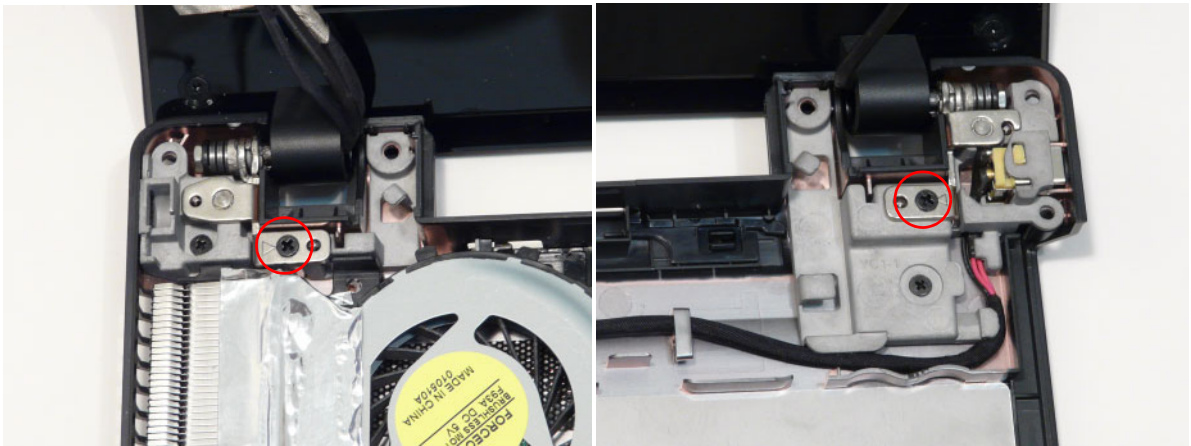

2. Replace the two (2) screws, one each in the left and right hinges.



Step	Screw	Quantity	Screw Type
LCD Module Assembly	M2.5x5	2	

3. Insert the right antenna cables through the lower cover and pull through from the other side.

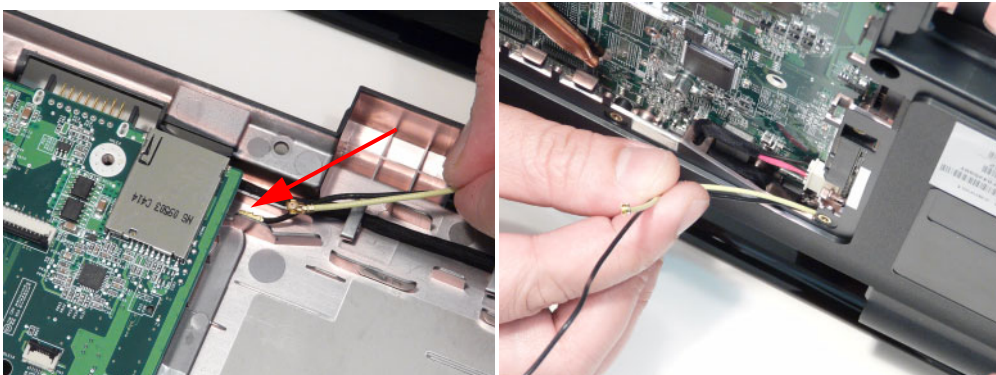

4. Lay the 3G antenna cables under the retention guides and adhere the tape.

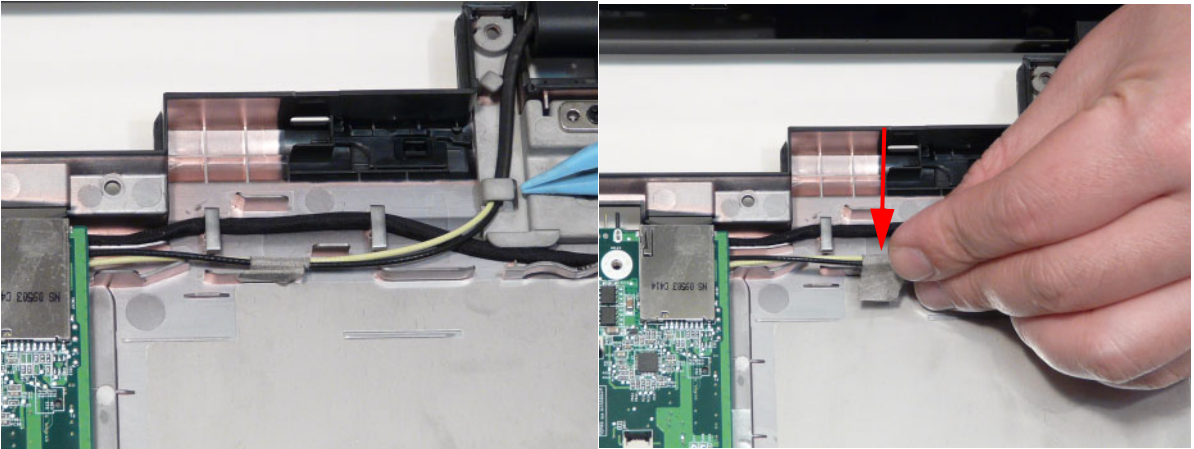

5. Push the left antenna cables through the lower cover and adhere the tape.



6. Lay the microphone cable in the location shown and press firmly to adhere the cable.

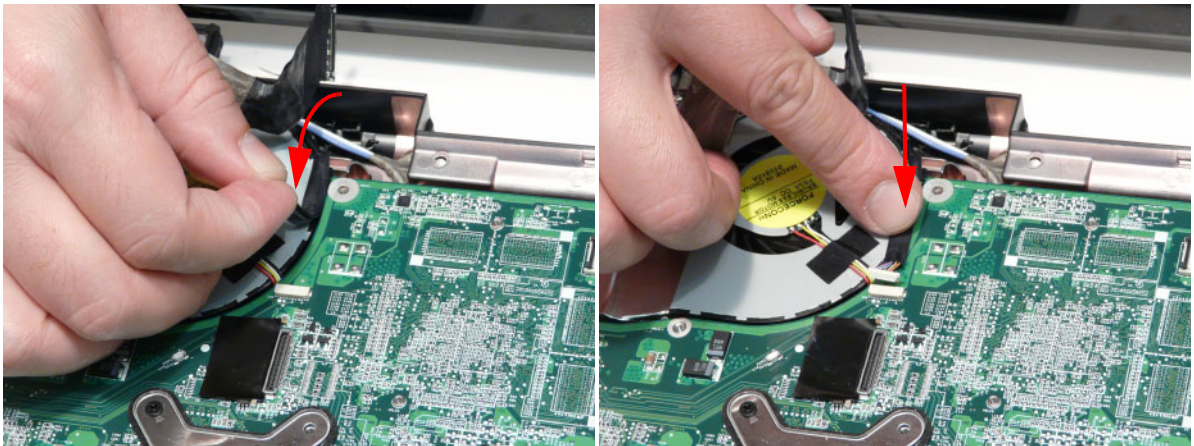

7. Connect the microphone cable.

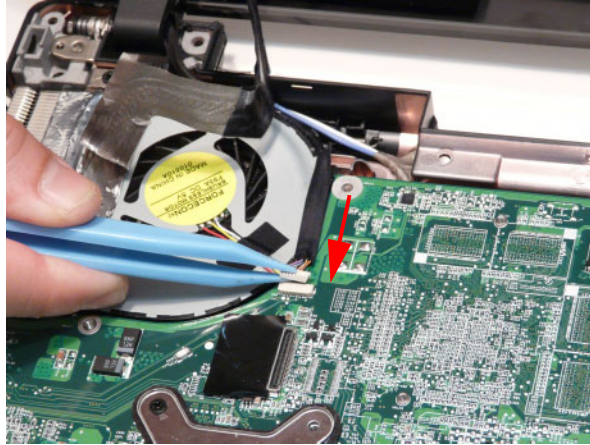

8. Lay the LVDS cable across the assembly as shown and press down firmly.

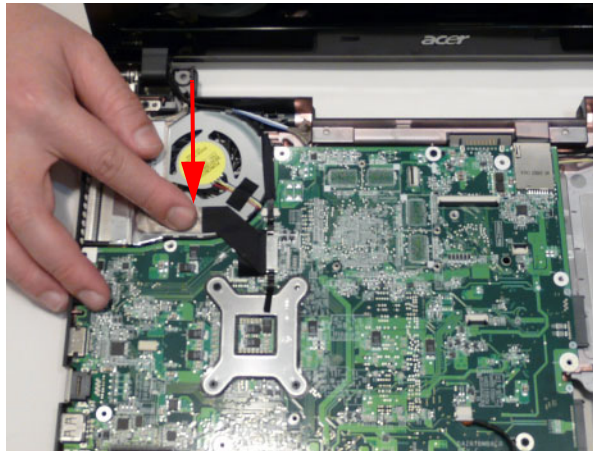

9. Connect the LVDC cable.

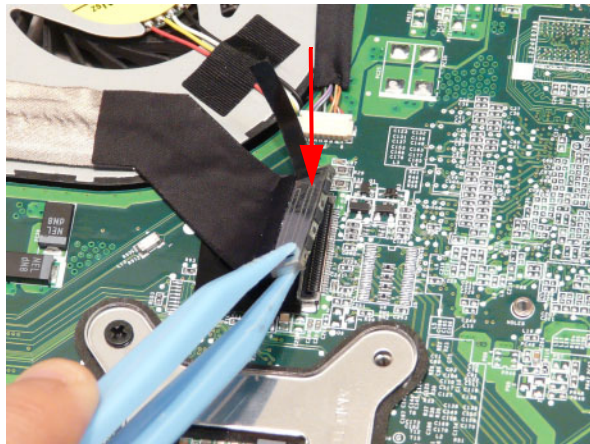

10. Press the LVDS connector left and right adhesive tabs down onto the mainboard.

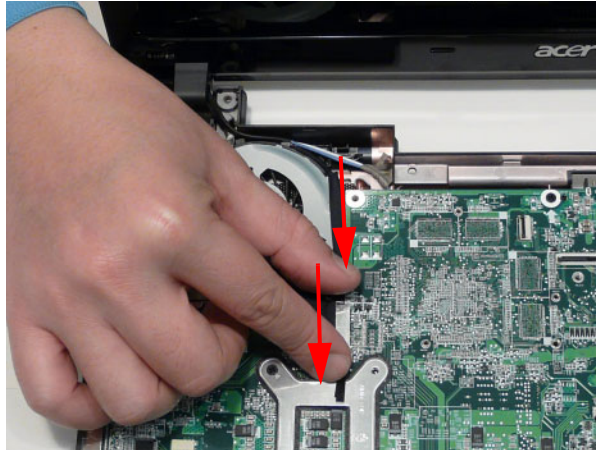

Replacing the Power Board

1. Place the power board into the upper cover.

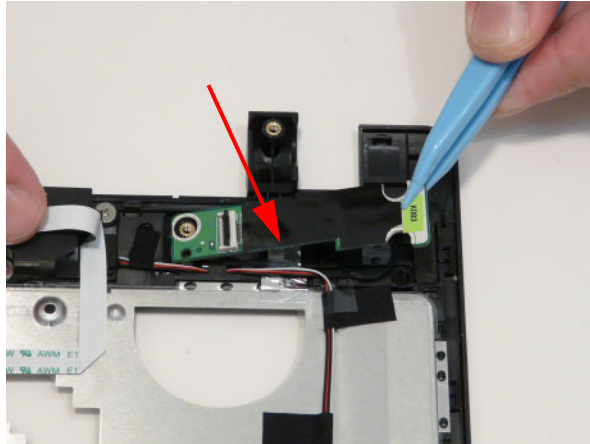

2. Replace the two (2) screws.

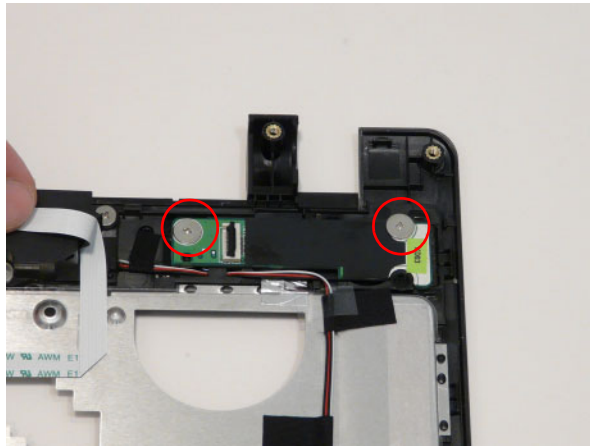

3. Connect and lock the FFC.

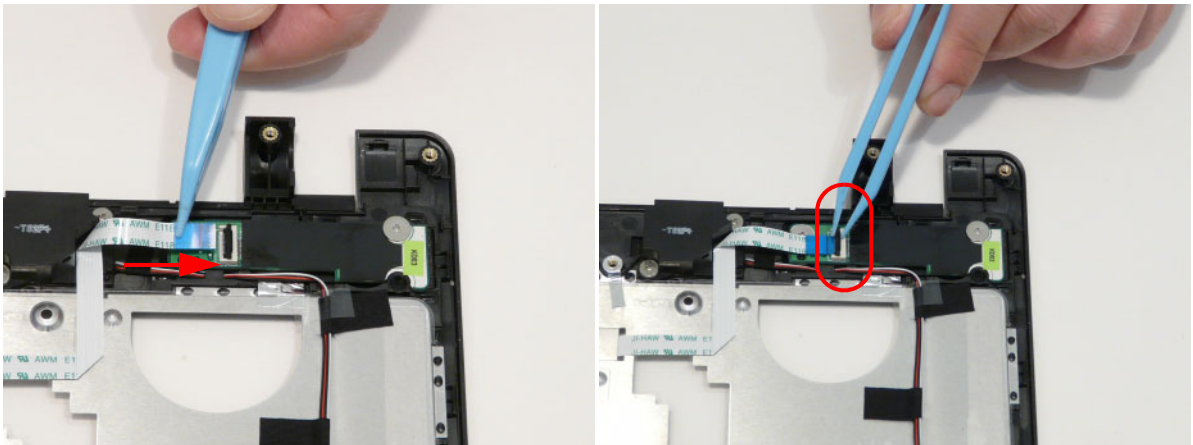

Replacing the Switch Board

1. Connect and lock the FFC.

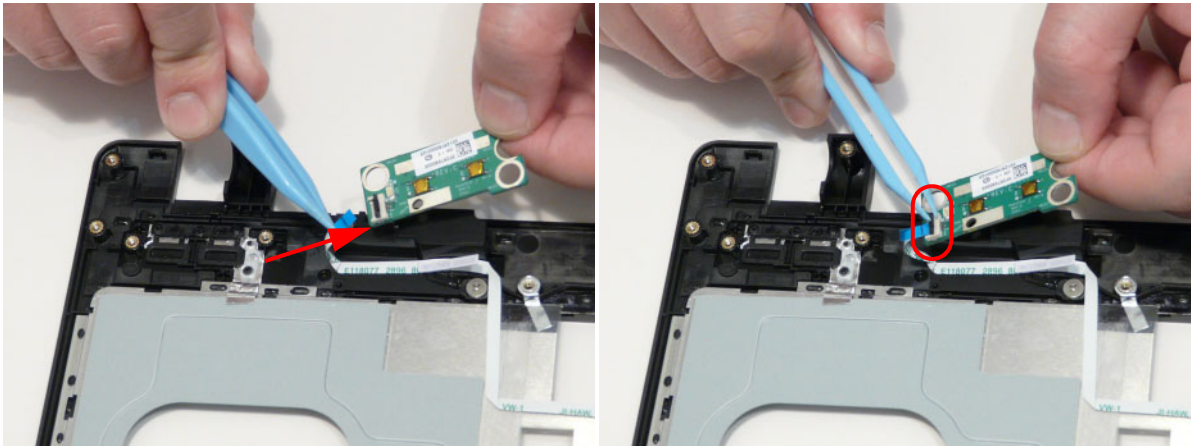

2. Turn the switch board over and place into the upper cover.

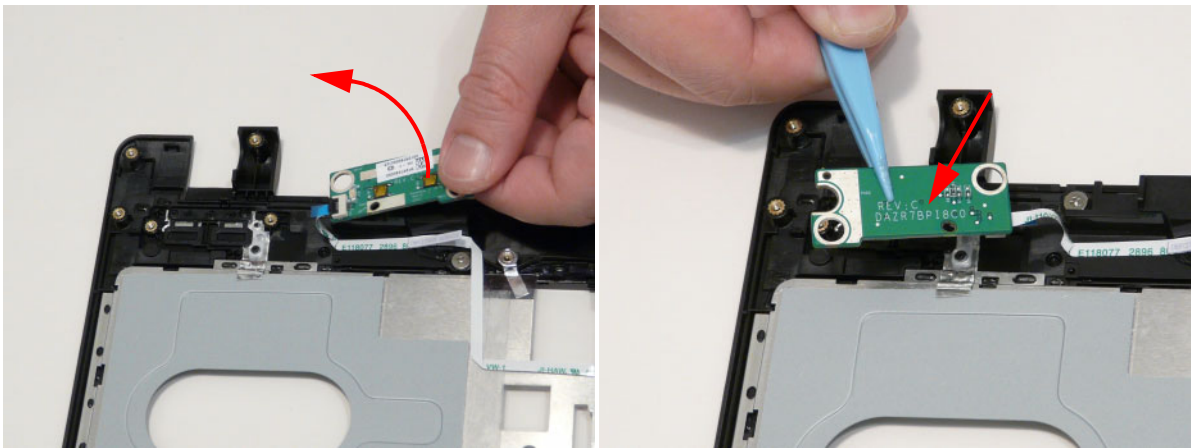

3. Replace the two (2) screws.

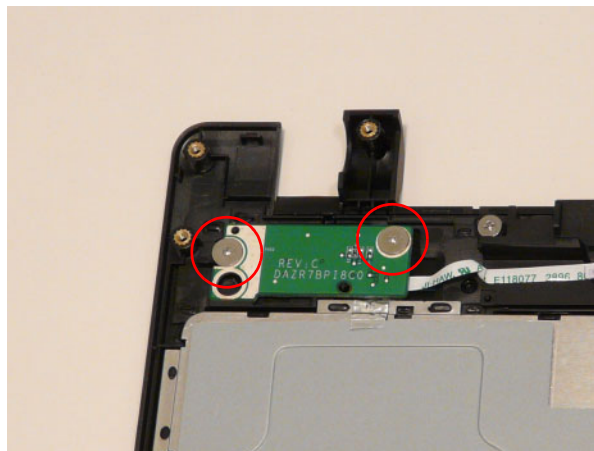

Step	Size	Quantity	Screw Type
Switch Board Assembly	T2.5*2	2	



Replacing the Upper Cover

- 1. Place the upper cover onto the lower cover aligning the hinges first and then press down around the edges.



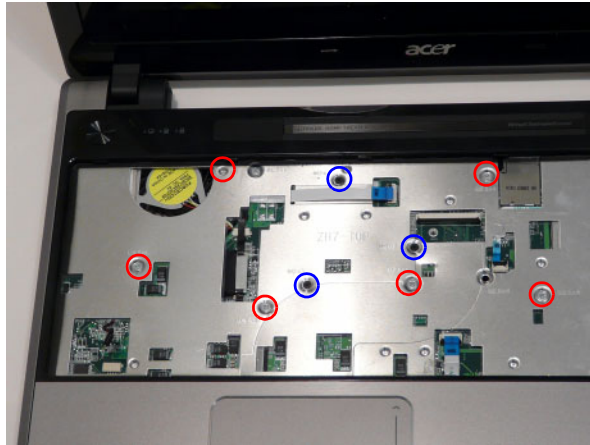

2. Replace the nine (9) screws.

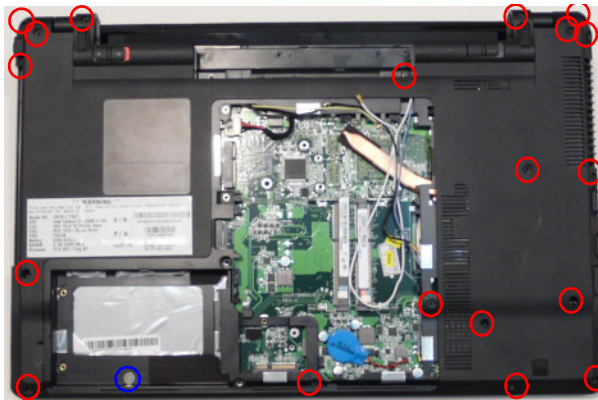

Step	Size	Quantity	Screw Type
Upper Cover Assembly	M2*3	3 (blue call out)	
	M2*5 Ni	6 (red call out)	

3. Turn the computer over and replace the bottom cover twenty (20) screws.



Step	Size	Quantity	Screw Type
Lower Cover Assembly	M2.5*5	19 (red call out)	
	T2.5*2	1 (blue call out)	

4. Connect the speaker cable.

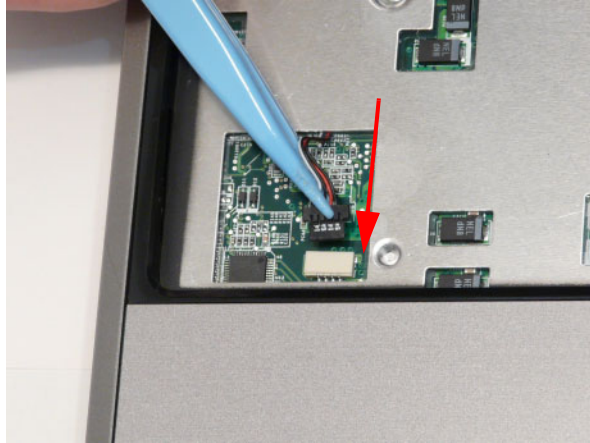

5. Connect and lock the switch board FFC.

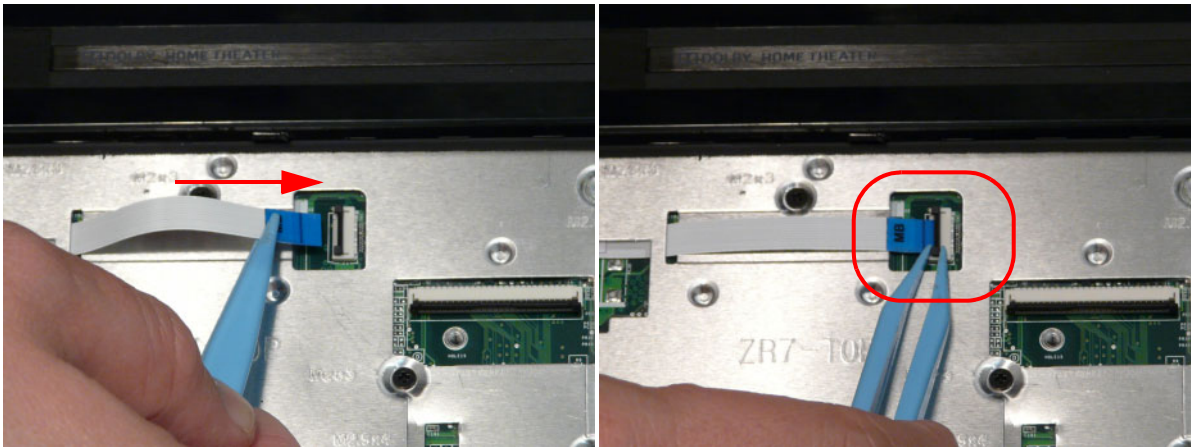

6. Connect and lock the power board FFC.

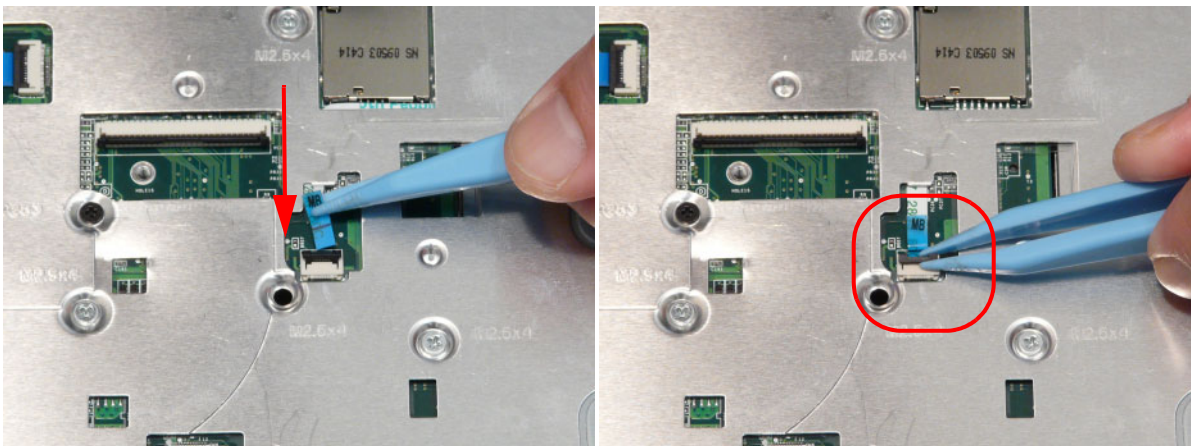

7. Connect and lock the button board FFC.

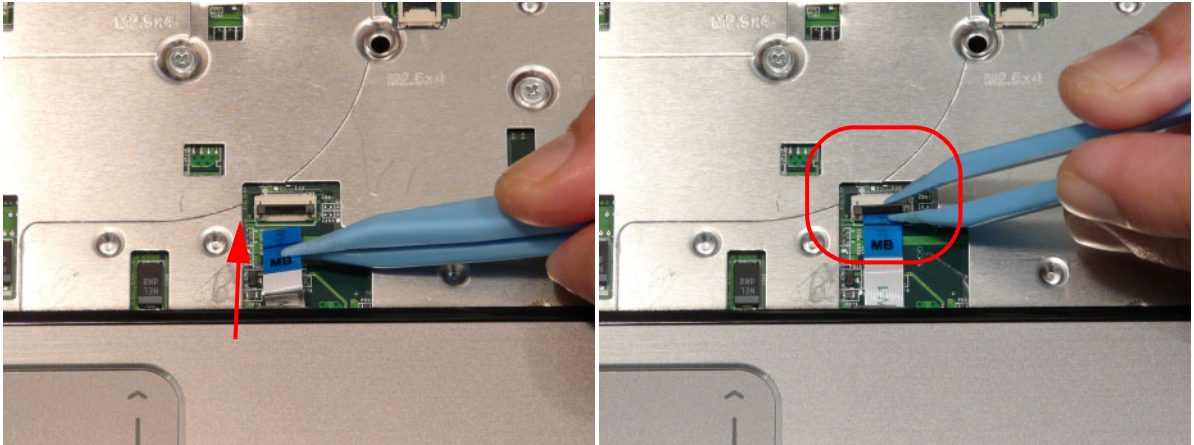

Replacing the Keyboard

1. Connect the FFC to the mainboard.

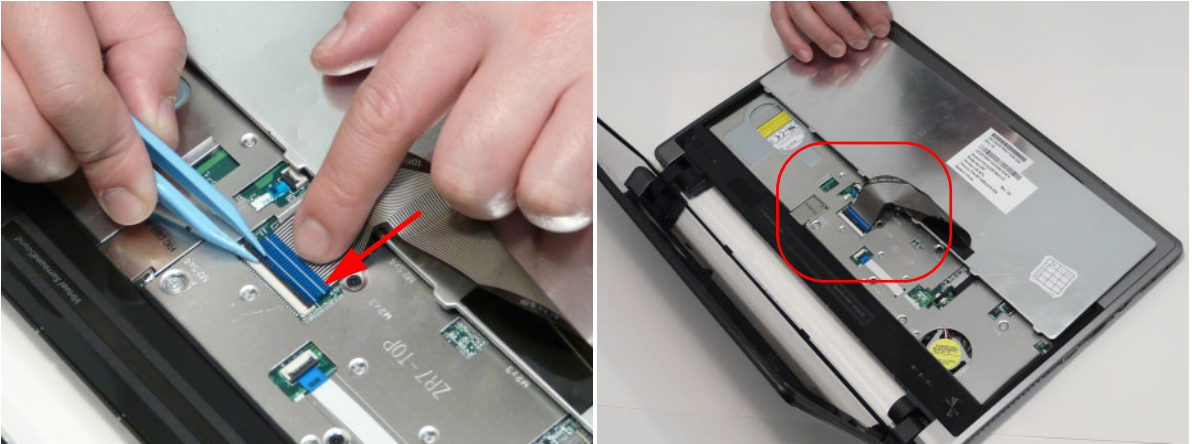

2. Turn the keyboard over and insert the bottom edge in first, then push to down ensure the five latches across the top are fully secured.



Replacing the Wireless LAN Module

1. Lay the white wireless LAN antenna cable into the retention guides.

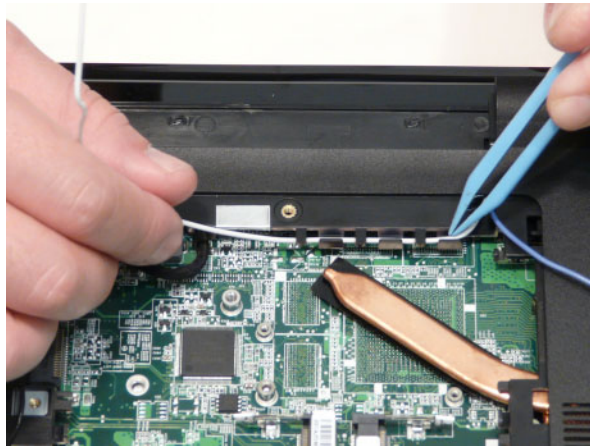

2. Lay the white and black wireless LAN antenna cables into the retention guides.

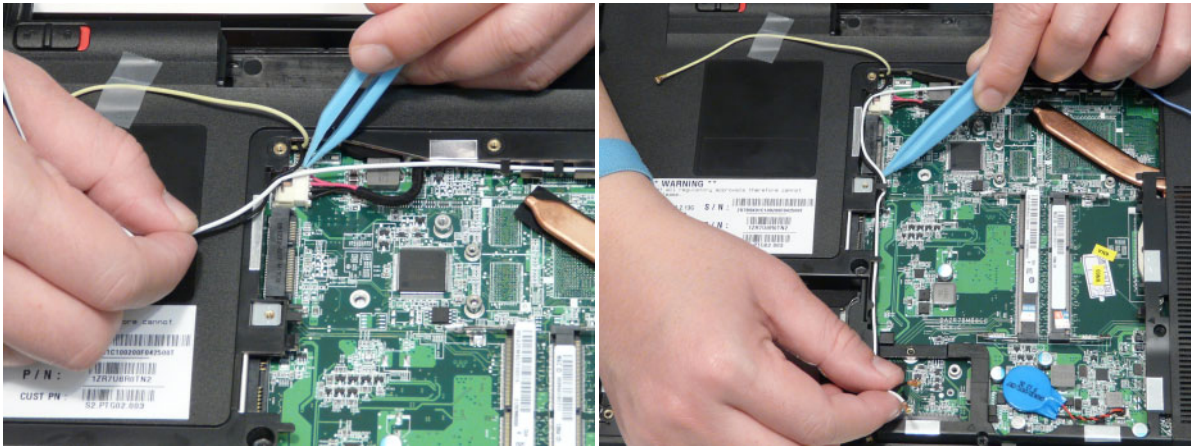

3. Insert the wireless LAN module into the connector.

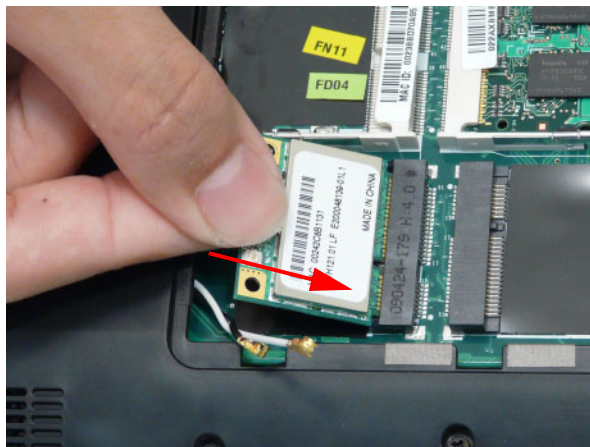

- Replace the one screw.



Step	Size	Quantity	Screw Type
WLAN Assembly	M2.5*3	1	

- Replace the connectors. The white (Aux) cable attaches to the connector marked **2** on the board. The black (Main) cable attaches to the connector marked **1** on the board.

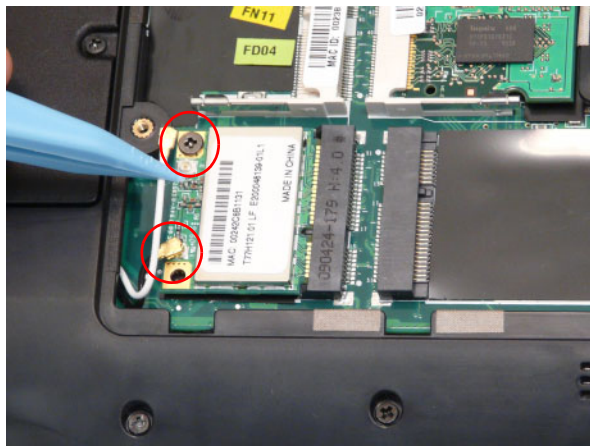

Replacing the 3G Module.

1. Lay the 3G module cables into the retention guides.



2. Replace the 3G module.

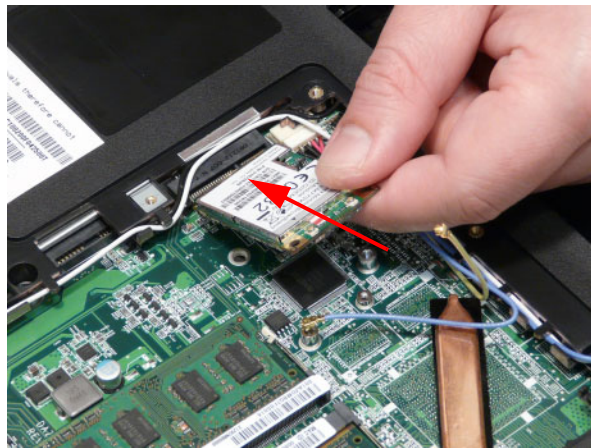

3. Replace the one screw.



Step	Size	Quantity	Screw Type
3G Module Assembly	M2.5*3	1	

-
4. Replace the connectors. The blue (Aux) cable attaches to the connector marked **A** on the board. The yellow (Main) cable attaches to the connector marked **M** on the board.



Replacing the DIMM Module

1. Slide the DIMM module into the connector.

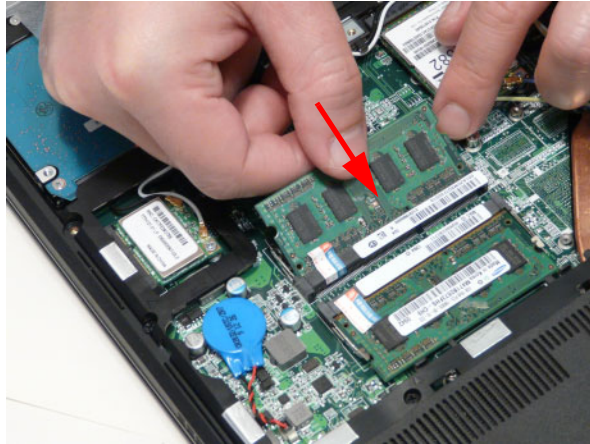

2. Press down till the locking springs click into place.



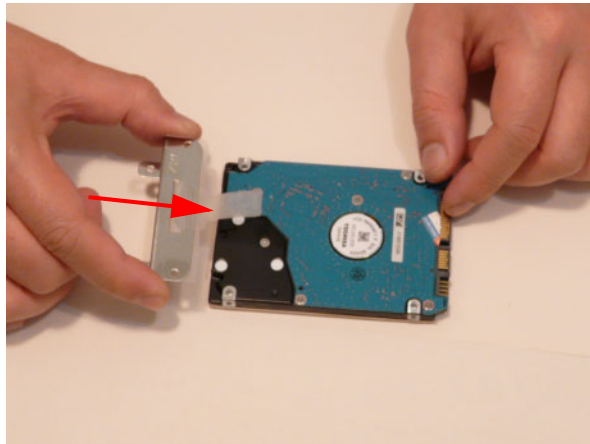

Replacing the Hard Disk Drive

1. Place the HDD bracket onto the HDD.

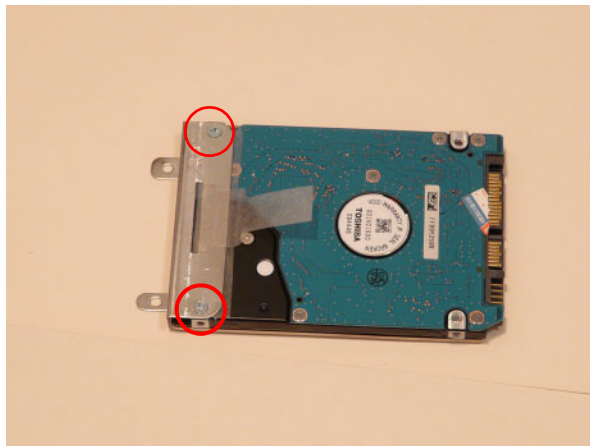

2. Replace the two (2) screws.



Step	Size	Quantity	Screw Type
HDD Assembly	M3*3	2	

3. Insert the HDD into the bay inserting the bracket flanges into the lower cover slots first.

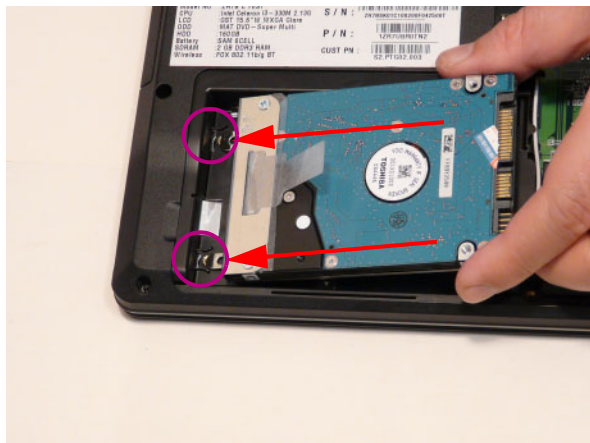

-
4. Grasp the tab and slide the HDD firmly into the docking connector.

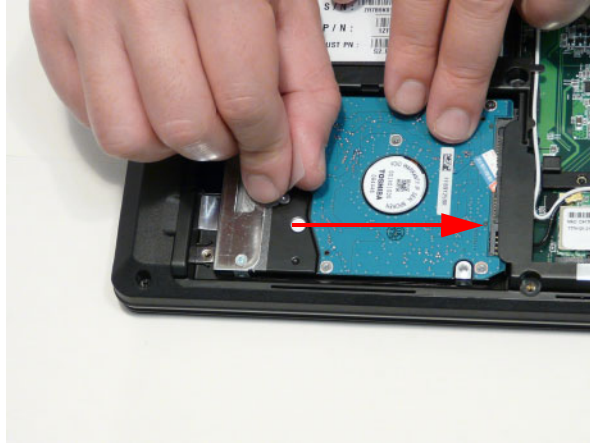

Replacing the RTC Battery

1. Place the RTC battery onto the mainboard and press down firmly.



2. Connect the RTC battery cable to the mainboard.



Replacing the ODD Module

- 1. Replace the ODD bezel.



- 2. Replace the ODD bracket.

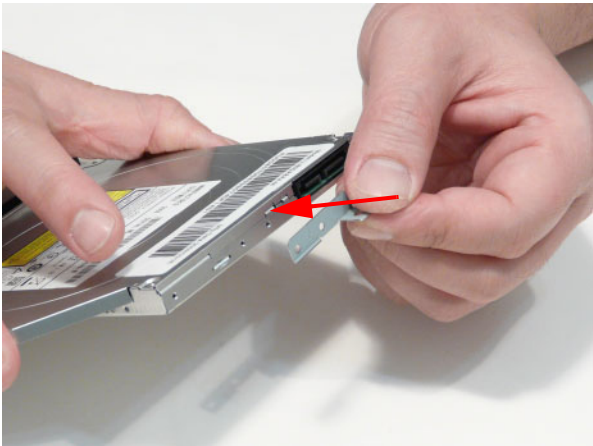

- 3. Replace the two (2) screws of the ODD bracket.



Step	Screw	Quantity	Screw Type
ODD Module Disassembly	M2*3Ni	2	

-
4. Push the ODD completely into the bay until flush with the lower cover.



Replacing the Base Door

1. Insert the base door edge flanges into the slots.

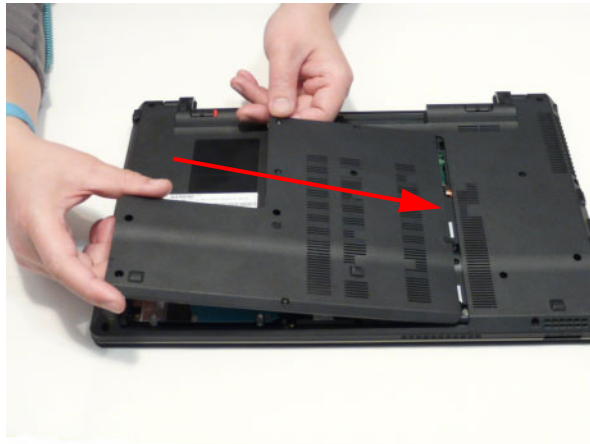

2. Lower the base door.



3. Replace the eight (8) screws.

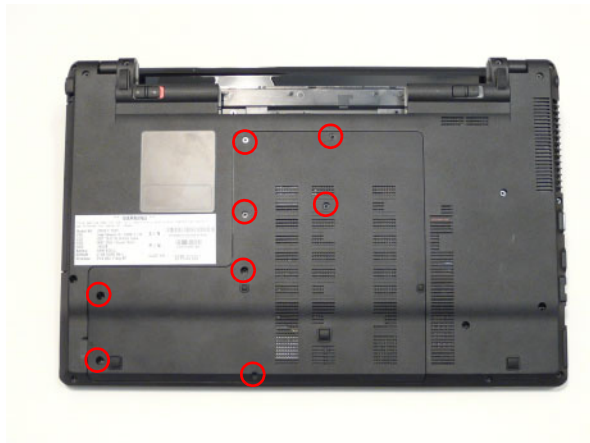

Step	Size	Quantity	Screw Type
Base Door Assembly	M2.5*8	8	

Replacing the SIM Card

1. Insert the SIM card in till it clicks into place.



Replacing the Battery

1. Slide the battery into position.

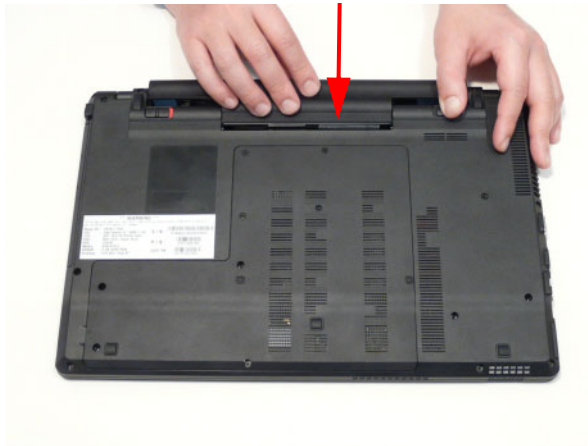

2. Close the locking latch.



Replace the Dummy Card

Push the dummy card into the slot until it clicks into place.



Troubleshooting

Common Problems

Use the following procedure as a guide for computer problems.

NOTE: The diagnostic tests are intended to test only Acer products. Non-Acer products, prototype cards, or modified options can give false errors and invalid system responses.

1. Obtain the failing symptoms in as much detail as possible.
2. Verify the symptoms by attempting to re-create the failure by running the diagnostic test or by repeating the same operation.
3. Use the following table with the verified symptom to determine which page to go to.

Symptoms (Verified)	Go To
Power On Issue	Page 146
No Display Issue	Page 147
LCD Failure	Page 149
Internal Keyboard Failure	Page 150
TouchPad Failure	Page 151
Internal Speaker Failure	Page 152
Internal Microphone Failure	Page 153
USB Failure	Page 155
Other Function Failure	Page 155

4. If the Issue is still not resolved, see "Online Support Information" on page 255.

Power On Issue

If the system doesn't power on, perform the following actions one at a time to correct the problem. Do not replace non-defective FRUs:

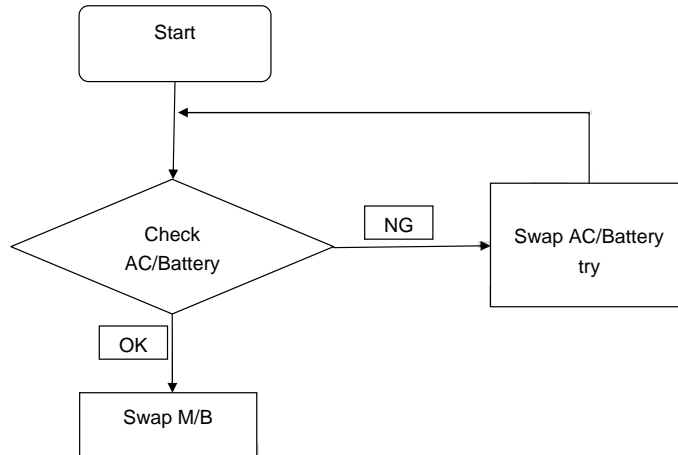

Computer Shuts down Intermittently

If the system powers off at intervals, perform the following actions one at a time to correct the problem.

1. Check the power cable is properly connected to the computer and the electrical outlet.
2. Remove any extension cables between the computer and the outlet.
3. Remove any surge protectors between the computer and the electrical outlet. Plug the computer directly into a known good electrical outlet.
4. Remove all external and non-essential hardware connected to the computer that are not necessary to boot the computer to the failure point.
5. Remove any recently installed software.
6. If the Issue is still not resolved, see "Online Support Information" on page 255.

No Display Issue

If the **Display** doesn't work, perform the following actions one at a time to correct the problem. Do not replace non-defective FRUs:

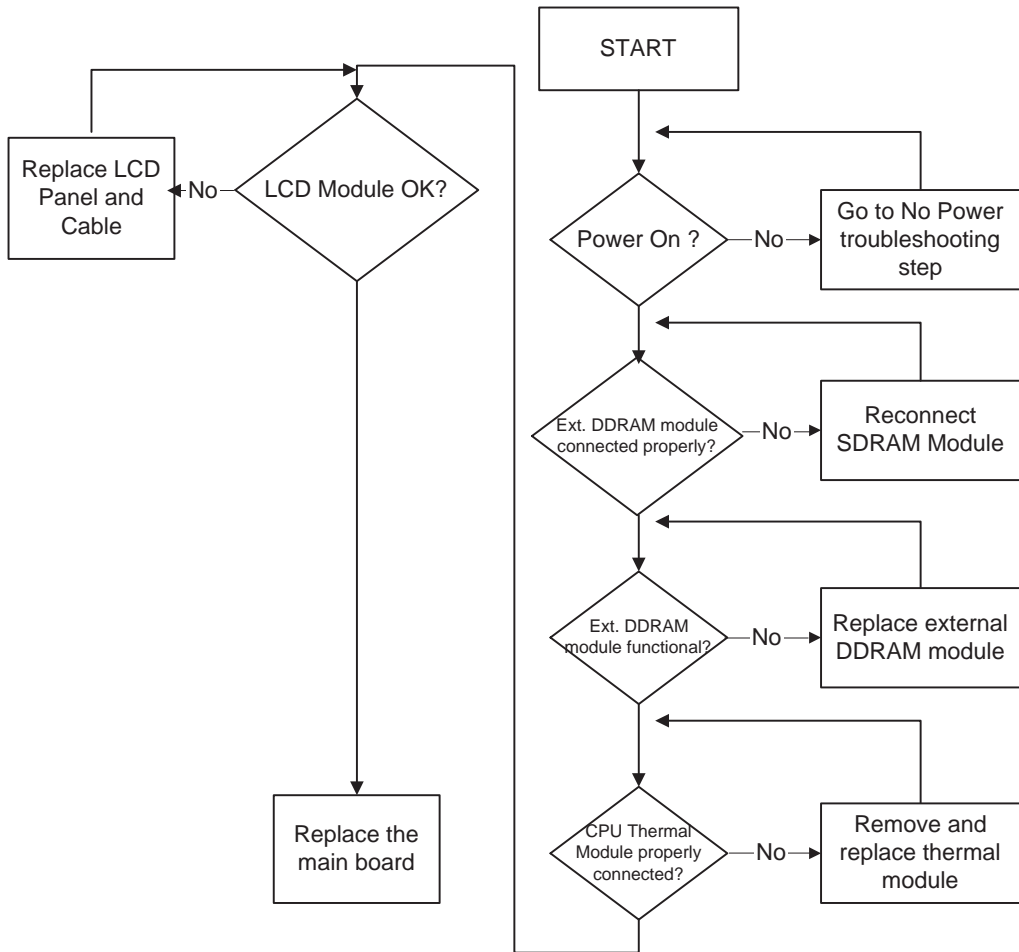

No POST or Video

If the POST or video doesn't display, perform the following actions one at a time to correct the problem.

1. Make sure that the internal display is selected. On this notebook model, switching between the internal display and the external display is done by pressing **Fn+F5**. Reference Product pages for specific model procedures.
2. Make sure the computer has power by checking at least one of the following occurs:
 - Fans start up
 - Status LEDs light up

If there is no power, see "Power On Issue" on page 146.

3. Drain any stored power by removing the power cable and battery and holding down the power button for 10 seconds. Reconnect the power and reboot the computer.
4. Connect an external monitor to the computer and switch between the internal display and the external display is by pressing **Fn+F5** (on this model).

If the POST or video appears on the external display, see "LCD Failure" on page 149.

5. Disconnect power and all external devices including port replicators or docking stations. Remove any memory cards and CD/DVD discs. Restart the computer.

If the computer boots correctly, add the devices one by one until the failure point is discovered.

6. Reseat the memory modules.
7. Remove the drives (see “Disassembly Process” on page 41).
8. If the Issue is still not resolved, see “Online Support Information” on page 255.

Abnormal Video Display

If video displays abnormally, perform the following actions one at a time to correct the problem.

1. Reboot the computer.
2. If permanent vertical/horizontal lines or dark spots display in the same location, the LCD is faulty and should be replaced. See “Disassembly Process” on page 41.
3. If extensive pixel damage is present (different colored spots in the same locations on the screen), the LCD is faulty and should be replaced. See “Disassembly Process” on page 41.
4. Adjust the brightness to its highest level. See the User Manual for instructions on adjusting settings.
NOTE: Ensure that the computer is not running on battery alone as this may reduce display brightness.

If the display is too dim at the highest brightness setting, the LCD is faulty and should be replaced. See “Disassembly Process” on page 41.

5. Check the display resolution is correctly configured:
 - a. Minimize or close all Windows.
 - b. If display size is only abnormal in an application, check the view settings and control/mouse wheel zoom feature in the application.
 - c. If desktop display resolution is not normal, right-click on the desktop and select **Personalize**→ **Display Settings**.
 - d. Click and drag the Resolution slider to the desired resolution.
 - e. Click **Apply** and check the display. Readjust if necessary.
6. Roll back the video driver to the previous version if updated.
7. Remove and reinstall the video driver.
8. Check the Device Manager to determine that:
 - The device is properly installed. There are no red Xs or yellow exclamation marks.
 - There are no device conflicts.
 - No hardware is listed under Other Devices.
9. If the Issue is still not resolved, see “Online Support Information” on page 255.
10. Run the Windows Memory Diagnostic from the operating system DVD and follow the onscreen prompts.
11. If the Issue is still not resolved, see “Online Support Information” on page 255.

Random Loss of BIOS Settings

If the computer is experiencing intermittent loss of BIOS information, perform the following actions one at a time to correct the problem.

1. If the computer is more than one year old, replace the CMOS battery.
2. Run a complete virus scan using up-to-date software to ensure the computer is virus free.
3. If the computer is experiencing HDD or ODD BIOS information loss, disconnect and reconnect the power and data cables between devices.
If the BIOS settings are still lost, replace the cables.
4. If HDD information is missing from the BIOS, the drive may be defective and should be replaced.
5. Replace the Motherboard.

6. If the Issue is still not resolved, see “Online Support Information” on page 255.

LCD Failure

If the **LCD** fails, perform the following actions one at a time to correct the problem. Do not replace non-defective FRUs:

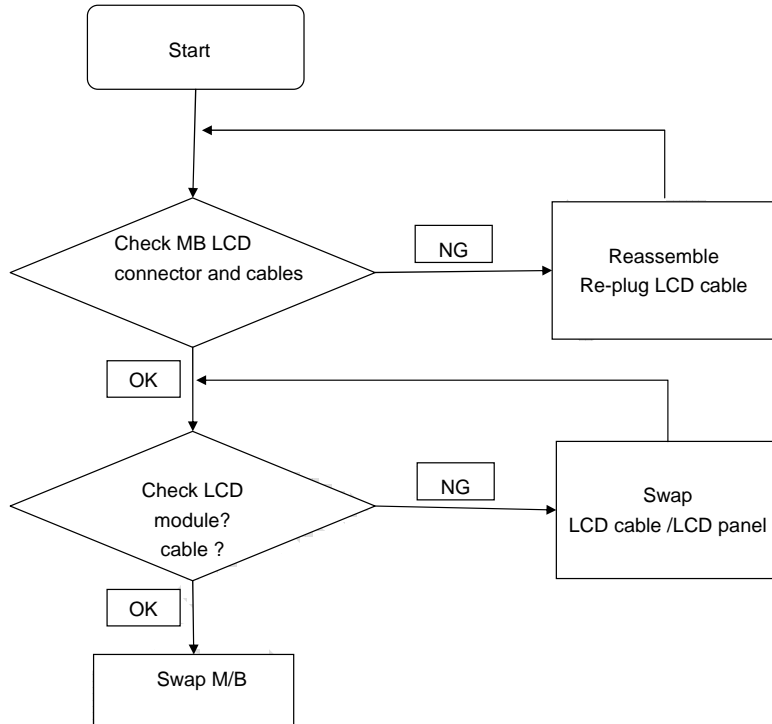

Built-In Keyboard Failure

If the built-in **Keyboard** fails, perform the following actions one at a time to correct the problem. Do not replace non-defective FRUs:

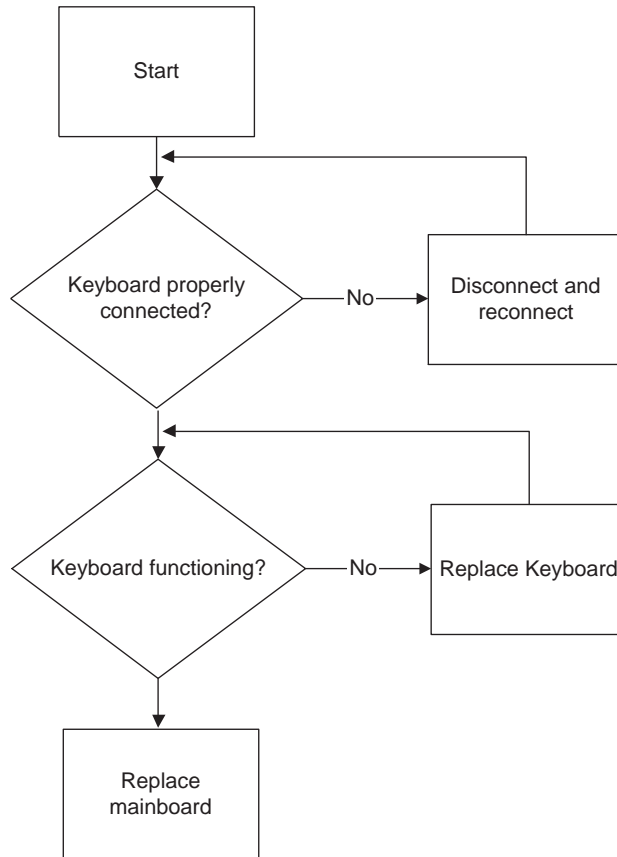

TouchPad Failure

If the **TouchPad** doesn't work, perform the following actions one at a time to correct the problem. Do not replace non-defective FRUs:

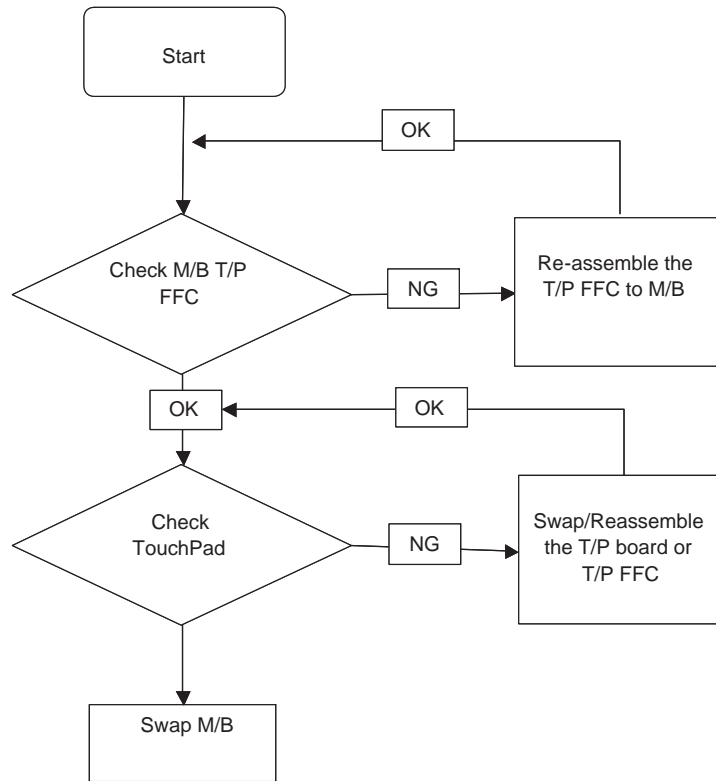

Internal Speaker Failure

If the internal **Speakers** fail, perform the following actions one at a time to correct the problem. Do not replace non-defective FRUs:

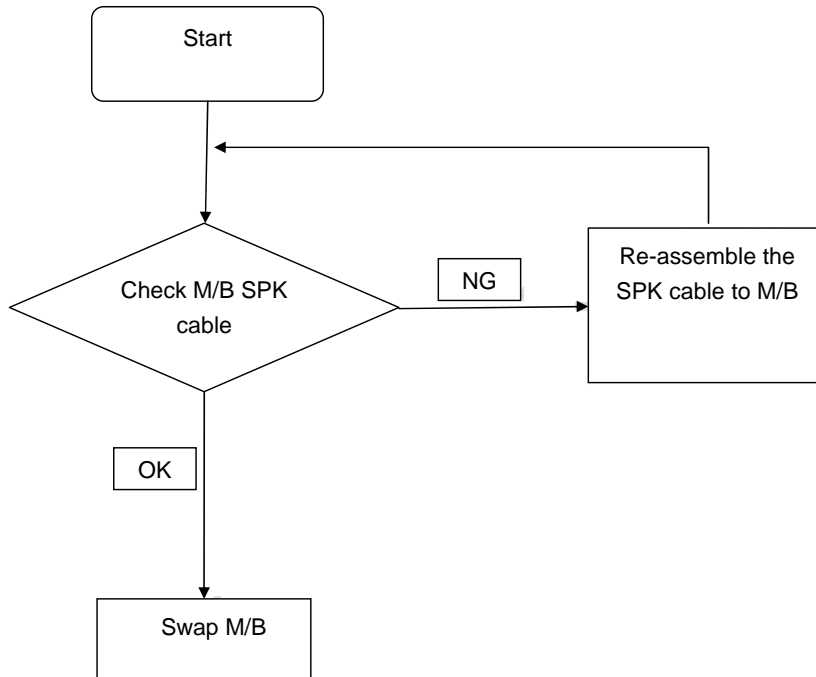

Sound Problems

If sound problems are experienced, perform the following actions one at a time to correct the problem.

1. Reboot the computer.
2. Navigate to **Start** → **Control Panel** → **System and Maintenance** → **System** → **Device Manager**. Check the Device Manager to determine that:
 - The device is properly installed.
 - There are no red Xs or yellow exclamation marks.
 - There are no device conflicts.
 - No hardware is listed under Other Devices.
3. Roll back the audio driver to the previous version, if updated recently.
4. Remove and reinstall the audio driver.
5. Ensure that all volume controls are set mid range:
 - a. Click the volume icon on the taskbar and drag the slider to 50. Ensure that the volume is not muted.
 - b. Click Mixer to verify that other audio applications are set to 50 and not muted.
6. Navigate to **Start** → **Control Panel** → **Hardware and Sound** → **Sound**. Ensure that Speakers are selected as the default audio device (green check mark).

NOTE: If Speakers does not show, right-click on the **Playback** tab and select **Show Disabled Devices** (clear by default).
7. Select Speakers and click **Configure** to start **Speaker Setup**. Follow the onscreen prompts to configure the speakers.
8. Remove and recently installed hardware or software.

9. Restore system and file settings from a known good date using **System Restore**.
If the issue is not fixed, repeat the preceding steps and select an earlier time and date.
10. Reinstall the Operating System.
11. If the Issue is still not resolved, see “Online Support Information” on page 255.

Internal Microphone Failure

If the internal **Microphone** fails, perform the following actions one at a time to correct the problem. Do not replace non-defective FRUs:

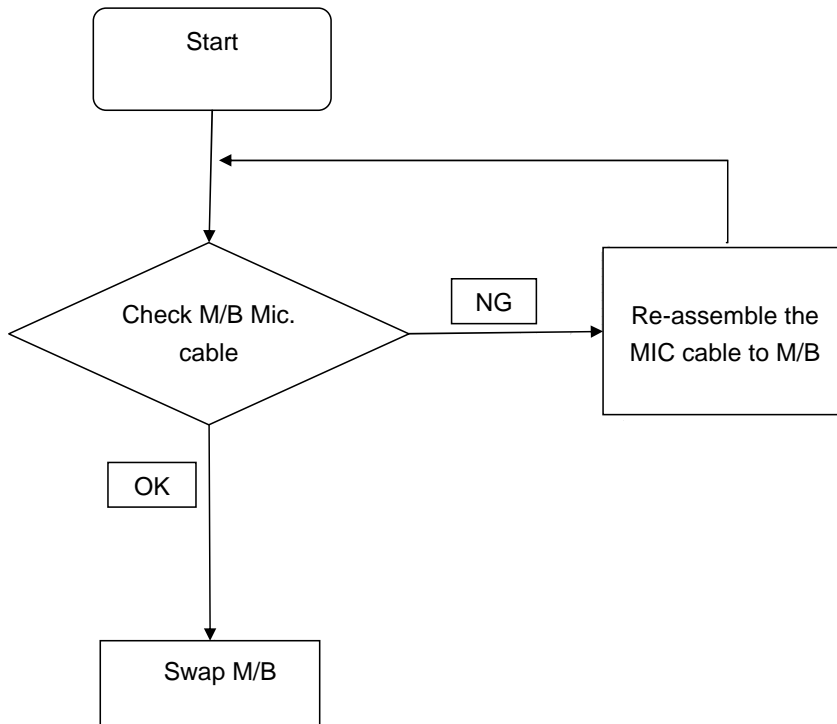

Microphone Problems

If internal or external **Microphones** do not operate correctly, perform the following actions one at a time to correct the problem.

1. Check that the microphone is enabled. Navigate to **Start** → **Control Panel** → **Hardware and Sound** → **Sound** and select the **Recording** tab.
2. Right-click on the **Recording** tab and select **Show Disabled Devices** (clear by default).
3. The microphone appears on the **Recording** tab.
4. Right-click on the microphone and select **Enable**.
5. Select the microphone then click **Properties**. Select the **Levels** tab.
6. Increase the volume to the maximum setting and click **OK**.
7. Test the microphone hardware:
 - a. Select the microphone and click **Configure**.
 - b. Select **Set up microphone**.
 - c. Select the microphone type from the list and click **Next**.
 - d. Follow the onscreen prompts to complete the test.

-
8. If the Issue is still not resolved, see “Online Support Information” on page 255.

HDD Not Operating Correctly

If the **HDD** does not operate correctly, perform the following actions one at a time to correct the problem.

1. Disconnect all external devices.
2. Run a complete virus scan using up-to-date software to ensure the computer is virus free.
3. Run the Windows 7 Startup Repair Utility:
 - a. insert the Windows 7 Operating System DVD in the ODD and restart the computer.
 - b. When prompted, press any key to start to the operating system DVD.
 - c. The **Install Windows** screen displays. Click **Next**.
 - d. Select **Repair your computer**.
 - e. The **System Recovery Options** screen displays. Click **Next**.
 - f. Select the appropriate operating system, and click **Next**.

NOTE: Click **Load Drivers** if controller drives are required.

- g. Select **Startup Repair**.
- h. Startup Repair attempts to locate and resolve issues with the computer.
- i. When complete, click **Finish**.

If an issue is discovered, follow the onscreen information to resolve the problem.

4. Run the Windows Memory Diagnostic Tool. For more information see Windows Help and Support.
5. Restart the computer and press F2 to enter the BIOS Utility. Check the BIOS settings are correct and that CD/DVD drive is set as the first boot device on the Boot menu.
6. Ensure all cables and jumpers on the HDD and ODD are set correctly.
7. Remove any recently added hardware and associated software.
8. Run the Windows Disk Defragmenter. For more information see Windows Help and Support.
9. Run Windows Check Disk by entering **chkdsk /r** from a command prompt. For more information see Windows Help and Support.
10. Restore system and file settings from a known good date using **System Restore**.
If the issue is not fixed, repeat the preceding steps and select an earlier time and date.
11. Replace the HDD. See “Disassembly Process” on page 41.

USB Failure (Right up/down side)

If the rightside **USB** port fails, perform the following actions one at a time to correct the problem. Do not replace non-defective FRUs:

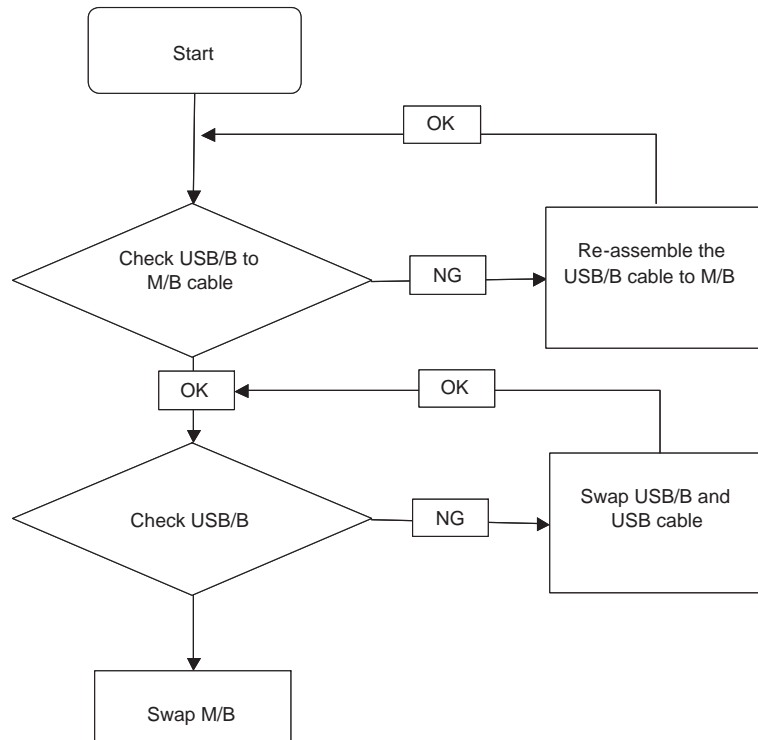

Other Failures

If the VGA board, LAN Port, external MIC or Speakers, PCI Express Card, 5-in-1 Card Reader or Volume Wheel fail, perform the following general steps to correct the problem. Do not replace non-defective FRUs:

1. Check whether the drive is OK.
2. Verify that the Test Fixture is OK.
3. Swap the mainboard and retest.

Intermittent Problems

Intermittent system hang problems can be caused by a variety of reasons that have nothing to do with a hardware defect, such as: cosmic radiation, electrostatic discharge, or software errors. FRU replacement should be considered only when a recurring problem exists.

When analyzing an intermittent problem, do the following:

1. Run the advanced diagnostic test for the system board in loop mode at least 10 times.
2. If no error is detected, do not replace any FRU.
3. If any error is detected, replace the FRU. Rerun the test to verify that there are no more errors.

Undetermined Problems

The diagnostic problems does not identify which adapter or device failed, which installed devices are incorrect, whether a short circuit is suspected, or whether the system is inoperative.

Follow these procedures to isolate the failing FRU (do not isolate non-defective FRU).

NOTE: Verify that all attached devices are supported by the computer.

NOTE: Verify that the power supply being used at the time of the failure is operating correctly. (See “Power On Issue” on page 146.):

1. Power-off the computer.
2. Visually check them for damage. If any problems are found, replace the FRU.
3. Remove or disconnect all of the following devices:
 - Non-Acer devices
 - Printer, mouse, and other external devices
 - Battery pack
 - Hard disk drive
 - DIMM
 - CD-ROM/Diskette drive Module
 - PC Cards
4. Power-on the computer.
5. Determine if the problem has changed.
6. If the problem does not recur, reconnect the removed devices one at a time until you find the failing FRU.
7. If the problem remains, replace the following FRU one at a time. Do not replace a non-defective FRU:
 - System board
 - LCD assembly

Post Code Reference Tables

These tables describe the POST codes and descriptions during the POST.

Post Code Range

Phase	POST Code Range
SEC	0x01 - 0x0F
PEI	0x70 - 0x9F
DXE	0x40 - 0x6F
BDS	0x10 - 0x3F
SMM	0xA0 - 0xBF
S3	0xC0 - 0xCF
ASL	0x51 – 0x55
	0xE1 – 0xE4
PostBDS	0xF9 – 0xFE
InsydeH2ODDT™ Reserve	0xD0 – 0xD7
OEM Reserve	0xE8 – 0xEB
Reserved	0xD8 – 0xE0
	0xE5 – 0xE7
	0xEC – 0xF8

SEC Phase POST Code Table

Functionality Name (Include\ PostCode.h)	Phase	Post Code	Description
SEC_SYSTEM_POWER_ON	SEC	1	CPU power on and switch to Protected mode
SEC_BEFORE_MICROCODE_PATCH	SEC	2	Patching CPU microcode
SEC_AFTER_MICROCODE_PATCH	SEC	3	Setup Cache as RAM
SEC_ACCESS_CSR	SEC	4	PCIE MMIO Base Address initial
SEC_GENERIC_MSRINIT	SEC	5	CPU Generic MSR initialization
SEC_CPU_SPEEDCFG	SEC	6	Setup CPU speed
SEC_SETUP_CAR_OK	SEC	7	Cache as RAM test
SEC_FORCE_MAX_RATIO	SEC	8	Tune CPU frequency ratio to maximum level
SEC_GO_TO_SECSTARTUP	SEC	9	Setup BIOS ROM cache
SEC_GO_TO_PEICORE	SEC	0A	Enter Boot Firmware Volume

NOTE: The color bar items indicate 3rd party related functions that are platform dependent.

PEI Phase POST Code Table:

Functionality Name (Include\ PostCode.h)	Phase	Post Code	Description
PEI_SIO_INIT	PEI	70	Super I/O Initialization
PEI_CPU_REG_INIT	PEI	71	CPU Early Initialization
PEI_PCIE_MMIO_INIT	PEI	74	PCIE MMIO BAR Initialization
PEI_NB_REG_INIT	PEI	75	North Bridge Early Initialization
PEI_SB_REG_INIT	PEI	76	South Bridge Early Initialization

Functionality Name (Include\ PostCode.h)	Phase	Post Code	Description
PEI_TPM_INIT	PEI	78	TPM Initialization
PEI_SMBUS_INIT	PEI	79	SMBUS Early Initialization
PEI_PROGRAM_CLOCK_GEN	PEI	7A	Clock Generator Initialization
PEI_IGD_EARLY_INITIAL	PEI	7B	Internal Graphic device early Initialization
PEI_HECI_INIT	PEI	7C	HECI Initialization
PEI_WATCHDOG_INIT	PEI	7D	Watchdog timer Initialization
PEI_MEMORY_INIT	PEI	7E	Memory Initial for Normal boot.
PEI_MEMORY_INIT_FOR_CRISIS	PEI	7F	Memory Initial for Crisis Recovery
PEI_MEMORY_INSTALL	PEI	80	Simple Memory test
PEI_TXTPEI	PEI	81	TXT function early Initialization
PEI_SWITCH_STACK	PEI	82	Start to use Memory
PEI_MEMORY_CALLBACK	PEI	83	Set cache for physical memory
PEI_ENTER_RECOVERY_MODE	PEI	84	Recovery device Initialization
PEI_RECOVERY_MEDIA_FOUND	PEI	85	Found Recovery image
PEI_RECOVERY_MEDIA_NOT_FOUND	PEI	86	Recovery image not found
PEI_RECOVERY_LOAD_FILE_DONE	PEI	87	Load Recovery Image completed
PEI_RECOVERY_START_FLASH	PEI	88	Start Flash BIOS with Recovery image
PEI_ENTER_DXEIPL	PEI	89	Loading BIOS image to RAM
PEI_FINDING_DXE_CORE	PEI	8A	Loading DXE core
PEI_GO_TO_DXE_CORE	PEI	8B	Enter DXE core

DXE Phase POST Code Table:

Functionality Name (Include\ PostCode.h)	Phase	PostCode	Description
DXE_TCGDXE	DXE	40	TPM initial in DXE
DXE_SB_SPI_INIT	DXE	41	South bridge SPI initialization
DXE_CF9_RESET	DXE	42	Setup Reset service
DXE_SB_SERIAL_GPIO_INIT	DXE	43	South bridge Serial GPIO initialization
DXE_SMMACCESS	DXE	44	Setup SMM ACCE SS service
DXE_SIO_INIT	DXE	46	Super I/O DXE initialization
DXE_LEGACY_REGION	DXE	47	Setup Legacy Region service
DXE_IDENTIFY_FLASH_DEVICE	DXE	49	Identify Flash device
DXE_FTW_INIT	DXE	4A	Fault Tolerant Write verification
DXE_VARIABLE_INIT	DXE	4B	Variable Service initialization
DXE_VARIABLE_INIT_FAIL	DXE	4C	Fail to initial Variable Service
DXE_MTC_INIT	DXE	4D	MTC Initial
DXE_CPU_INIT	DXE	4E	CPU Middle Initialization
DXE_MP_CPU_INIT	DXE	4F	Multi-processor MiddleInitialization
DXE_SMBUS_INIT	DXE	50	SMBUS Driver Initialization

Functionality Name (Include PostCode.h)	Phase	PostCode	Description
DXE_SMART_TIMER_INIT	DXE	51	8259 Initialization
DXE_PCRTC_INIT	DXE	52	RTC Initialization
DXE_SATA_INIT	DXE	53	SATA Controller earlyInitialization
DXE_SMM_CONTROLER_INIT	DXE	54	Setup SMM Control service
DXE_LEGACY_INTERRUPT	DXE	55	Setup Legacy Interrupt service
DXE_RELOCATE_SMBASE	DXE	56	Relocate SMM BASE
DXE_FIRST_SMI	DXE	57	SMI test
DXE_VTD_INIT	DXE	58	VTD Initial
DXE_BEFORE_CSM16_INIT	DXE	59	Legacy BIOS Initialization
DXE_AFTER_CSM16_INIT	DXE	5A	Legacy interrupt function Initialization
DXE_LOAD_ACPI_TABLE	DXE	5B	ACPI Table Initialization
DXE_SB_DISPATCH	DXE	5C	Setup SB SMM Dispatcher service
DXE_SB_IOTRAP_INIT	DXE	5D	Setup SB IOTRAP Service
DXE_SUBCLASS_DRIVER	DXE	5E	Build AMT Table
DXE_PPM_INIT	DXE	5F	PPM Initialization
DXE_HECIDRV_INIT	DXE	60	HECIDRV Initialization

BDS Phase POST Code Table:

Functionality Name (Include PostCode.h)	Phase	Post Code	Description
BDS_ENTER_BDS	BDS	10	Enter BDS entry
BDS_INSTALL_HOTKEY	BDS	11	Install Hotkey service
BDS_ASF_INIT	BDS	12	ASF Initialization
BDS_PCI_ENUMERATION_START	BDS	13	PCI enumeration
BDS_BEFORE_PCIO_INSTALL	BDS	14	PCI resource assign complete
BDS_PCI_ENUMERATION_END	BDS	15	PCI enumeration complete
BDS_CONNECT_CONSOLE_IN	BDS	16	Keyboard Controller, Keyboard and Mouse initialization
BDS_CONNECT_CONSOLE_OUT	BDS	17	Video device initialization
BDS_CONNECT_STD_ERR	BDS	18	Error report device initialization
BDS_CONNECT_USB_HC	BDS	19	USB host controller initialization
BDS_CONNECT_USB_BUS	BDS	1A	USB BUS driver initialization
BDS_CONNECT_USB_DEVICE	BDS	1B	USB device driver initialization
BDS_NO_CONSOLE_ACTION	BDS	1C	Console device initial fail
BDS_DISPLAY_LOGO_SYSTEM_INFO	BDS	1D	Display logo or system information
BDS_START_IDE_CONTROLLER	BDS	1E	IDE controller initialization
BDS_START_SATA_CONTROLLER	BDS	1F	SATA controller initialization
BDS_START_ISA_ACPI_CONTROLLER	BDS	20	SIO controller initialization
BDS_START_ISA_BUS	BDS	21	ISA BUS driver initialization
BDS_START_ISA_FDD	BDS	22	Floppy device initialization
BDS_START_ISA_SEIRAL	BDS	23	Serial device initialization

Functionality Name (Include\ PostCode.h)	Phase	Post Code	Description
BDS_START_IDE_BUS	BDS	24	IDE device initialization
BDS_START_AHCI_BUS	BDS	25	AHCI device initialization
BDS_CONNECT_LEGACY_ROM	BDS	26	Dispatch option ROMs
BDS_ENUMERATE_ALL_BOOT_OPTION	BDS	27	Get boot device information
BDS_END_OF_BOOT_SELECTION	BDS	28	End of boot selection
BDS_ENTER_SETUP	BDS	29	Enter Setup Menu
BDS_ENTER_BOOT_MANAGER	BDS	2A	Enter Boot manager
BDS_BOOT_DEVICE_SELECT	BDS	2B	Try to boot system to OS
BDS_EFI64_SHADOW_ALL_LEGACY_ROM	BDS	2C	Shadow Misc Option ROM
BDS_ACPI_S3SAVE	BDS	2D	Save S3 resume required data in RAM
BDS_READY_TO_BOOT_EVENT	BDS	2E	Last Chipset initial before boot to OS
BDS_GO_LEGACY_BOOT	BDS	2F	Start to boot Legacy OS
BDS_GO_UEFI_BOOT	BDS	30	Start to boot UEFI OS
BDS_LEGACY16_PREPARE_TO_BOOT	BDS	31	Prepare to Boot to Legacy OS
BDS_EXIT_BOOT_SERVICES	BDS	32	Send END of POST Message to ME via HECI
BDS_LEGACY_BOOT_EVENT	BDS	33	Last Chipset initial before boot to Legacy OS.
BDS_ENTER_LEGACY_16_BOOT	BDS	34	Ready to Boot Legacy OS.
BDS_RECOVERY_START_FLASH	BDS	35	Fast Recovery Start Flash.

PostBDS POST Code Table

Functionality Name (Include\ PostCode.h)	Phase	Post Code	Description
POST_BDS_NO_BOOT_DEVICE	POST_BDS	F9	No Boot Device
POST_BDS_START_IMAGE	POST_BDS	FB	UEFI Boot Start Image
POST_BDS_ENTER_INT19	POST_BDS	FD	Legacy 16 boot entry
POST_BDS_JUMP_BOOT_SECTOR	POST_BDS	FE	Try to Boot with INT 19

S3 Functions POST Code Table

Functionality Name (Include\ PostCode.h)	Phase	Post Code	Description
POST_BDS_NO_BOOT_DEVICE	POST_BDS	F9	No Boot Device
POST_BDS_START_IMAGE	POST_BDS	FB	UEFI Boot Start Image
POST_BDS_ENTER_INT19	POST_BDS	FD	Legacy 16 boot entry
POST_BDS_JUMP_BOOT_SECTOR	POST_BDS	FE	Try to Boot with INT 19

ACPI Functions POST Code Table

Functionality Name (Include\ PostCode.h)	Phase	Post Code	Description
ASL_ENTER_S1	ASL	51	Prepare to enter S1
ASL_ENTER_S3	ASL	53	Prepare to enter S3
ASL_ENTER_S4	ASL	54	Prepare to enter S4
ASL_ENTER_S5	ASL	55	Prepare to enter S5
ASL_WAKEUP_S1	ASL	E1	System wakeup from S1
ASL_WAKEUP_S3	ASL	E3	System wakeup from S3
ASL_WAKEUP_S4	ASL	E4	System wakeup from S4

SMM Functions POST Code Table

Functionality Name (Include\ PostCode.h)	Phase	Post Code	Description
SMM_IDENTIFY_FLASH_DEVICE	SMM	0xA0	Identify Flash device in SMM
SMM_SMM_PLATFORM_INIT	SMM	0xA2	SMM service initial
SMM_ACPI_ENABLE_START	SMM	0xA6	OS call ACPI enable function
SMM_ACPI_ENABLE_END	SMM	0xA7	ACPI enable function complete
SMM_S1_SLEEP_CALLBACK	SMM	0xA1	Enter S1
SMM_S3_SLEEP_CALLBACK	SMM	0xA3	Enter S3
SMM_S4_SLEEP_CALLBACK	SMM	0xA4	Enter S4
SMM_S5_SLEEP_CALLBACK	SMM	0xA5	Enter S5
SMM_ACPI_DISABLE_START	SMM	0xA8	OS call ACPI disable function
SMM_ACPI_DISABLE_END	SMM	0xA9	ACPI disable function complete

InsydeH2ODDT Debugger POST Code Table

Functionality Name (Include\ PostCode.h)	PostCode	Description
Used by Insyde debugger	0x0D	Waiting for device connect
Used by Insyde debugger	0xD0	Waiting for device connect
Used by Insyde debugger	0xD1	InsydeH2ODDT Ready
Used by Insyde debugger	0xD2	EHCI not found
Used by Insyde debugger	0xD3	Debug port connect low speed device
Used by Insyde debugger	0xD4	DDT Cable become low speed device
Used by Insyde debugger	0xD5	DDT Cable Transmission Error (Get descriptor fail)
Used by Insyde debugger	0xD6	DDT Cable Transmission Error (Set Debug mode fail)
Used by Insyde debugger	0xD7	DDT Cable Transmission Error (Set address fail)

Jumper and Connector Locations

Mainboard Top View

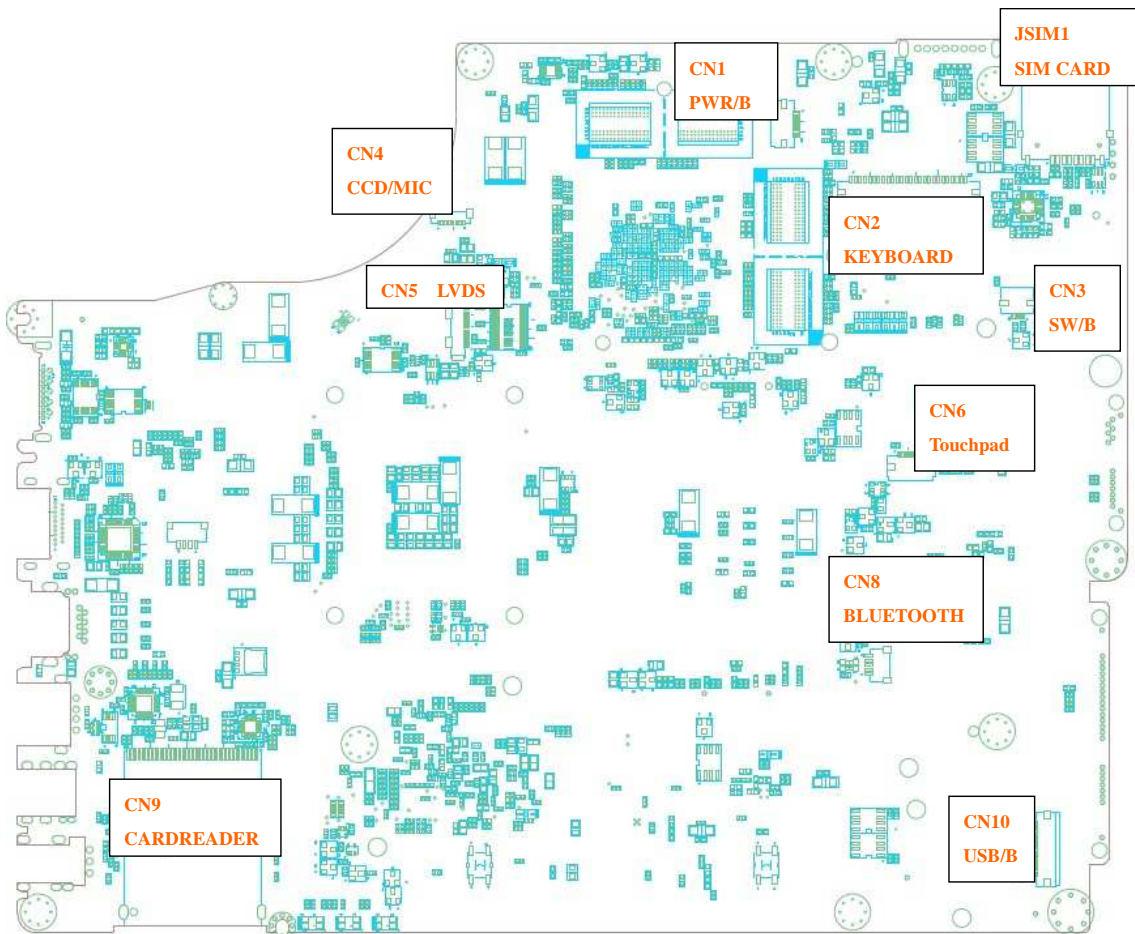

Item	Description	Item	Description
CN1	Power board connector	CN8	Bluetooth Connector
JS1M1	SIM card connector	CN10	USB board connector
CN2	Keyboard connector	CN9	Multicard reader
CN3	Switch board connector	CN5	LVDS connector
CN6	Touchpad connector	CN4	Camera/Microphone connector

Mainboard Bottom View

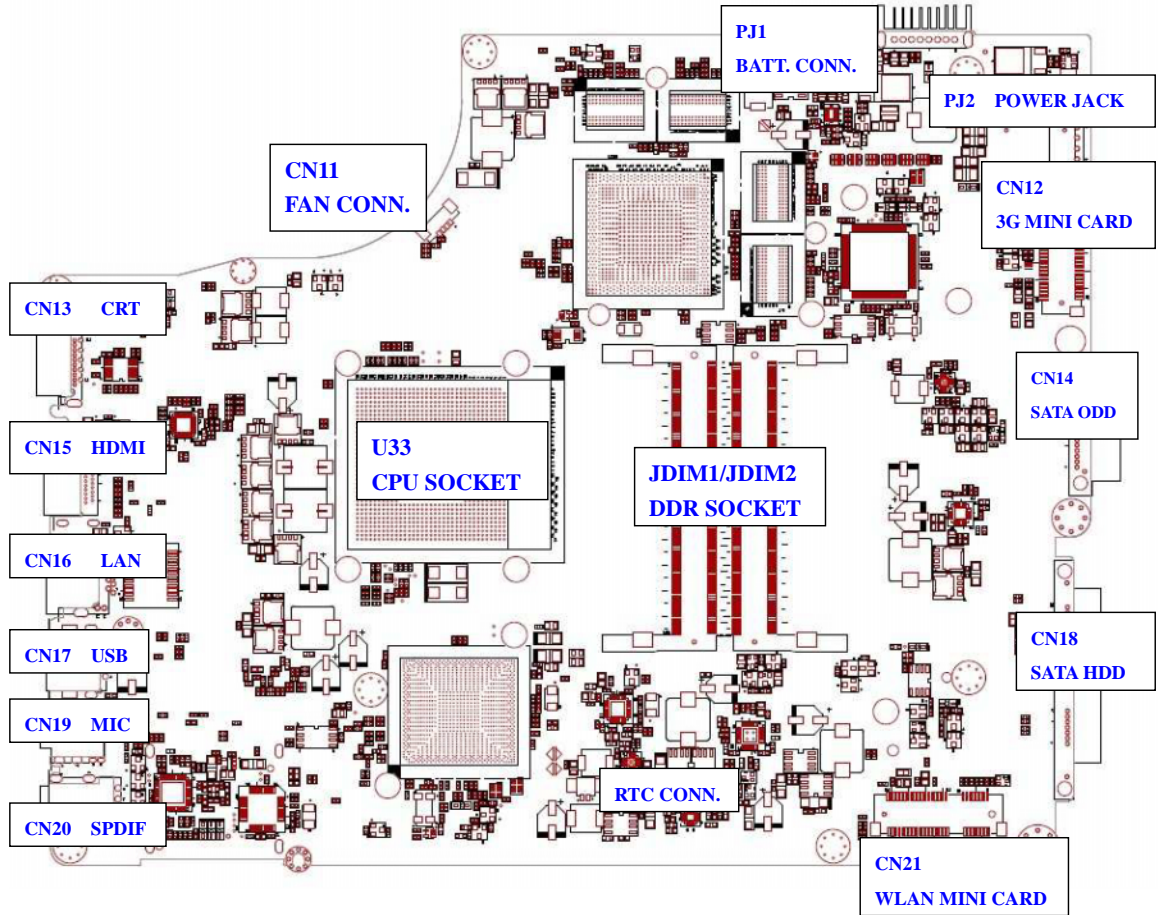

Item	Description	Item	Description
PJ1	Battery connector	CN19	Microphone connector
PJ2	Power Jack	CN17	USB connector
CN12	3G Mini card connector	CN16	LAN connector
CN14	SATA ODD connector	CN15	HDMI connector
CN18	SATA HDD connector	CN13	External CRT connector
CN21	WLAN Mini card connector	CN11	Fan connector
RTC	RTC battery connector	U33	CPU socket
CN20	SPDIF connector	JD1M1/ JD1m2	DDR Socket

BIOS Recovery

BIOS Recovery by Crisis Disk

BIOS Recovery Boot Block

The BIOS Recovery Boot Block is a special block of BIOS. It is used to boot up the system with minimum BIOS initialization. Users can enable this feature to restore the BIOS firmware to the factory settings if a BIOS flash process fails.

BIOS Recovery Hotkey

The system provides a function hotkey: **Fn+Esc**, to enable the BIOS Recovery process when a system is powered on during BIOS POST. To use this function, it is strongly recommended to have the AC adapter and Battery present. If this function is enabled, the system will force the BIOS to enter a special BIOS block, called Boot Block.

Steps for BIOS Recovery from USB Storage

Before performing this procedure, prepare a Crisis USB key. The Crisis USB key can be made by executing the Crisis Disk program in a functioning system with a Windows 7 OS.

IMPORTANT:The Crisis Disk program will overwrite all data on any drive that you use as a crisis disk.

Follow the steps below:

1. Modify the archive name from " "
2. Save ROM file (file name:) to the root directory of the USB storage.
3. Plug the USB storage into a USB port.
4. Press **Fn + ESC** button then plug in AC.
The Power button flashes once.
5. Press **Power** button to initiate system CRISIS mode.
When CRISIS is complete, the system auto restarts with a workable BIOS.
6. Update the latest version BIOS for this machine by the regular BIOS flashing process.

FRU (Field Replaceable Unit) List

This chapter gives you the FRU (Field Replaceable Unit) listing in global configurations of the computer. Refer to this chapter whenever ordering for parts to repair or for RMA (Return Merchandise Authorization).

Please note that WHEN ORDERING FRU PARTS, you should check the most up-to-date information available on your regional web or channel. For whatever reasons a part number change is made, it will not be noted on the printed Service Guide. For ACER AUTHORIZED SERVICE PROVIDERS, your Acer office may have a DIFFERENT part number code from those given in the FRU list of this printed Service Guide. You MUST use the local FRU list provided by your regional Acer office to order FRU parts for repair and service of customer machines.

NOTE: To scrap or to return the defective parts, you should follow the local government ordinance or regulations on how to dispose it properly, or follow the rules set by your regional Acer office on how to return it.

Exploded Diagrams

Main Assembly

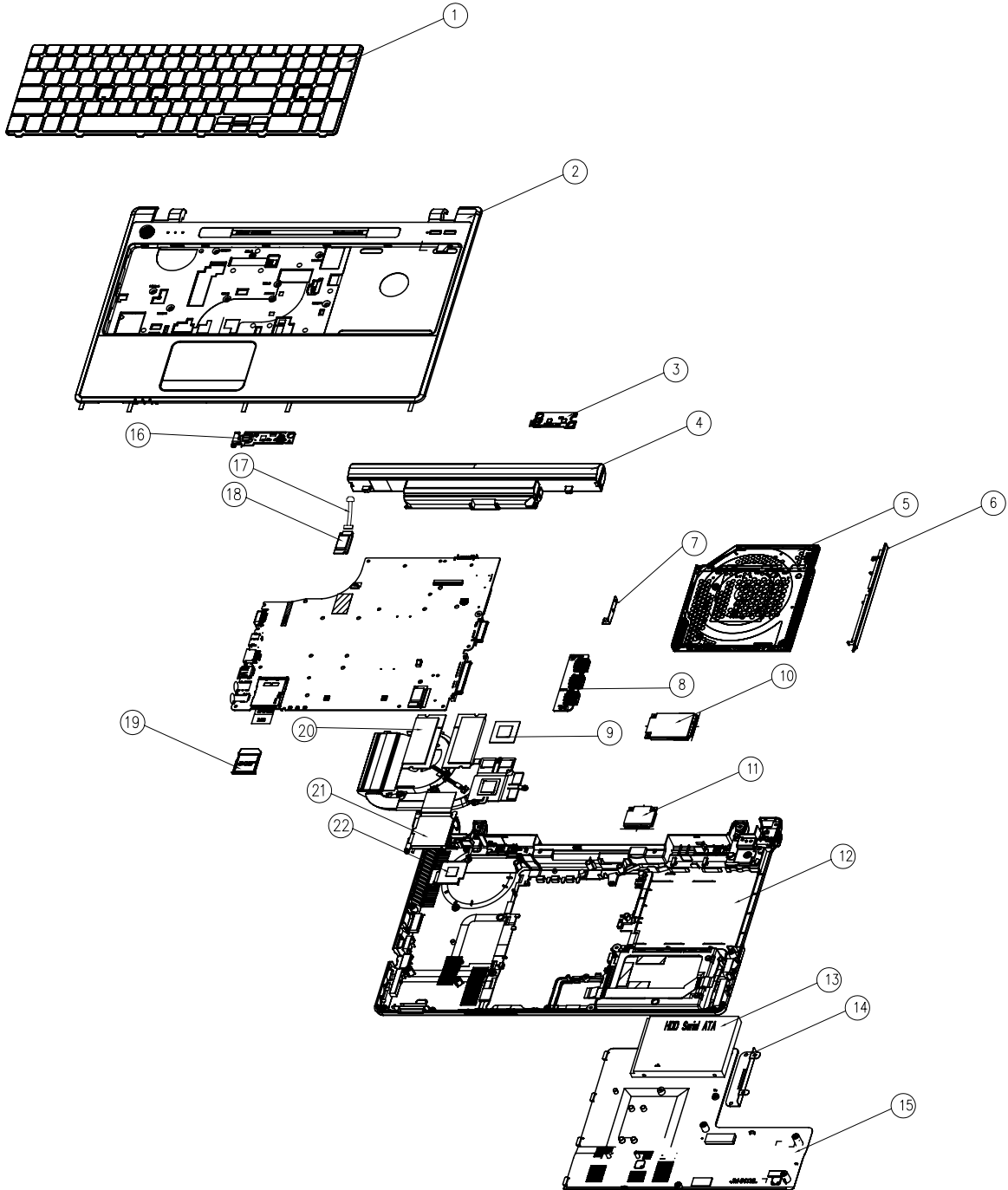

Item	Description	Part Number
1	Keyboard	KB.I170A.172
2	Top Cover	60.PTN07.002
3	Function Board	55.PTN07.003
4	Battery	BT.00606.009

Item	Description	Part Number
5	DVD/RW	6M.PU407.001
6	ODD Bezel	42.PSR07.003
7	ODD Bracket	33.PTN07.001
8	USB Board	55.PU407.002
9	CPU	KC.33001.DMP
10	WWAN Card	LC.21300.008
11	WLAN Card	NI.23600.047
12	Lower Cover	60.PTG07.001
13	HDD	KH.16008.027
14	HDD Bracket	33.EDM07.001
15	Base Door	42.PTN07.001
16	Power Board	55.PU407.001
17	Bluetooth Cable	50.PTN07.001
18	Bluetooth Module	BH.21100.004
19	Dummy Card	42.PSR07.002
20	DDR3 DIMM	KN.1GB09.012
21	Thermal Module	60.PU407.003
22	PCH Heat Sink	60.PTN07.008

NOTE: Part numbers may be different depending on your model. Please refer to the FRU List for a full listing of part numbers.



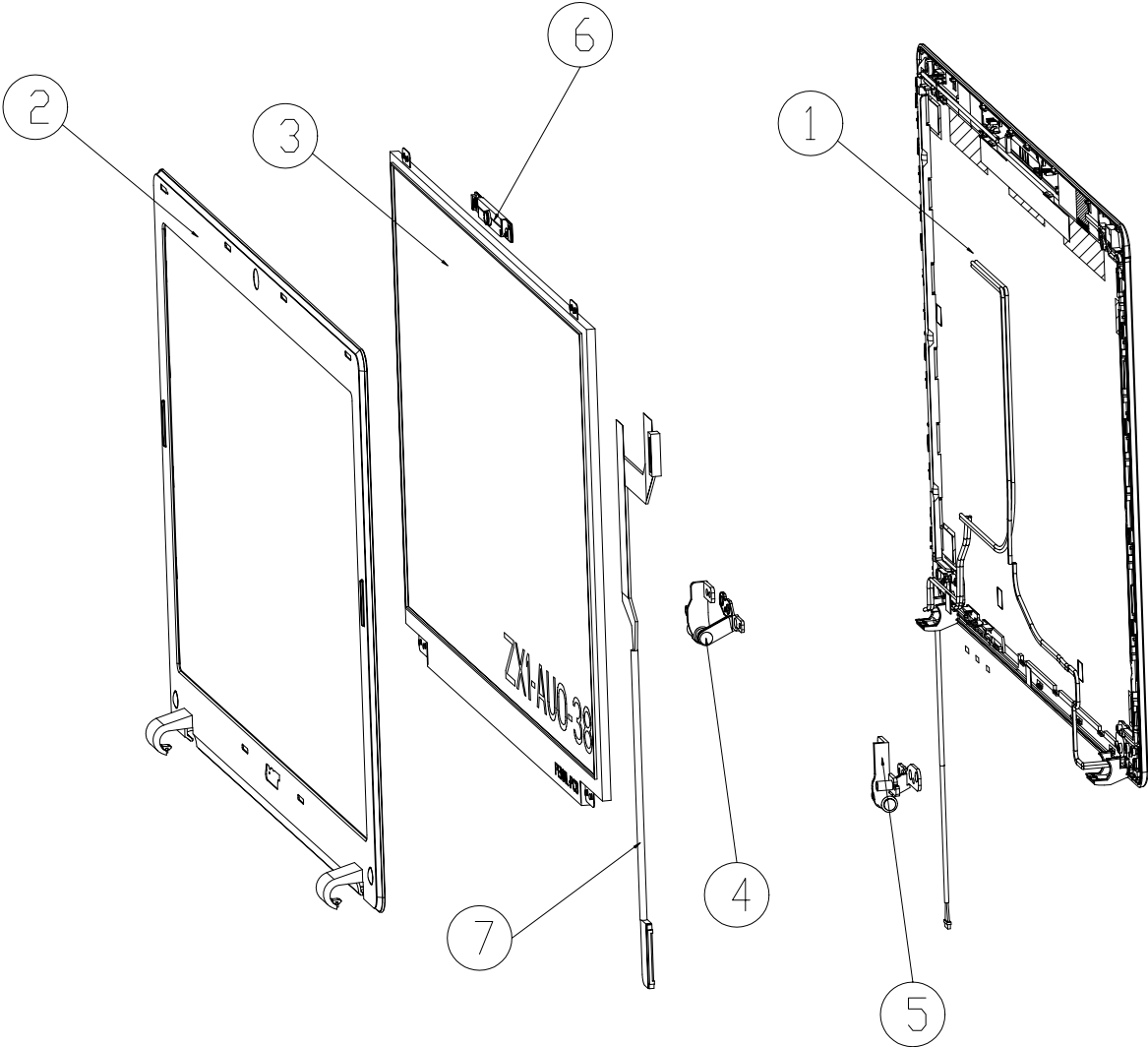



LCD Assembly













Item	Description	Part Number
1	LCD Cover	60.PTN07.004
2	LCD Bezel	60.PTN07.005
3	LCD Panel	LK.15606.008
4	LCD Hinge Left	33.PTN07.002
5	LCD Hinge Right	33.PTN07.003
6	Camera	AM.21400.068
7	Cable Assembly	50.PTN07.002



NOTE: Part numbers may be different depending on your model. Please refer to the FRU List for a full listing of part numbers.

FRU List







CATEGORY	PARTNAME	ACERPARTNO.
ADAPTER		
	Adapter DELTA 65W 19V 1.7x5.5x11 Yellow ADP-65JH DB A, LV5 LED LF	AP.06501.026
	Adapter LITE-ON 65W 19V 1.7x5.5x11 Yellow PA-1650-22AC LV5 LED LF	AP.06503.024
	Adapter HIPRO 65W 19V 1.7x5.5x11 Yellow HP-A0652R3B 1LF, LV5 LED LF	AP.0650A.012
	Adapter DELTA 90W 19V 1.7x5.5x11 Blue ADP-90CD DB A, LV5 LED LF	AP.09001.027
	Adapter LITE-ON 90W 19V 1.7x5.5x11 Blue PA-1900-34AR, LV5 LED LF	AP.09003.021
	Adapter HIPRO 90W 19V 1.7x5.5x11 Blue HP-A0904A3 B1LF, LV5 LED LF	AP.0900A.005
BATTERY		
	Battery SAMSUNG AS10B Li-Ion 3S2P SAMSUNG 6 cell 6000mAh Main COMMON ID:AS10B6E	BT.00606.009
	Battery SIMPLO AS10B Li-Ion 3S2P SAMSUNG 6 cell 6000mAh Main COMMON ID:AS10B7E	BT.00607.128
BOARD		
	USB MODEM	54.PTN07.001
	Foxconn Wireless LAN Atheros HB95 BGN (HM)	NI.23600.047
	Lan Intel WLAN 112BN.HMWG MM#903341	KI.CPH01.001
	Foxconn Wireless LAN Atheros HB93 2x2 BGN (HM)	NI.23600.062
	Huawei EM770W	LC.21300.008
		TBD
	Foxconn Bluetooth FOX BRM 2046 BT2.1	BH.21100.004
	BLUETOOTH MODULE MT77H056.00	TBD
	POWER BOARD	55.PTN07.001
	USB BOARD	55.PTN07.002
	FUNCTION BOARD	55.PTN07.003

CATEGORY	PARTNAME	ACERPARTNO.
CABLE		
	PWR CORD V943B30001218008 DANISH 3P	27.A03V7.006
	PWR CORD(ISR)1.8M 3PBLK FZ0I0008-038	27.TATV7.005
	PWR CORD V50CB3T3012180QD TW-110V,3P	27.A99V7.002
	POWER CORD(SWI)1.8M 3PBLACK FZ010008-011	27.A99V7.004
	POWER CORD(IT) 1.8M 3PBLACK FZ010008-008	27.A99V7.005
	POWER CORD(S.A) 1.8M 3BLACK FZ010008-006	27.T48V7.001
	POWER CORD US 3PIN ROHS	27.TAXV7.001
	POWER CORD(EU) 1.8M 3PBLACK FM010008-010	27.TATV7.001
	POWER CORD BRAZIL IMETRO 3 PIN	27.S0607.001
	POWER CORD UK 3PIN	27.A03V7.004
	BLUETOOTH CABLE	50.PTN07.001
CASE/COVER/BRACKET ASSEMBLY		
	LOWER CASE ASSY W/USB FFC, DC IN FOR UMA 65W	60.PTG07.001
	LOWER CASE ASSY W/USB FFC, DC IN FOR DIS 90W	60.PTN07.001
	UPPER CASE ASSY W/TP,FFC*3,W/SPK QMI	60.PTN07.002
	UPPER CASE ASSY W/TP,FFC*3,W/SPK	60.PTN07.003
	BASE COVER W/RUBBER	42.PTN07.001
	DUMMY CARD	42.PSR07.002
CPU/PROCESSOR		
	CPU Intel Core i5 520M 2.4G 3M	KC.52001.DMP
	CPU Intel Core i3 330M PGA 2.13G 35W Arrandale, TJ90, VT, 3M L3	KC.33001.DMP
	CPU Intel Core i5 430M PGA 2.26G ARD, up to SC 2.53G, 3M L3	KC.43001.DMP
	CPU Intel Core i7 720QM 1.6G 6M 1333 45W	KC.72001.QMP

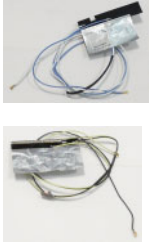
CATEGORY	PARTNAME	ACERPARTNO.
DVD RW DRIVE		
	DVD/RW SUPER MULTI 9.5MM MODULE	6M.PTN07.001
	ODD TOSHIBA Super-Multi DRIVE 9.5mm Tray DL 8X TS-U633F LF W/O bezel SATA (HF + Windows 7)	KU.00801.034
	ODD PANASONIC Super-Multi DRIVE 9.5mm Tray DL 8X UJ892 LF W/O bezel SATA GBAS2.0, (HF + Windows7)	KU.00807.068
	ODD HLDS Super-Multi DRIVE 9.5mm Tray DL 8X GU10N LF W/O bezel SATA (HF + Windows 7)	KU.0080D.049
	ODD BEZEL - 9.5mm SUPER MULTI	42.PSN07.002
	ODD BRACKET SLIM 9.5mm	33.PTN07.001
BD COMBO DRIVE		
	BLUR RAY COMBO MODULE 9.5MM	6M.PTN07.002
	ODD TOSHIBA Super-Multi DRIVE 9.5mm Tray DL 8X TS-U633F LF W/O bezel SATA (HF + Windows 7)	KU.00801.034
	ODD PANASONIC Super-Multi DRIVE 9.5mm Tray DL 8X UJ892 LF W/O bezel SATA GBAS2.0, (HF + Windows7)	KU.00807.068
	ODD HLDS Super-Multi DRIVE 9.5mm Tray DL 8X GU10N LF W/O bezel SATA (HF + Windows 7)	KU.0080D.049
	ODD BEZEL - 9.5mm COMBO	42.PTN07.002
	ODD BRACKET SLIM 9.5mm	33.PTN07.001
BD RW DRIVE		
	BLUR RAY RW MODULE 9.5MM	6M.PTN07.003
	ODD PANASONIC BD RW 12.7mm Tray DL 4X UJ240A LF W/O bezel SATA (HF+Windows 7)	KU.00407.015
	ODD BEZEL - BD RW	
	ODD BRACKET SLIM 9.5mm	33.PTN07.001

CATEGORY	PARTNAME	ACERPARTNO.
HDD/HARD DISK DRIVE		
	HDD WD 2.5" 5400rpm 160GB WD1600BEVT-22A23T0 , WD, ML320S SATA 8MB LF F/W:01.01A01	KH.16008.027
	HDD TOSHIBA 2.5" 5400rpm 160GB MK1665GSX, Capricorn BS, 320G/P SATA 8MB LF F/W:GJ001J	KH.16004.008
	HDD TOSHIBA 2.5" 5400rpm 250GB MK2565GSX, Capricorn BS, 320G/P SATA 8MB LF F/W:GJ001J	KH.25004.005
	HDD WD 2.5" 5400rpm 250GB WD2500BEVT-22A23T0, WD, ML320S SATA 8MB LF F/W:01.01A01.	KH.25008.025
	HDD TOSHIBA 2.5" 5400rpm 320GB Capricorn BS ,MK3265GSX SATA 8MB LF F/W:GJ001J	KH.32004.004
	HDD HGST 2.5" 5400rpm 320GB HTS545032B9A300 Panther B SATA LF F/W:C60F Disk imbalance criteria = 0.014g-cm	KH.32007.008
	HDD WD 2.5" 5400rpm 320GB WD3200BEVT-22A23T0,ML320S,WD SATA 8MB LF F/W:01.01A01	KH.32008.019
	HDD TOSHIBA 2.5" 5400rpm 500GB MK5065GSX,Capricorn BS, 320G/P SATA 8MB LF F/W:GJ001J	KH.50004.002
	HDD WD 2.5" 5400rpm 500GB WD5000BEVT-22A0RT0, ML320M,WD SATA 8MB LF F/W:01.01A01	KH.50008.017
	HDD WD 2.5" 5400rpm 500GB WD5000BEVT-22A0RT0, ML320M,WD SATA 8MB LF F/W:01.01A01	KH.50008.017
	HDD SEAGATE 2.5" 5400rpm 160GB ST9160314AS Wyatt SATA LF F/W:0001SDM1	KH.16001.042
	HDD HGST 2.5" 5400rpm 160GB HTS545016B9A300 Panther B SATA LF F/W:C60F Disk imbalance criteria = 0.014g-cm	KH.16007.026
	HDD SEAGATE 2.5" 5400rpm 250GB ST9250315AS Wyatt SATA LF F/W:0001SDM1	KH.25001.016
	HDD HGST 2.5" 5400rpm 250GB HTS545025B9A300 Panther B SATA LF F/W:C60F Disk imbalance criteria = 0.014g-cm	KH.25007.016
	HDD SEAGATE 2.5" 5400rpm 320GB ST9320325AS Wyatt SATA LF F/W:0001SDM1	KH.32001.017
	HDD SEAGATE 2.5" 5400rpm 500GB ST9500325AS Wyatt SATA LF F/W:0001SDM1	KH.50001.011
	HDD HGST 2.5" 5400rpm 500GB HTS545050B9A300 Panther B SATA LF F/W:C60F Disk imbalance criteria = 0.014g-cm	KH.50007.010
HDD WD 2.5" 5400rpm 640GB WD6400BEVT-22A0RT0, ML320 SATA 8MB LF F/W:01.01A01	KH.64008.004	
	HDD BRACKET	33.EDM07.001

CATEGORY	PARTNAME	ACERPARTNO.
KEYBOARD		
	Keyboard ACER AC7T_A10B AC7T Internal 17 Standard 103KS Black US International Texture	KB.I170A.172
	Keyboard ACER AC7T_A10B AC7T Internal 17 Standard 103KS Black Chinese Texture	KB.I170A.151
	Keyboard ACER AC7T_A10B AC7T Internal 17 Standard 103KS Black Greek Texture	KB.I170A.156
	Keyboard ACER AC7T_A10B AC7T Internal 17 Standard 103KS Black Thailand Texture	KB.I170A.169
	Keyboard ACER AC7T_A10B AC7T Internal 17 Standard 104KS Black SLO/CRO Texture	KB.I170A.165
	Keyboard ACER AC7T_A10B AC7T Internal 17 Standard 104KS Black CZ/SK Texture	KB.I170A.150
	Keyboard ACER AC7T_A10B AC7T Internal 17 Standard 104KS Black Hungarian Texture	KB.I170A.157
	Keyboard ACER AC7T_A10B AC7T Internal 17 Standard 104KS Black Brazilian Portuguese Texture	KB.I170A.149
	Keyboard ACER AC7T_A10B AC7T Internal 17 Standard 103KS Black Russian Texture	KB.I170A.164
	Keyboard ACER AC7T_A10B AC7T Internal 17 Standard 104KS Black Turkish Texture	KB.I170A.170
	Keyboard ACER AC7T_A10B AC7T Internal 17 Standard 104KS Black Belgium Texture	KB.I170A.148
	Keyboard ACER AC7T_A10B AC7T Internal 17 Standard 104KS Black Sweden Texture	KB.I170A.167
	Keyboard ACER AC7T_A10B AC7T Internal 17 Standard 104KS Black UK Texture	KB.I170A.171
	Keyboard ACER AC7T_A10B AC7T Internal 17 Standard 104KS Black French Texture	KB.I170A.154
	Keyboard ACER AC7T_A10B AC7T Internal 17 Standard 104KS Black German Texture	KB.I170A.155
	Keyboard ACER AC7T_A10B AC7T Internal 17 Standard 104KS Black Italian Texture	KB.I170A.158
	Keyboard ACER AC7T_A10B AC7T Internal 17 Standard 107KS Black Japanese Texture	KB.I170A.159
	Keyboard ACER AC7T_A10B AC7T Internal 17 Standard 104KS Black US w/ Canadian French Texture	KB.I170A.174
	Keyboard ACER AC7T_A10B AC7T Internal 17 Standard 104KS Black Danish Texture	KB.I170A.152
	Keyboard ACER AC7T_A10B AC7T Internal 17 Standard 104KS Black Nordic Texture	KB.I170A.161
	Keyboard ACER AC7T_A10B AC7T Internal 17 Standard 104KS Black Spanish Texture	KB.I170A.166
	Keyboard ACER AC7T_A10B AC7T Internal 17 Standard 103KS Black Arabic Texture	KB.I170A.147
	Keyboard ACER AC7T_A10B AC7T Internal 17 Standard 104KS Black FR/Arabic Texture	KB.I170A.153
Keyboard ACER AC7T_A10B AC7T Internal 17 Standard 104KS Black Swiss/G Texture	KB.I170A.168	

CATEGORY	PARTNAME	ACERPARTNO.
	Keyboard ACER AC7T_A10B AC7T Internal 17 Standard 104KS Black Portuguese Texture	KB.I170A.163
	Keyboard ACER AC7T_A10B AC7T Internal 17 Standard 103KS Black US International w/ Hebrew Texture	KB.I170A.173
	Keyboard ACER AC7T_A10B AC7T Internal 17 Standard 104KS Black Norwegian Texture	KB.I170A.162
	Keyboard ACER AC7T_A10B AC7T Internal 17 Standard 103KS Black Korean Texture	KB.I170A.160
LCD MODULE - 3G		
	LCD MODULE ASSY AL W/ANTENNA*4 FOR 3G	6M.PTN07.004
	LED LCD SAMSUNG 15.6"W WXGA Glare LTN156AT11-A01 LF 200nit 16ms 500:1 (Power saving)	LK.15606.008
	LED LCD LPL 15.6"W WXGA Glare LP156WH3-TLL1 LF 200nit 16ms 500:1 (Power saving)	LK.15608.008
	LED LCD AUO 15.6"W WXGA Glare B156XW04 V0 LF 200nit 8ms 400:1 (Power saving)	LK.15605.015
	LCD COVER ASSY AL W/MIC CCD CABLE ANTENNA*4 FOR 3G	60.PTN07.004
	LCD BEZEL ASSY FOR CCD W/RUBBER W/LOGO	60.PTN07.005
	LCD CABLE	50.PTN07.002
	LCD HINGE - L	33.PTN07.002
	LCD HINGE - R	33.PTN07.003
LCD MODULE - Non 3G		
	LCD MODULE ASSY AL W/ANTENNA*? FOR NON-3G	6M.PTN07.005

CATEGORY	PARTNAME	ACERPARTNO.
	LED LCD SAMSUNG 15.6"W WXGA Glare LTN156AT11-A01 LF 200nit 16ms 500:1 (Power saving)	LK.15606.008
	LED LCD LPL 15.6"W WXGA Glare LP156WH3-TLL1 LF 200nit 16ms 500:1 (Power saving)	LK.15608.008
	LED LCD AUO 15.6"W WXGA Glare B156XW04 V0 LF 200nit 8ms 400:1 (Power saving)	LK.15605.015
	LCD COVER ASSY AL W/MIC CCD CABLE ANTENNA*?3 FOR NON 3G	60.PTN07.006
	LCD BEZEL ASSY FOR CCD W/RUBBER W/LOGO	60.PTN07.005
	LCD CABLE	50.PTN07.002
	LCD HINGE - L	33.PTN07.002
	LCD HINGE - R	33.PTN07.003
Camera		
	Suyin 1.3M SY9665SN	AM.21400.068
	Chicony 1.3M CH9665SN (CNF9157)	AM.21400.067
	Liteon 1.3M LT9665AL (09P2SF119)	AM.21400.069
	Liteon 1.3M LT6AASP(09P2BF127)	AM.21400.070
MAINBOARD		
	MAIN BOARD UMA HM55 W/CARD READER BT W/O CPU RAM 3G	
	MAIN BOARD SG HM55 MADISON_PRO1GB W/CARD READER BT W/O CPU RAM 3G	
	MAIN BOARD SG HM55 PARK_XT512 W/CARD READER BT W/O CPU RAM 3G	
	MAIN BOARD UMA HM55 W/CARD READER BT W/O CPU RAM NON-3G	MB.PTG06.001
	MAIN BOARD SG HM55 MADISON_PRO1GB W/CARD READER BT W/O CPU RAM NON-3G	MB.PTN06.001
	MAIN BOARD SG HM55 PARK_XT512 W/CARD READER BT W/O CPU RAM NON-3G	MB.PTP06.001

CATEGORY	PARTNAME	ACERPARTNO.
MEMORY		
	Memory ELPIDA SO-DIMM DDRIII 1066 1GB EBJ10UE8BDS0-AE-F LF 128*8 0.065um	KN.1GB09.012
	Memory SAMSUNG SO-DIMM DDRIII 1066 1GB M471B2873EH1-CF8 LF 64*16 0.055um	KN.1GB0B.028
	Memory HYNIX SO-DIMM DDRIII 1066 1GB HMT112S6BFR6C-G7 N0 LF 64*16 0.055um	KN.1GB0G.025
	Memory ELPIDA SO-DIMM DDRIII 1066 2GB EBJ21UE8BDS0-AE-F LF 128*8 0.065um	KN.2GB09.006
	Memory SAMSUNG SO-DIMM DDRIII 1066 2GB M471B5673EH1-CF8 LF 128*8 0.055um	KN.2GB0B.012
	Memory HYNIX SO-DIMM DDRIII 1066 2GB HMT125S6BFR8C-G7 N0 LF 128*8 0.055um	KN.2GB0G.014
	Memory ELPIDA SO-DIMM DDRIII 1333 1GB EBJ10UE8BDS0-DJ-F LF 128*8 0.065um	KN.1GB09.015
	Memory SAMSUNG SO-DIMM DDRIII 1333 1GB M471B2873FHS-CH9 LF 128*8 46nm	KN.1GB0B.035
	Memory ELPIDA SO-DIMM DDRIII 1333 4GB EBJ41UF8BAS0-DJ-F LF 256*8 0.055um	KN.4GB09.001
	Memory SAMSUNG SO-DIMM DDRIII 1333 2GB M471B5673FH0-CH9 LF 128*8 46nm	KN.2GB0B.023
HEATSINK		
	THERMAL MODULE (UMA)	60.PTG07.002
	THERMAL MODULE (DIS)	60.PTN07.007
	HEAT SINK	60.PTN07.008
SPEAKER		
	SPEAKER MODULE (WITH L/R)	23.PTN07.001
	SPEAKER MODULE (WITH L/R)QMI	23.PTN07.002
MISCELLANEOUS		
	TOP COVER RUBBER	47.PTN07.001
	BASE RUBBER-1	47.PTN07.002
	BASE RUBBER-2	47.PTN07.003
	LCD RUBBER - 1	47.PSR07.004
	LCD RUBBER - 2	47.PSR07.005

Screw Table

Category	Description	Acer Part No.
SCREW	SCREW M2.5*4.0-I(BUWZN)(NYLON PATCH)IRON	86.EDM07.003
SCREW	SCREW M2.5*2-I (NI,NYLOK)IRON	86.EDM07.002
SCREW	SCREW M2.5*5.0-I(BZN)	86.ARE07.003
SCREW	SCREW M3*0.5+3.5I	86.N1407.007
SCREW	SCREW M2.0*3.0-I-NI-NYLOK	86.A08V7.005
SCREW		86.PTN07.001
SCREW		86.PTN07.002
SCREW	SCREW M2.0*3.0-I(BKAG)(NYLOK) IRON	86.ARE07.002
SCREW		86.PTN07.003
SCREW		86.PTN07.004
SCREW	SCREW M2.0*2.5-I (BNI,NYLOK)	86.B1907.005

Model Definition and Configuration

BOM Lists

Model	RO	Country	Acer Part No	Description
AS5820T G- 434G50M n	EMEA	Germany	LX.PTN02.160	AS5820TG-434G50Mn W7HP64ATDE1 MC MADISON_PRO1GBCKs_3V3 2*2G/500_L/ BT/6L3.0/5R/CB_bgn_1.3C_AL_DE11
AS5820T G- 434G50M n	WW	GCTWN	S2.PTN02.006	AS5820TG-434G50Mn W7HP64AWW1 MC MADISON_PRO1GBCKs_3V3 2*2G/500_L/ BT/6L3.0/5R/CB_bgn_1.3C_AL_ES61
AS5820T G- 434G50M n	CHINA	China	LX.PTN02.004	AS5820TG-434G50Mn W7HP64SCATCN1 MC MADISON_PRO1GBCKs_3V3 2*2G/ 500_L/BT/6L3.0/5R/ CB_bgn_1.3C_AL_SC14
AS5820T G- 434G50M n	EMEA	Ukraine	LX.PTN02.159	AS5820TG-434G50Mn W7HP64RUATUK1 MC MADISON_PRO1GBCKs_3V3 2*2G/ 500_L/6L3.0/5R/CB_bgn_1.3C_AL_RU61
AS5820T G- 434G50Mi	EMEA	Russia	LX.PTN02.158	AS5820TG-434G50Mi W7HP64RUATRU1 MC MADISON_PRO1GBCKs_3V3 2*2G/ 500_L/6L3.0/5R/CB_bg_1.3C_AL_RU11
AS5820T G- 434G50M n	EMEA	Middle East	LX.PTN02.157	AS5820TG-434G50Mn EM W7HP64EMATME4 MC MADISON_PRO1GBCKs_3V3 2*2G/500_L/ 6L3.0/5R/CB_bgn_1.3C_AL_RU61
AS5820T G- 434G50M n	EMEA	Middle East	LX.PTN02.156	AS5820TG-434G50Mn EM W7HP64EMATME2 MC MADISON_PRO1GBCKs_3V3 2*2G/500_L/ 6L3.0/5R/CB_bgn_1.3C_AL_ES61
AS5820T G- 434G50M n	EMEA	South Africa	LX.PTN02.155	AS5820TG-434G50Mn EM W7HP64EMATZA2 MC MADISON_PRO1GBCKs_3V3 2*2G/500_L/ 6L3.0/5R/CB_bgn_1.3C_AL_ES61
AS5820T G- 434G50M n	EMEA	Turkey	LX.PTN02.154	AS5820TG-434G50Mn EM W7HP64EMATTR1 MC MADISON_PRO1GBCKs_3V3 2*2G/500_L/ 6L3.0/5R/CB_bgn_1.3C_AL_TR31
AS5820T G- 434G50M n	EMEA	Middle East	LX.PTN02.153	AS5820TG-434G50Mn EM W7HP64EMATMEB MC MADISON_PRO1GBCKs_3V3 2*2G/500_L/ 6L3.0/5R/CB_bgn_1.3C_AL_ARA1
AS5820T G- 434G50M n	EMEA	Middle East	LX.PTN02.152	AS5820TG-434G50Mn EM W7HP64EMATME2 MC MADISON_PRO1GBCKs_3V3 2*2G/500_L/ 6L3.0/5R/CB_bgn_1.3C_AL_AR21
AS5820T G- 434G50M n	EMEA	South Africa	LX.PTN02.151	AS5820TG-434G50Mn EM W7HP64EMATZA5 MC MADISON_PRO1GBCKs_3V3 2*2G/500_L/ 6L3.0/5R/CB_bgn_1.3C_AL_ES61

Model	RO	Country	Acer Part No	Description
AS5820T G- 434G50M n	EMEA	Middle East	LX.PTN02.150	AS5820TG-434G50Mn EM W7HP64EMATME9 MC MADISON_PRO1GBCKs_3V3 2*2G/500_L/ 6L3.0/5R/CB_bgn_1.3C_AL_ES81
AS5820T G- 434G50M n	EMEA	Algeria	LX.PTN02.149	AS5820TG-434G50Mn EM W7HP64EMATDZ1 MC MADISON_PRO1GBCKs_3V3 2*2G/500_L/ 6L3.0/5R/CB_bgn_1.3C_AL_ES81
AS5820T G- 434G50M n	EMEA	South Africa	LX.PTN02.148	AS5820TG-434G50Mn EM W7HP64EMATZA1 MC MADISON_PRO1GBCKs_3V3 2*2G/500_L/ 6L3.0/5R/CB_bgn_1.3C_AL_ES81
AS5820T G- 434G50M n	EMEA	Middle East	LX.PTN02.147	AS5820TG-434G50Mn EM W7HP64EMATME4 MC MADISON_PRO1GBCKs_3V3 2*2G/500_L/ 6L3.0/5R/CB_bgn_1.3C_AL_ES61
AS5820T G- 434G50M n	EMEA	Middle East	LX.PTN02.146	AS5820TG-434G50Mn EM W7HP64EMATME2 MC MADISON_PRO1GBCKs_3V3 2*2G/500_L/ 6L3.0/5R/CB_bgn_1.3C_AL_AR11
AS5820T G- 434G50M n	EMEA	Middle East	LX.PTN02.145	AS5820TG-434G50Mn EM W7HP64EMATME3 MC MADISON_PRO1GBCKs_3V3 2*2G/500_L/ 6L3.0/5R/CB_bgn_1.3C_AL_ES81
AS5820T G- 434G50M n	EMEA	Middle East	LX.PTN02.144	AS5820TG-434G50Mn EM W7HP64EMATME6 MC MADISON_PRO1GBCKs_3V3 2*2G/500_L/ 6L3.0/5R/CB_bgn_1.3C_AL_ES61
AS5820T G- 434G50M n	EMEA	South Africa	LX.PTN02.143	AS5820TG-434G50Mn EM W7HP64EMATZA4 MC MADISON_PRO1GBCKs_3V3 2*2G/500_L/ 6L3.0/5R/CB_bgn_1.3C_AL_ES61
AS5820T G- 434G50M n	EMEA	Germany	LX.PTN02.142	AS5820TG-434G50Mn W7HP64ATDE1 MC MADISON_PRO1GBCKs_3V3 2*2G/500_L/ 6L3.0/5R/CB_bgn_1.3C_AL_DE11
AS5820T G- 434G50M n	EMEA	Poland	LX.PTN02.141	AS5820TG-434G50Mn W7HP64ATPL1 MC MADISON_PRO1GBCKs_3V3 2*2G/500_L/ 6L3.0/5R/CB_bgn_1.3C_AL_PL11
AS5820T G- 434G50M n	EMEA	Baltic	LX.PTN02.140	AS5820TG-434G50Mn W7HP64ATBC5 MC MADISON_PRO1GBCKs_3V3 2*2G/500_L/ 6L3.0/5R/CB_bgn_1.3C_AL_LT11
AS5820T G- 434G50M n	EMEA	Holland	LX.PTN02.139	AS5820TG-434G50Mn W7HP64ATNL1 MC MADISON_PRO1GBCKs_3V3 2*2G/500_L/ 6L3.0/5R/CB_bgn_1.3C_AL_NL11
AS5820T G- 434G50M n	EMEA	Belgium	LX.PTN02.138	AS5820TG-434G50Mn W7HP64ATBE1 MC MADISON_PRO1GBCKs_3V3 2*2G/500_L/ 6L3.0/5R/CB_bgn_1.3C_AL_NL11

Model	RO	Country	Acer Part No	Description
AS5820T G- 434G50M n	EMEA	Switzerland	LX.PTN02.137	AS5820TG-434G50Mn W7HP64ATCH1 MC MADISON_PRO1GBCKs_3V3 2*2G/500_L/ 6L3.0/5R/CB_bgn_1.3C_AL_IT41
AS5820T G- 434G50M n	EMEA	Luxembourg	LX.PTN02.136	AS5820TG-434G50Mn W7HP64ATLU3 MC MADISON_PRO1GBCKs_3V3 2*2G/500_L/ 6L3.0/5R/CB_bgn_1.3C_AL_IT41
AS5820T G- 434G50M n	EMEA	Latvia	LX.PTN02.135	AS5820TG-434G50Mn W7HP64ATLV1 MC MADISON_PRO1GBCKs_3V3 2*2G/500_L/ 6L3.0/5R/CB_bgn_1.3C_AL_LT11
AS5820T G- 434G50M n	EMEA	Latvia	LX.PTN02.134	AS5820TG-434G50Mn W7HP64ATLV1 MC MADISON_PRO1GBCKs_3V3 2*2G/500_L/ 6L3.0/5R/CB_bgn_1.3C_AL_RU22
AS5820T G- 434G50M n	EMEA	UK	LX.PTN02.133	AS5820TG-434G50Mn W7HP64ATGB1 MC MADISON_PRO1GBCKs_3V3 2*2G/500_L/ 6L3.0/5R/CB_bgn_1.3C_AL_EN11
AS5820T G- 434G50M n	EMEA	Eastern Europe	LX.PTN02.132	AS5820TG-434G50Mn W7HP64ATEU5 MC MADISON_PRO1GBCKs_3V3 2*2G/500_L/ 6L3.0/5R/CB_bgn_1.3C_AL_RO11
AS5820T G- 434G50M n	EMEA	Eastern Europe	LX.PTN02.131	AS5820TG-434G50Mn W7HP64ATEU5 MC MADISON_PRO1GBCKs_3V3 2*2G/500_L/ 6L3.0/5R/CB_bgn_1.3C_AL_PL71
AS5820T G- 434G50M n	EMEA	Czech	LX.PTN02.130	AS5820TG-434G50Mn W7HP64ATCZ2 MC MADISON_PRO1GBCKs_3V3 2*2G/500_L/ 6L3.0/5R/CB_bgn_1.3C_AL_SK11
AS5820T G- 434G50M n	EMEA	Hungary	LX.PTN02.129	AS5820TG-434G50Mn W7HP64ATHU1 MC MADISON_PRO1GBCKs_3V3 2*2G/500_L/ 6L3.0/5R/CB_bgn_1.3C_AL_HU11
AS5820T G- 434G50M n	EMEA	Israel	LX.PTN02.128	AS5820TG-434G50Mn W7HP64ATIL1 MC MADISON_PRO1GBCKs_3V3 2*2G/500_L/ 6L3.0/5R/CB_bgn_1.3C_AL_HE11
AS5820T G- 434G50M n	EMEA	Baltic	LX.PTN02.127	AS5820TG-434G50Mn W7HP64ATBC4 MC MADISON_PRO1GBCKs_3V3 2*2G/500_L/ 6L3.0/5R/CB_bgn_1.3C_AL_LT11
AS5820T G- 434G50M n	EMEA	Portugal	LX.PTN02.126	AS5820TG-434G50Mn W7HP64ATPT1 MC MADISON_PRO1GBCKs_3V3 2*2G/500_L/ 6L3.0/5R/CB_bgn_1.3C_AL_PT11
AS5820T G- 434G50M n	EMEA	Cyprus	LX.PTN02.125	AS5820TG-434G50Mn W7HP64ATCY1 MC MADISON_PRO1GBCKs_3V3 2*2G/500_L/ 6L3.0/5R/CB_bgn_1.3C_AL_ES61

Model	RO	Country	Acer Part No	Description
AS5820T G- 434G50M n	EMEA	Baltic	LX.PTN02.124	AS5820TG-434G50Mn W7HP64ATBC3 MC MADISON_PRO1GBCKs_3V3 2*2G/500_L/ 6L3.0/5R/CB_bgn_1.3C_AL_SV21
AS5820T G- 434G50M n	EMEA	Serbia/ Macedonia	LX.PTN02.123	AS5820TG-434G50Mn W7HP64ATCS1 MC MADISON_PRO1GBCKs_3V3 2*2G/500_L/ 6L3.0/5R/CB_bgn_1.3C_AL_SL11
AS5820T G- 434G50M n	EMEA	Italy	LX.PTN02.122	AS5820TG-434G50Mn W7HP64ATIT1 MC MADISON_PRO1GBCKs_3V3 2*2G/500_L/ 6L3.0/5R/CB_bgn_1.3C_AL_IT11
AS5820T G- 434G50M n	EMEA	Eastern Europe	LX.PTN02.121	AS5820TG-434G50Mn W7HP64ATEU7 MC MADISON_PRO1GBCKs_3V3 2*2G/500_L/ 6L3.0/5R/CB_bgn_1.3C_AL_SL11
AS5820T G- 434G50M n	EMEA	Austria	LX.PTN02.120	AS5820TG-434G50Mn W7HP64ATAT1 MC MADISON_PRO1GBCKs_3V3 2*2G/500_L/ 6L3.0/5R/CB_bgn_1.3C_AL_DE61
AS5820T G- 434G50M n	EMEA	Spain	LX.PTN02.119	AS5820TG-434G50Mn W7HP64ATES1 MC MADISON_PRO1GBCKs_3V3 2*2G/500_L/ 6L3.0/5R/CB_bgn_1.3C_AL_ES51
AS5820T G- 434G50M n	EMEA	Denmark	LX.PTN02.118	AS5820TG-434G50Mn W7HP64ATDK2 MC MADISON_PRO1GBCKs_3V3 2*2G/500_L/ 6L3.0/5R/CB_bgn_1.3C_AL_ENS1
AS5820T G- 434G50M n	EMEA	Eastern Europe	LX.PTN02.117	AS5820TG-434G50Mn W7HP64ATEU7 MC MADISON_PRO1GBCKs_3V3 2*2G/500_L/ 6L3.0/5R/CB_bgn_1.3C_AL_ENQ1
AS5820T G- 434G50M n	EMEA	Eastern Europe	LX.PTN02.116	AS5820TG-434G50Mn W7HP64ATEU4 MC MADISON_PRO1GBCKs_3V3 2*2G/500_L/ 6L3.0/5R/CB_bgn_1.3C_AL_SV21
AS5820T G- 434G50M n	EMEA	Greece	LX.PTN02.115	AS5820TG-434G50Mn W7HP64ATGR1 MC MADISON_PRO1GBCKs_3V3 2*2G/ 500_L/6L3.0/5R/CB_bgn_1.3C_AL_EL31
AS5820T G- 624G50M n	AAP	Australia/ New Zealand	LX.PTN02.114	AS5820TG-624G50Mn W7HP64ATAU1 MC MADISON_PRO1GBCKs_3V3 2*2G/500_L/ BT/6L3.0/5R/CB_bgn_1.3C_AL_ES61
AS5820T G- 434G64M n	EMEA	Middle East	LX.PTN02.113	AS5820TG-434G64Mn EM W7HP64EMATME2 MC MADISON_PRO1GBCKs_3V3 2*2G/640/ BT/9L3.0/5R/CB_bgn_1.3C_AL_AR21
AS5820T G- 434G50M n	EMEA	France	LX.PTN02.108	AS5820TG-434G50Mn W7HP64ATFR1 MC MADISON_PRO1GBCKs_3V3 2*2G/500_L/ 6L3.0/5R/CB_bgn_1.3C_AL_FR21

Model	RO	Country	Acer Part No	Description
AS5820T G- 438G50M n	WW	WW	S2.PTN02.005	AS5820TG-438G50Mn W7HP64AWW1 MC MADISON_PRO1GBCks_3V3 2*4G/500_L/ BT/6L3.0/5R/CB_bgn_1.3C_AL_ES62
AS5820T G- 434G64M n	EMEA	Spain	LX.PTN02.009	AS5820TG-434G64Mn W7HP64ATES1 MC MADISON_PRO1GBCks_3V3 2*2G/640/ BT/6L3.0/5R/CB_bgn_1.3C_AL_ES51
AS5820T G- 524G64M n	EMEA	Germany	LX.PTN02.112	AS5820TG-524G64Mn W7HP64ATDE1 MC MADISON_PRO1GBCks_3V3 2*2G/640/ BT/6L3.0/5R/CB_bgn_1.3C_AL_DE11
AS5820T G- 434G64M n	EMEA	Denmark	LX.PTN02.014	AS5820TG-434G64Mn W7HP64ATDK2 MC MADISON_PRO1GBCks_3V3 2*2G/640/ BT/6L3.0/5R/CB_bgn_1.3C_AL_ENS1
AS5820T G- 434G64Mi	EMEA	Russia	LX.PTN02.111	AS5820TG-434G64Mi W7HP64RUATRU1 MC MADISON_PRO1GBCks_3V3 2*2G/ 640/BT/6L3.0/5R/CB_bg_1.3C_AL_RU11
AS5820T G- 624G64M n	EMEA	Switzerland	LX.PTN02.110	AS5820TG-624G64Mn W7HP64ATCH1 MC MADISON_PRO1GBCks_3V3 2*2G/640/ BT/6L3.0/5R/CB_bgn_1.3C_AL_IT41
AS5820T G- 434G50M n	EMEA	Switzerland	LX.PTN02.109	AS5820TG-434G50Mn W7HP64ATCH1 MC MADISON_PRO1GBCks_3V3 2*2G/500_L/ BT/6L3.0/5R/CB_bgn_1.3C_AL_IT41
AS5820T G- 624G64M n	EMEA	Spain	LX.PTN02.107	AS5820TG-624G64Mn W7HP64ATES1 MC MADISON_PRO1GBCks_3V3 2*2G/640/ BT/9L3.0/5R/CB_bgn_1.3C_AL_ES51
AS5820T G- 626G64M n	EMEA	Spain	LX.PTN02.106	AS5820TG-626G64Mn W7HP64ATES1 MC MADISON_PRO1GBCks_3V3 4G+2G/640/ BT/6L3.0/5R/CB_bgn_1.3C_AL_ES51
AS5820T G- 624G64M n	AAP	Australia/ New Zealand	LX.PTN02.105	AS5820TG-624G64Mn W7HP64ATAU1 MC MADISON_PRO1GBCks_3V3 2*2G/640/ BT/6L3.0/5R/CB_bgn_1.3C_AL_ES61
AS5820T G- 334G50M n	AAP	Australia/ New Zealand	LX.PTN02.104	AS5820TG-334G50Mn W7HP64ATAU1 MC MADISON_PRO1GBCks_3V3 2*2G/500_L/ 6L3.0/5R/CB_bgn_1.3C_AL_ES61
AS5820T G- 524G64M n	AAP	Australia/ New Zealand	LX.PTN02.101	AS5820TG-524G64Mn W7HP64ATAU1 MC MADISON_PRO1GBCks_3V3 2*2G/640/ BT/6L3.0/5R/CB_bgn_1.3C_AL_ES61
AS5820T G- 524G50M n	AAP	Australia/ New Zealand	LX.PTN02.099	AS5820TG-524G50Mn W7HP64ATAU1 MC MADISON_PRO1GBCks_3V3 2*2G/500_L/ BT/6L3.0/5R/CB_bgn_1.3C_AL_ES61

Model	RO	Country	Acer Part No	Description
AS5820T G- 334G32M n	AAP	Australia/ New Zealand	LX.PTN02.098	AS5820TG-334G32Mn W7HP64ATAU1 MC MADISON_PRO1GBCks_3V3 2*2G/320/ 6L3.0/5R/CB_bgn_1.3C_AL_ES61
AS5820T G- 434G50M n	AAP	Australia/ New Zealand	LX.PTN02.097	AS5820TG-434G50Mn W7HP64ATAU1 MC MADISON_PRO1GBCks_3V3 2*2G/500_L/ BT/6L3.0/5R/CB_bgn_1.3C_AL_ES61
AS5820T G- 434G32M n	AAP	Australia/ New Zealand	LX.PTN02.096	AS5820TG-434G32Mn W7HP64ATAU1 MC MADISON_PRO1GBCks_3V3 2*2G/320/ BT/6L3.0/5R/CB_bgn_1.3C_AL_ES61
AS5820T G- 432G64M n	TWN	GCTWN	LX.PTN02.095	AS5820TG-432G64Mn W7HP64ATTW1 MC MADISON_PRO1GBCks_3V3 1*2G/ 640/BT/6L3.0/5R/CB_bgn_1.3C_AL_TC11
AS5820T G- 432G50M n	TWN	GCTWN	LX.PTN02.094	AS5820TG-432G50Mn W7HP64ATTW1 MC MADISON_PRO1GBCks_3V3 1*2G/ 500_L/BT/6L3.0/5R/ CB_bgn_1.3C_AL_TC11
AS5820T G- 524G64M n	TWN	GCTWN	LX.PTN02.093	AS5820TG-524G64Mn W7HP64ATTW1 MC MADISON_PRO1GBCks_3V3 2*2G/ 640/BT/6L3.0/5R/CB_bgn_1.3C_AL_TC11
AS5820T G- 438G64M n	EMEA	Ukraine	LX.PTN02.092	AS5820TG-438G64Mn W7HP64RUATUK1 MC MADISON_PRO1GBCks_3V3 2*4G/ 640/BT/9L3.0/5R/CB_bgn_1.3C_AL_RU61
AS5820T G- 438G64Mi	EMEA	Russia	LX.PTN02.091	AS5820TG-438G64Mi W7HP64RUATRU1 MC MADISON_PRO1GBCks_3V3 2*4G/ 640/BT/9L3.0/5R/CB_bg_1.3C_AL_RU11
AS5820T G- 438G64M n	EMEA	Middle East	LX.PTN02.090	AS5820TG-438G64Mn EM W7HP64EMATME4 MC MADISON_PRO1GBCks_3V3 2*4G/640/ BT/9L3.0/5R/CB_bgn_1.3C_AL_RU61
AS5820T G- 438G64M n	EMEA	Middle East	LX.PTN02.089	AS5820TG-438G64Mn EM W7HP64EMATME2 MC MADISON_PRO1GBCks_3V3 2*4G/640/ BT/9L3.0/5R/CB_bgn_1.3C_AL_ES61
AS5820T G- 438G64M n	EMEA	South Africa	LX.PTN02.088	AS5820TG-438G64Mn EM W7HP64EMATZA2 MC MADISON_PRO1GBCks_3V3 2*4G/640/ BT/9L3.0/5R/CB_bgn_1.3C_AL_ES61
AS5820T G- 438G64M n	EMEA	Turkey	LX.PTN02.087	AS5820TG-438G64Mn EM W7HP64EMATTR1 MC MADISON_PRO1GBCks_3V3 2*4G/640/ BT/9L3.0/5R/CB_bgn_1.3C_AL_TR31
AS5820T G- 438G64M n	EMEA	Middle East	LX.PTN02.086	AS5820TG-438G64Mn EM W7HP64EMATMEB MC MADISON_PRO1GBCks_3V3 2*4G/640/ BT/9L3.0/5R/CB_bgn_1.3C_AL_ARA1

Model	RO	Country	Acer Part No	Description
AS5820T G- 438G64M n	EMEA	Middle East	LX.PTN02.085	AS5820TG-438G64Mn EM W7HP64EMATME2 MC MADISON_PRO1GBCks_3V3 2*4G/640/ BT/9L3.0/5R/CB_bgn_1.3C_AL_AR21
AS5820T G- 438G64M n	EMEA	Middle East	LX.PTN02.084	AS5820TG-438G64Mn EM W7HP64EMATME9 MC MADISON_PRO1GBCks_3V3 2*4G/640/ BT/9L3.0/5R/CB_bgn_1.3C_AL_ES81
AS5820T G- 438G64M n	EMEA	Algeria	LX.PTN02.083	AS5820TG-438G64Mn EM W7HP64EMATDZ1 MC MADISON_PRO1GBCks_3V3 2*4G/640/ BT/9L3.0/5R/CB_bgn_1.3C_AL_ES81
AS5820T G- 438G64M n	EMEA	South Africa	LX.PTN02.082	AS5820TG-438G64Mn EM W7HP64EMATZA1 MC MADISON_PRO1GBCks_3V3 2*4G/640/ BT/9L3.0/5R/CB_bgn_1.3C_AL_ES81
AS5820T G- 438G64M n	EMEA	Middle East	LX.PTN02.081	AS5820TG-438G64Mn EM W7HP64EMATME4 MC MADISON_PRO1GBCks_3V3 2*4G/640/ BT/9L3.0/5R/CB_bgn_1.3C_AL_ES61
AS5820T G- 438G64M n	EMEA	Middle East	LX.PTN02.080	AS5820TG-438G64Mn EM W7HP64EMATME2 MC MADISON_PRO1GBCks_3V3 2*4G/640/ BT/9L3.0/5R/CB_bgn_1.3C_AL_AR11
AS5820T G- 438G64M n	EMEA	Middle East	LX.PTN02.079	AS5820TG-438G64Mn EM W7HP64EMATME3 MC MADISON_PRO1GBCks_3V3 2*4G/640/ BT/9L3.0/5R/CB_bgn_1.3C_AL_ES81
AS5820T G- 438G64M n	EMEA	Middle East	LX.PTN02.078	AS5820TG-438G64Mn EM W7HP64EMATME6 MC MADISON_PRO1GBCks_3V3 2*4G/640/ BT/9L3.0/5R/CB_bgn_1.3C_AL_ES61
AS5820T G- 438G64M n	EMEA	South Africa	LX.PTN02.077	AS5820TG-438G64Mn EM W7HP64EMATZA4 MC MADISON_PRO1GBCks_3V3 2*4G/640/ BT/9L3.0/5R/CB_bgn_1.3C_AL_ES61
AS5820T G- 438G64M n	EMEA	Poland	LX.PTN02.076	AS5820TG-438G64Mn W7HP64ATPL1 MC MADISON_PRO1GBCks_3V3 2*4G/640/ BT/9L3.0/5R/CB_bgn_1.3C_AL_PL11
AS5820T G- 438G64M n	EMEA	Germany	LX.PTN02.075	AS5820TG-438G64Mn W7HP64ATDE1 MC MADISON_PRO1GBCks_3V3 2*4G/640/ BT/9L3.0/5R/CB_bgn_1.3C_AL_DE11
AS5820T G- 438G64M n	EMEA	Baltic	LX.PTN02.074	AS5820TG-438G64Mn W7HP64ATBC5 MC MADISON_PRO1GBCks_3V3 2*4G/640/ BT/9L3.0/5R/CB_bgn_1.3C_AL_LT11
AS5820T G- 438G64M n	EMEA	Luxembourg	LX.PTN02.073	AS5820TG-438G64Mn W7HP64ATLU3 MC MADISON_PRO1GBCks_3V3 2*4G/640/ BT/9L3.0/5R/CB_bgn_1.3C_AL_IT41

Model	RO	Country	Acer Part No	Description
AS5820T G- 438G64M n	EMEA	Holland	LX.PTN02.072	AS5820TG-438G64Mn W7HP64ATNL1 MC MADISON_PRO1GBCKs_3V3 2*4G/640/ BT/9L3.0/5R/CB_bgn_1.3C_AL_NL11
AS5820T G- 438G64M n	EMEA	Belgium	LX.PTN02.071	AS5820TG-438G64Mn W7HP64ATBE1 MC MADISON_PRO1GBCKs_3V3 2*4G/640/ BT/9L3.0/5R/CB_bgn_1.3C_AL_NL11
AS5820T G- 438G64M n	EMEA	Switzerland	LX.PTN02.070	AS5820TG-438G64Mn W7HP64ATCH1 MC MADISON_PRO1GBCKs_3V3 2*4G/640/ BT/9L3.0/5R/CB_bgn_1.3C_AL_IT41
AS5820T G- 438G64M n	EMEA	Latvia	LX.PTN02.069	AS5820TG-438G64Mn W7HP64ATLV1 MC MADISON_PRO1GBCKs_3V3 2*4G/640/ BT/9L3.0/5R/CB_bgn_1.3C_AL_LT11
AS5820T G- 438G64M n	EMEA	Latvia	LX.PTN02.068	AS5820TG-438G64Mn W7HP64ATLV1 MC MADISON_PRO1GBCKs_3V3 2*4G/640/ BT/9L3.0/5R/CB_bgn_1.3C_AL_RU22
AS5820T G- 438G64M n	EMEA	Eastern Europe	LX.PTN02.067	AS5820TG-438G64Mn W7HP64ATEU5 MC MADISON_PRO1GBCKs_3V3 2*4G/640/ BT/9L3.0/5R/CB_bgn_1.3C_AL_RO11
AS5820T G- 438G64M n	EMEA	Eastern Europe	LX.PTN02.066	AS5820TG-438G64Mn W7HP64ATEU5 MC MADISON_PRO1GBCKs_3V3 2*4G/640/ BT/9L3.0/5R/CB_bgn_1.3C_AL_PL71
AS5820T G- 438G64M n	EMEA	UK	LX.PTN02.065	AS5820TG-438G64Mn W7HP64ATGB1 MC MADISON_PRO1GBCKs_3V3 2*4G/640/ BT/9L3.0/5R/CB_bgn_1.3C_AL_EN11
AS5820T G- 438G64M n	EMEA	Czech	LX.PTN02.064	AS5820TG-438G64Mn W7HP64ATCZ2 MC MADISON_PRO1GBCKs_3V3 2*4G/640/ BT/9L3.0/5R/CB_bgn_1.3C_AL_SK11
AS5820T G- 438G64M n	EMEA	Hungary	LX.PTN02.063	AS5820TG-438G64Mn W7HP64ATHU1 MC MADISON_PRO1GBCKs_3V3 2*4G/640/ BT/9L3.0/5R/CB_bgn_1.3C_AL_HU11
AS5820T G- 438G64M n	EMEA	Israel	LX.PTN02.062	AS5820TG-438G64Mn W7HP64ATIL1 MC MADISON_PRO1GBCKs_3V3 2*4G/640/ BT/9L3.0/5R/CB_bgn_1.3C_AL_HE11
AS5820T G- 438G64M n	EMEA	Baltic	LX.PTN02.061	AS5820TG-438G64Mn W7HP64ATBC4 MC MADISON_PRO1GBCKs_3V3 2*4G/640/ BT/9L3.0/5R/CB_bgn_1.3C_AL_LT11
AS5820T G- 438G64M n	EMEA	Cyprus	LX.PTN02.060	AS5820TG-438G64Mn W7HP64ATCY1 MC MADISON_PRO1GBCKs_3V3 2*4G/640/ BT/9L3.0/5R/CB_bgn_1.3C_AL_ES61

Model	RO	Country	Acer Part No	Description
AS5820T G- 438G64M n	EMEA	Portugal	LX.PTN02.059	AS5820TG-438G64Mn W7HP64ATPT1 MC MADISON_PRO1GBCKs_3V3 2*4G/640/ BT/9L3.0/5R/CB_bgn_1.3C_AL_PT11
AS5820T G- 438G64M n	EMEA	Baltic	LX.PTN02.058	AS5820TG-438G64Mn W7HP64ATBC3 MC MADISON_PRO1GBCKs_3V3 2*4G/640/ BT/9L3.0/5R/CB_bgn_1.3C_AL_SV21
AS5820T G- 438G64M n	EMEA	Serbia/ Macedonia	LX.PTN02.057	AS5820TG-438G64Mn W7HP64ATCS1 MC MADISON_PRO1GBCKs_3V3 2*4G/640/ BT/9L3.0/5R/CB_bgn_1.3C_AL_SL11
AS5820T G- 438G64M n	EMEA	Denmark	LX.PTN02.056	AS5820TG-438G64Mn W7HP64ATDK2 MC MADISON_PRO1GBCKs_3V3 2*4G/640/ BT/9L3.0/5R/CB_bgn_1.3C_AL_ENS1
AS5820T G- 438G64M n	EMEA	Eastern Europe	LX.PTN02.055	AS5820TG-438G64Mn W7HP64ATEU7 MC MADISON_PRO1GBCKs_3V3 2*4G/640/ BT/9L3.0/5R/CB_bgn_1.3C_AL_ENQ1
AS5820T G- 438G64M n	EMEA	Eastern Europe	LX.PTN02.054	AS5820TG-438G64Mn W7HP64ATEU4 MC MADISON_PRO1GBCKs_3V3 2*4G/640/ BT/9L3.0/5R/CB_bgn_1.3C_AL_SV21
AS5820T G- 438G64M n	EMEA	Italy	LX.PTN02.053	AS5820TG-438G64Mn W7HP64ATIT1 MC MADISON_PRO1GBCKs_3V3 2*4G/640/ BT/9L3.0/5R/CB_bgn_1.3C_AL_IT11
AS5820T G- 438G64M n	EMEA	Spain	LX.PTN02.052	AS5820TG-438G64Mn W7HP64ATES1 MC MADISON_PRO1GBCKs_3V3 2*4G/640/ BT/9L3.0/5R/CB_bgn_1.3C_AL_ES51
AS5820T G- 438G64M n	EMEA	Greece	LX.PTN02.051	AS5820TG-438G64Mn W7HP64ATGR1 MC MADISON_PRO1GBCKs_3V3 2*4G/ 640/BT/9L3.0/5R/CB_bgn_1.3C_AL_EL31
AS5820T G- 438G64M n	EMEA	Austria	LX.PTN02.050	AS5820TG-438G64Mn W7HP64ATAT1 MC MADISON_PRO1GBCKs_3V3 2*4G/640/ BT/9L3.0/5R/CB_bgn_1.3C_AL_DE61
AS5820T G- 438G64M n	EMEA	Eastern Europe	LX.PTN02.049	AS5820TG-438G64Mn W7HP64ATEU7 MC MADISON_PRO1GBCKs_3V3 2*4G/640/ BT/9L3.0/5R/CB_bgn_1.3C_AL_SL11
AS5820T G- 438G64M n	EMEA	France	LX.PTN02.048	AS5820TG-438G64Mn W7HP64ATFR1 MC MADISON_PRO1GBCKs_3V3 2*4G/640/ BT/9L3.0/5R/CB_bgn_1.3C_AL_FR21
AS5820T G- 434G64M n	EMEA	Middle East	LX.PTN02.047	AS5820TG-434G64Mn EM W7HP64EMATME4 MC MADISON_PRO1GBCKs_3V3 2*2G/640/ BT/6L3.0/5R/CB_bgn_1.3C_AL_RU61

Model	RO	Country	Acer Part No	Description
AS5820T G- 434G64M n	EMEA	Middle East	LX.PTN02.046	AS5820TG-434G64Mn EM W7HP64EMATME2 MC MADISON_PRO1GBCks_3V3 2*2G/640/ BT/6L3.0/5R/CB_bgn_1.3C_AL_ES61
AS5820T G- 434G64M n	EMEA	South Africa	LX.PTN02.045	AS5820TG-434G64Mn EM W7HP64EMATZA2 MC MADISON_PRO1GBCks_3V3 2*2G/640/ BT/6L3.0/5R/CB_bgn_1.3C_AL_ES61
AS5820T G- 434G64M n	EMEA	Turkey	LX.PTN02.044	AS5820TG-434G64Mn EM W7HP64EMATTR1 MC MADISON_PRO1GBCks_3V3 2*2G/640/ BT/6L3.0/5R/CB_bgn_1.3C_AL_TR31
AS5820T G- 434G64M n	EMEA	Middle East	LX.PTN02.043	AS5820TG-434G64Mn EM W7HP64EMATMEB MC MADISON_PRO1GBCks_3V3 2*2G/640/ BT/6L3.0/5R/CB_bgn_1.3C_AL_ARA1
AS5820T G- 434G64M n	EMEA	Middle East	LX.PTN02.042	AS5820TG-434G64Mn EM W7HP64EMATME2 MC MADISON_PRO1GBCks_3V3 2*2G/640/ BT/6L3.0/5R/CB_bgn_1.3C_AL_AR21
AS5820T G- 434G64M n	EMEA	Middle East	LX.PTN02.041	AS5820TG-434G64Mn EM W7HP64EMATME9 MC MADISON_PRO1GBCks_3V3 2*2G/640/ BT/6L3.0/5R/CB_bgn_1.3C_AL_ES81
AS5820T G- 434G64M n	EMEA	Algeria	LX.PTN02.040	AS5820TG-434G64Mn EM W7HP64EMATDZ1 MC MADISON_PRO1GBCks_3V3 2*2G/640/ BT/6L3.0/5R/CB_bgn_1.3C_AL_ES81
AS5820T G- 434G64M n	EMEA	Latvia	LX.PTN02.039	AS5820TG-434G64Mn W7HP64ATLV1 MC MADISON_PRO1GBCks_3V3 2*2G/640/ BT/6L3.0/5R/CB_bgn_1.3C_AL_RU22
AS5820T G- 434G64M n	EMEA	South Africa	LX.PTN02.038	AS5820TG-434G64Mn EM W7HP64EMATZA1 MC MADISON_PRO1GBCks_3V3 2*2G/640/ BT/6L3.0/5R/CB_bgn_1.3C_AL_ES81
AS5820T G- 434G64M n	EMEA	Middle East	LX.PTN02.037	AS5820TG-434G64Mn EM W7HP64EMATME4 MC MADISON_PRO1GBCks_3V3 2*2G/640/ BT/6L3.0/5R/CB_bgn_1.3C_AL_ES61
AS5820T G- 434G64M n	EMEA	Middle East	LX.PTN02.036	AS5820TG-434G64Mn EM W7HP64EMATME2 MC MADISON_PRO1GBCks_3V3 2*2G/640/ BT/6L3.0/5R/CB_bgn_1.3C_AL_AR11
AS5820T G- 434G64M n	EMEA	Middle East	LX.PTN02.035	AS5820TG-434G64Mn EM W7HP64EMATME3 MC MADISON_PRO1GBCks_3V3 2*2G/640/ BT/6L3.0/5R/CB_bgn_1.3C_AL_ES81
AS5820T G- 434G64M n	EMEA	Middle East	LX.PTN02.034	AS5820TG-434G64Mn EM W7HP64EMATME6 MC MADISON_PRO1GBCks_3V3 2*2G/640/ BT/6L3.0/5R/CB_bgn_1.3C_AL_ES61

Model	RO	Country	Acer Part No	Description
AS5820T G- 434G64M n	EMEA	South Africa	LX.PTN02.033	AS5820TG-434G64Mn EM W7HP64EMATZA4 MC MADISON_PRO1GBCKs_3V3 2*2G/640/ BT/6L3.0/5R/CB_bgn_1.3C_AL_ES61
AS5820T G- 434G64M n	EMEA	Poland	LX.PTN02.032	AS5820TG-434G64Mn W7HP64ATPL1 MC MADISON_PRO1GBCKs_3V3 2*2G/640/ BT/6L3.0/5R/CB_bgn_1.3C_AL_PL11
AS5820T G- 434G64M n	EMEA	Germany	LX.PTN02.031	AS5820TG-434G64Mn W7HP64ATDE1 MC MADISON_PRO1GBCKs_3V3 2*2G/640/ BT/6L3.0/5R/CB_bgn_1.3C_AL_DE11
AS5820T G- 434G64M n	EMEA	Baltic	LX.PTN02.030	AS5820TG-434G64Mn W7HP64ATBC5 MC MADISON_PRO1GBCKs_3V3 2*2G/640/ BT/6L3.0/5R/CB_bgn_1.3C_AL_LT11
AS5820T G- 434G64M n	EMEA	Luxembourg	LX.PTN02.029	AS5820TG-434G64Mn W7HP64ATLU3 MC MADISON_PRO1GBCKs_3V3 2*2G/640/ BT/6L3.0/5R/CB_bgn_1.3C_AL_IT41
AS5820T G- 434G64M n	EMEA	Holland	LX.PTN02.028	AS5820TG-434G64Mn W7HP64ATNL1 MC MADISON_PRO1GBCKs_3V3 2*2G/640/ BT/6L3.0/5R/CB_bgn_1.3C_AL_NL11
AS5820T G- 434G64M n	EMEA	Belgium	LX.PTN02.027	AS5820TG-434G64Mn W7HP64ATBE1 MC MADISON_PRO1GBCKs_3V3 2*2G/640/ BT/6L3.0/5R/CB_bgn_1.3C_AL_NL11
AS5820T G- 434G64M n	EMEA	Switzerland	LX.PTN02.026	AS5820TG-434G64Mn W7HP64ATCH1 MC MADISON_PRO1GBCKs_3V3 2*2G/640/ BT/6L3.0/5R/CB_bgn_1.3C_AL_IT41
AS5820T G- 434G64M n	EMEA	Latvia	LX.PTN02.025	AS5820TG-434G64Mn W7HP64ATLV1 MC MADISON_PRO1GBCKs_3V3 2*2G/640/ BT/6L3.0/5R/CB_bgn_1.3C_AL_LT11
AS5820T G- 434G64M n	EMEA	Eastern Europe	LX.PTN02.023	AS5820TG-434G64Mn W7HP64ATEU5 MC MADISON_PRO1GBCKs_3V3 2*2G/640/ BT/6L3.0/5R/CB_bgn_1.3C_AL_PL71
AS5820T G- 434G64M n	EMEA	Eastern Europe	LX.PTN02.024	AS5820TG-434G64Mn W7HP64ATEU5 MC MADISON_PRO1GBCKs_3V3 2*2G/640/ BT/6L3.0/5R/CB_bgn_1.3C_AL_RO11
AS5820T G- 434G64M n	EMEA	UK	LX.PTN02.022	AS5820TG-434G64Mn W7HP64ATGB1 MC MADISON_PRO1GBCKs_3V3 2*2G/640/ BT/6L3.0/5R/CB_bgn_1.3C_AL_EN11
AS5820T G- 434G64M n	EMEA	Czech	LX.PTN02.021	AS5820TG-434G64Mn W7HP64ATCZ2 MC MADISON_PRO1GBCKs_3V3 2*2G/640/ BT/6L3.0/5R/CB_bgn_1.3C_AL_SK11

Model	RO	Country	Acer Part No	Description
AS5820T G- 434G64M n	EMEA	Hungary	LX.PTN02.020	AS5820TG-434G64Mn W7HP64ATHU1 MC MADISON_PRO1GBCKs_3V3 2*2G/640/ BT/6L3.0/5R/CB_bgn_1.3C_AL_HU11
AS5820T G- 434G64M n	EMEA	Israel	LX.PTN02.019	AS5820TG-434G64Mn W7HP64ATIL1 MC MADISON_PRO1GBCKs_3V3 2*2G/640/ BT/6L3.0/5R/CB_bgn_1.3C_AL_HE11
AS5820T G- 434G64M n	EMEA	Cyprus	LX.PTN02.018	AS5820TG-434G64Mn W7HP64ATCY1 MC MADISON_PRO1GBCKs_3V3 2*2G/640/ BT/6L3.0/5R/CB_bgn_1.3C_AL_ES61
AS5820T G- 434G64M n	EMEA	Baltic	LX.PTN02.016	AS5820TG-434G64Mn W7HP64ATBC3 MC MADISON_PRO1GBCKs_3V3 2*2G/640/ BT/6L3.0/5R/CB_bgn_1.3C_AL_SV21
AS5820T G- 434G64M n	EMEA	Portugal	LX.PTN02.017	AS5820TG-434G64Mn W7HP64ATPT1 MC MADISON_PRO1GBCKs_3V3 2*2G/640/ BT/6L3.0/5R/CB_bgn_1.3C_AL_PT11
AS5820T G- 434G64M n	EMEA	Serbia/ Macedonia	LX.PTN02.015	AS5820TG-434G64Mn W7HP64ATCS1 MC MADISON_PRO1GBCKs_3V3 2*2G/640/ BT/6L3.0/5R/CB_bgn_1.3C_AL_SL11
AS5820T G- 434G64M n	EMEA	Eastern Europe	LX.PTN02.013	AS5820TG-434G64Mn W7HP64ATEU7 MC MADISON_PRO1GBCKs_3V3 2*2G/640/ BT/6L3.0/5R/CB_bgn_1.3C_AL_ENQ1
AS5820T G- 434G64M n	EMEA	Eastern Europe	LX.PTN02.012	AS5820TG-434G64Mn W7HP64ATEU4 MC MADISON_PRO1GBCKs_3V3 2*2G/640/ BT/6L3.0/5R/CB_bgn_1.3C_AL_SV21
AS5820T G- 434G64M n	EMEA	Italy	LX.PTN02.011	AS5820TG-434G64Mn W7HP64ATIT1 MC MADISON_PRO1GBCKs_3V3 2*2G/640/ BT/6L3.0/5R/CB_bgn_1.3C_AL_IT11
AS5820T G- 434G64M n	EMEA	Baltic	LX.PTN02.010	AS5820TG-434G64Mn W7HP64ATBC4 MC MADISON_PRO1GBCKs_3V3 2*2G/640/ BT/6L3.0/5R/CB_bgn_1.3C_AL_LT11
AS5820T G- 434G64M n	EMEA	Greece	LX.PTN02.008	AS5820TG-434G64Mn W7HP64ATGR1 MC MADISON_PRO1GBCKs_3V3 2*2G/ 640/BT/6L3.0/5R/CB_bgn_1.3C_AL_EL31
AS5820T G- 434G64M n	EMEA	Austria	LX.PTN02.007	AS5820TG-434G64Mn W7HP64ATAT1 MC MADISON_PRO1GBCKs_3V3 2*2G/640/ BT/6L3.0/5R/CB_bgn_1.3C_AL_DE61
AS5820T G- 434G64M n	EMEA	Eastern Europe	LX.PTN02.006	AS5820TG-434G64Mn W7HP64ATEU7 MC MADISON_PRO1GBCKs_3V3 2*2G/640/ BT/6L3.0/5R/CB_bgn_1.3C_AL_SL11

Model	RO	Country	Acer Part No	Description
AS5820T G- 434G64M n	EMEA	France	LX.PTN02.005	AS5820TG-434G64Mn W7HP64ATFR1 MC MADISON_PRO1GBCKs_3V3 2*2G/640/ BT/6L3.0/5R/CB_bgn_1.3C_AL_FR21
AS5820T G- 334G32M n	WW	WW	S2.PTN02.003	AS5820TG-334G32Mn W7HP64AWW1 MC MADISON_PRO1GBCKs_3V3 2*2G/320/ BT/6L3.0/5R/CB_bgn_1.3C_AL_ES62
AS5820T G- 624G64M n	EMEA	UK	LX.PTN02.003	AS5820TG-624G64Mn W7HP64ATGB1 MC MADISON_PRO1GBCKs_3V3 2*2G/640/ BT/9L3.0/5R/CB_bgn_1.3C_AL_EN11
AS5820T G- 438G64M n	WW	WW	S2.PTN02.004	AS5820TG-438G64Mn W7HP64AWW1 MC MADISON_PRO1GBCKs_3V3 2*4G/640/ BT/6L3.0/5R/CB_bgn_1.3C_AL_ES62
AS5820T G- 332G64M n	TWN	GCTWN	LX.PTN02.002	AS5820TG-332G64Mn W7HP64ATTW1 MC MADISON_PRO1GBCKs_3V3 1*2G/ 640/BT/6L3.0/5R/CB_bgn_1.3C_AL_TC11
AS5820T G- 522G64M n	TWN	GCTWN	LX.PTN02.001	AS5820TG-522G64Mn W7HP64ATTW1 MC MADISON_PRO1GBCKs_3V3 1*2G/ 640/BT/6L3.0/5R/CB_bgn_1.3C_AL_TC11
AS5820T G- 528G64M n	WW	WW	S2.PTN02.002	AS5820TG-528G64Mn W7HP64AWW1 MC MADISON_PRO1GBCKs_3V3 2*4G/640/ BT/6L3.0/5R/CB_bgn_1.3C_AL_ES62
AS5820T G- 524G32M n	WW	WW	S2.PTN02.001	AS5820TG-524G32Mn W7HP64AWW1 MC MADISON_PRO1GBCKs_3V3 2*2G/320/ BT/6L3.0/5R/CB_bgn_1.3C_AL_ES62
AS5820T G- 334G50M n	EMEA	Germany	LX.PTP02.106	AS5820TG-334G50Mn W7HP64ATDE1 MC PARK_XT512Cks_3V3 2*2G/500_L/BT/ 6L3.0/5R/CB_bgn_1.3C_AL_DE11
AS5820T G- 334G50M n	EMEA	Middle East	LX.PTP0C.003	AS5820TG-334G50Mn LINPUSAME2 PARK_XT512Cks_3V3 2*2G/500_L/BT/ 6L3.0/5R/CB_bgn_1.3C_AL_EN13
AS5820T G- 434G32M n	EMEA	Ukraine	LX.PTP02.105	AS5820TG-434G32Mn W7HP64RUATUK1 MC PARK_XT512Cks_3V3 2*2G/320/BT/ 6L3.0/5R/CB_bgn_1.3C_AL_RU61
AS5820T G- 434G32Mi	EMEA	Russia	LX.PTP02.104	AS5820TG-434G32Mi W7HP64RUATRU1 MC PARK_XT512Cks_3V3 2*2G/320/BT/ 6L3.0/5R/CB_bg_1.3C_AL_RU11
AS5820T G- 434G32M n	EMEA	Middle East	LX.PTP02.103	AS5820TG-434G32Mn EM W7HP64EMATME4 MC PARK_XT512Cks_3V3 2*2G/320/BT/6L3.0/ 5R/CB_bgn_1.3C_AL_RU61

Model	RO	Country	Acer Part No	Description
AS5820T G- 434G32M n	EMEA	Middle East	LX.PTP02.102	AS5820TG-434G32Mn EM W7HP64EMATME2 MC PARK_XT512Cks_3V3 2*2G/320/BT/6L3.0/ 5R/CB_bgn_1.3C_AL_ES61
AS5820T G- 434G32M n	EMEA	South Africa	LX.PTP02.101	AS5820TG-434G32Mn EM W7HP64EMATZA2 MC PARK_XT512Cks_3V3 2*2G/320/BT/6L3.0/ 5R/CB_bgn_1.3C_AL_ES61
AS5820T G- 434G32M n	EMEA	Turkey	LX.PTP02.099	AS5820TG-434G32Mn EM W7HP64EMATTR1 MC PARK_XT512Cks_3V3 2*2G/320/BT/6L3.0/ 5R/CB_bgn_1.3C_AL_TR31
AS5820T G- 434G32M n	EMEA	Middle East	LX.PTP02.098	AS5820TG-434G32Mn EM W7HP64EMATMEB MC PARK_XT512Cks_3V3 2*2G/320/BT/6L3.0/ 5R/CB_bgn_1.3C_AL_ARA1
AS5820T G- 434G32M n	EMEA	Middle East	LX.PTP02.097	AS5820TG-434G32Mn EM W7HP64EMATME2 MC PARK_XT512Cks_3V3 2*2G/320/BT/6L3.0/ 5R/CB_bgn_1.3C_AL_AR21
AS5820T G- 434G32M n	EMEA	South Africa	LX.PTP02.096	AS5820TG-434G32Mn EM W7HP64EMATZA5 MC PARK_XT512Cks_3V3 2*2G/320/BT/6L3.0/ 5R/CB_bgn_1.3C_AL_ES61
AS5820T G- 434G32M n	EMEA	Algeria	LX.PTP02.094	AS5820TG-434G32Mn EM W7HP64EMATDZ1 MC PARK_XT512Cks_3V3 2*2G/320/BT/6L3.0/ 5R/CB_bgn_1.3C_AL_ES81
AS5820T G- 434G32M n	EMEA	Middle East	LX.PTP02.095	AS5820TG-434G32Mn EM W7HP64EMATME9 MC PARK_XT512Cks_3V3 2*2G/320/BT/6L3.0/ 5R/CB_bgn_1.3C_AL_ES81
AS5820T G- 434G32M n	EMEA	South Africa	LX.PTP02.093	AS5820TG-434G32Mn EM W7HP64EMATZA1 MC PARK_XT512Cks_3V3 2*2G/320/BT/6L3.0/ 5R/CB_bgn_1.3C_AL_ES81
AS5820T G- 434G32M n	EMEA	Middle East	LX.PTP02.092	AS5820TG-434G32Mn EM W7HP64EMATME4 MC PARK_XT512Cks_3V3 2*2G/320/BT/6L3.0/ 5R/CB_bgn_1.3C_AL_ES61
AS5820T G- 434G32M n	EMEA	Middle East	LX.PTP02.091	AS5820TG-434G32Mn EM W7HP64EMATME2 MC PARK_XT512Cks_3V3 2*2G/320/BT/6L3.0/ 5R/CB_bgn_1.3C_AL_AR11
AS5820T G- 434G32M n	EMEA	Middle East	LX.PTP02.090	AS5820TG-434G32Mn EM W7HP64EMATME3 MC PARK_XT512Cks_3V3 2*2G/320/BT/6L3.0/ 5R/CB_bgn_1.3C_AL_ES81
AS5820T G- 434G32M n	EMEA	South Africa	LX.PTP02.088	AS5820TG-434G32Mn EM W7HP64EMATZA4 MC PARK_XT512Cks_3V3 2*2G/320/BT/6L3.0/ 5R/CB_bgn_1.3C_AL_ES61

Model	RO	Country	Acer Part No	Description
AS5820T G- 434G32M n	EMEA	Middle East	LX.PTP02.089	AS5820TG-434G32Mn EM W7HP64EMATME6 MC PARK_XT512Cks_3V3 2*2G/320/BT/6L3.0/ 5R/CB_bgn_1.3C_AL_ES61
AS5820T G- 434G32M n	EMEA	Germany	LX.PTP02.087	AS5820TG-434G32Mn W7HP64ATDE1 MC PARK_XT512Cks_3V3 2*2G/320/BT/6L3.0/ 5R/CB_bgn_1.3C_AL_DE11
AS5820T G- 434G32M n	EMEA	Poland	LX.PTP02.086	AS5820TG-434G32Mn W7HP64ATPL1 MC PARK_XT512Cks_3V3 2*2G/320/BT/6L3.0/ 5R/CB_bgn_1.3C_AL_PL11
AS5820T G- 434G32M n	EMEA	Baltic	LX.PTP02.085	AS5820TG-434G32Mn W7HP64ATBC5 MC PARK_XT512Cks_3V3 2*2G/320/BT/6L3.0/ 5R/CB_bgn_1.3C_AL_LT11
AS5820T G- 434G32M n	EMEA	Holland	LX.PTP02.084	AS5820TG-434G32Mn W7HP64ATNL1 MC PARK_XT512Cks_3V3 2*2G/320/BT/6L3.0/ 5R/CB_bgn_1.3C_AL_NL11
AS5820T G- 434G32M n	EMEA	Belgium	LX.PTP02.083	AS5820TG-434G32Mn W7HP64ATBE1 MC PARK_XT512Cks_3V3 2*2G/320/BT/6L3.0/ 5R/CB_bgn_1.3C_AL_NL11
AS5820T G- 434G32M n	EMEA	Switzerland	LX.PTP02.082	AS5820TG-434G32Mn W7HP64ATCH1 MC PARK_XT512Cks_3V3 2*2G/320/BT/6L3.0/ 5R/CB_bgn_1.3C_AL_IT41
AS5820T G- 434G32M n	EMEA	Luxembourg	LX.PTP02.081	AS5820TG-434G32Mn W7HP64ATLU3 MC PARK_XT512Cks_3V3 2*2G/320/BT/6L3.0/ 5R/CB_bgn_1.3C_AL_IT41
AS5820T G- 434G32M n	EMEA	Latvia	LX.PTP02.080	AS5820TG-434G32Mn W7HP64ATLV1 MC PARK_XT512Cks_3V3 2*2G/320/BT/6L3.0/ 5R/CB_bgn_1.3C_AL_LT11
AS5820T G- 434G32M n	EMEA	Latvia	LX.PTP02.079	AS5820TG-434G32Mn W7HP64ATLV1 MC PARK_XT512Cks_3V3 2*2G/320/BT/6L3.0/ 5R/CB_bgn_1.3C_AL_RU22
AS5820T G- 434G32M n	EMEA	UK	LX.PTP02.078	AS5820TG-434G32Mn W7HP64ATGB1 MC PARK_XT512Cks_3V3 2*2G/320/BT/6L3.0/ 5R/CB_bgn_1.3C_AL_EN11
AS5820T G- 434G32M n	EMEA	Eastern Europe	LX.PTP02.077	AS5820TG-434G32Mn W7HP64ATEU5 MC PARK_XT512Cks_3V3 2*2G/320/BT/6L3.0/ 5R/CB_bgn_1.3C_AL_RO11
AS5820T G- 434G32M n	EMEA	Eastern Europe	LX.PTP02.076	AS5820TG-434G32Mn W7HP64ATEU5 MC PARK_XT512Cks_3V3 2*2G/320/BT/6L3.0/ 5R/CB_bgn_1.3C_AL_PL71

Model	RO	Country	Acer Part No	Description
AS5820T G- 434G32M n	EMEA	Czech	LX.PTP02.075	AS5820TG-434G32Mn W7HP64ATCZ2 MC PARK_XT512Cks_3V3 2*2G/320/BT/6L3.0/ 5R/CB_bgn_1.3C_AL_SK11
AS5820T G- 434G32M n	EMEA	Hungary	LX.PTP02.074	AS5820TG-434G32Mn W7HP64ATHU1 MC PARK_XT512Cks_3V3 2*2G/320/BT/6L3.0/ 5R/CB_bgn_1.3C_AL_HU11
AS5820T G- 434G32M n	EMEA	Israel	LX.PTP02.073	AS5820TG-434G32Mn W7HP64ATIL1 MC PARK_XT512Cks_3V3 2*2G/320/BT/6L3.0/ 5R/CB_bgn_1.3C_AL_HE11
AS5820T G- 434G32M n	EMEA	Baltic	LX.PTP02.072	AS5820TG-434G32Mn W7HP64ATBC4 MC PARK_XT512Cks_3V3 2*2G/320/BT/6L3.0/ 5R/CB_bgn_1.3C_AL_LT11
AS5820T G- 434G32M n	EMEA	Portugal	LX.PTP02.071	AS5820TG-434G32Mn W7HP64ATPT1 MC PARK_XT512Cks_3V3 2*2G/320/BT/6L3.0/ 5R/CB_bgn_1.3C_AL_PT11
AS5820T G- 434G32M n	EMEA	Cyprus	LX.PTP02.070	AS5820TG-434G32Mn W7HP64ATCY1 MC PARK_XT512Cks_3V3 2*2G/320/BT/6L3.0/ 5R/CB_bgn_1.3C_AL_ES61
AS5820T G- 434G32M n	EMEA	Serbia/ Macedonia	LX.PTP02.068	AS5820TG-434G32Mn W7HP64ATCS1 MC PARK_XT512Cks_3V3 2*2G/320/BT/6L3.0/ 5R/CB_bgn_1.3C_AL_SL11
AS5820T G- 434G32M n	EMEA	Baltic	LX.PTP02.069	AS5820TG-434G32Mn W7HP64ATBC3 MC PARK_XT512Cks_3V3 2*2G/320/BT/6L3.0/ 5R/CB_bgn_1.3C_AL_SV21
AS5820T G- 434G32M n	EMEA	Italy	LX.PTP02.067	AS5820TG-434G32Mn W7HP64ATIT1 MC PARK_XT512Cks_3V3 2*2G/320/BT/6L3.0/ 5R/CB_bgn_1.3C_AL_IT11
AS5820T G- 434G32M n	EMEA	Spain	LX.PTP02.066	AS5820TG-434G32Mn W7HP64ATES1 MC PARK_XT512Cks_3V3 2*2G/320/BT/6L3.0/ 5R/CB_bgn_1.3C_AL_ES51
AS5820T G- 434G32M n	EMEA	Denmark	LX.PTP02.065	AS5820TG-434G32Mn W7HP64ATDK2 MC PARK_XT512Cks_3V3 2*2G/320/BT/6L3.0/ 5R/CB_bgn_1.3C_AL_ENS1
AS5820T G- 434G32M n	EMEA	Eastern Europe	LX.PTP02.064	AS5820TG-434G32Mn W7HP64ATEU7 MC PARK_XT512Cks_3V3 2*2G/320/BT/6L3.0/ 5R/CB_bgn_1.3C_AL_ENQ1
AS5820T G- 434G32M n	EMEA	Eastern Europe	LX.PTP02.063	AS5820TG-434G32Mn W7HP64ATEU4 MC PARK_XT512Cks_3V3 2*2G/320/BT/6L3.0/ 5R/CB_bgn_1.3C_AL_SV21

Model	RO	Country	Acer Part No	Description
AS5820T G- 434G32M n	EMEA	Greece	LX.PTP02.062	AS5820TG-434G32Mn W7HP64ATGR1 MC PARK_XT512Cks_3V3 2*2G/320/BT/ 6L3.0/5R/CB_bgn_1.3C_AL_EL31
AS5820T G- 434G32M n	EMEA	Austria	LX.PTP02.061	AS5820TG-434G32Mn W7HP64ATAT1 MC PARK_XT512Cks_3V3 2*2G/320/BT/6L3.0/ 5R/CB_bgn_1.3C_AL_DE61
AS5820T G- 434G32M n	EMEA	France	LX.PTP02.060	AS5820TG-434G32Mn W7HP64ATFR1 MC PARK_XT512Cks_3V3 2*2G/320/BT/6L3.0/ 5R/CB_bgn_1.3C_AL_FR21
AS5820T G- 434G32M n	EMEA	Eastern Europe	LX.PTP02.059	AS5820TG-434G32Mn W7HP64ATEU7 MC PARK_XT512Cks_3V3 2*2G/320/BT/6L3.0/ 5R/CB_bgn_1.3C_AL_SL11
AS5820T G- 434G50M n	EMEA	Eastern Europe	LX.PTP02.022	AS5820TG-434G50Mn W7HP64ATEU5 MC PARK_XT512Cks_3V3 2*2G/500_L/BT/ 6L3.0/5R/CB_bgn_1.3C_AL_RO11
AS5820T G- 434G50M n	EMEA	UK	LX.PTP02.058	AS5820TG-434G50Mn W7HP64ATGB1 MC PARK_XT512Cks_3V3 2*2G/500_L/9L3.0/ 5R/CB_bgn_1.3C_AL_EN11
AS5820T G- 334G32M n	EMEA	France	LX.PTP02.056	AS5820TG-334G32Mn W7HP64ATFR1 MC PARK_XT512Cks_3V3 2*2G/320/6L3.0/5R/ CB_bgn_1.3C_AL_FR21
AS5820T G- 334G50M n	EMEA	Spain	LX.PTP02.055	AS5820TG-334G50Mn W7HP64ATES1 MC PARK_XT512Cks_3V3 2*2G/500_L/BT/ 6L3.0/5R/CB_bgn_1.3C_AL_ES51
AS5820T G- 432G50M n	TWN	GCTWN	LX.PTP02.048	AS5820TG-432G50Mn W7HP64ATTW1 MC PARK_XT512Cks_3V3 1*2G/500_L/BT/ 6L3.0/5R/CB_bgn_1.3C_AL_TC11
AS5820T G- 434G50M n	EMEA	Denmark	LX.PTP02.005	AS5820TG-434G50Mn W7HP64ATDK2 MC PARK_XT512Cks_3V3 2*2G/500_L/BT/ 6L3.0/5R/CB_bgn_1.3C_AL_ENS1
AS5820T G- 334G50M n	EMEA	Greece	LX.PTP02.057	AS5820TG-334G50Mn W7HP64ATGR1 MC PARK_XT512Cks_3V3 2*2G/500_L/ 6L3.0/5R/CB_bgn_1.3C_AL_EL31
AS5820T G- 332G32M n	AAP	Vietnam	LX.PTP0C.002	AS5820TG-332G32Mn LINPUSAVN1 PARK_XT512Cks_3V3 1*2G/320/BT/6L3.0/ 5R/CB_bgn_1.3C_AL_EN11
AS5820T G- 333G50M n	AAP	Vietnam	LX.PTP0C.001	AS5820TG-333G50Mn LINPUSAVN1 PARK_XT512Cks_3V3 2G+1G/500_L/BT/ 6L3.0/5R/CB_bgn_1.3C_AL_EN11

Model	RO	Country	Acer Part No	Description
AS5820T G- 434G64M n	EMEA	Spain	LX.PTP02.054	AS5820TG-434G64Mn W7HP64ATES1 MC PARK_XT512Cks_3V3 2*2G/640/BT/6L3.0/ 5R/CB_bgn_1.3C_AL_ES51
AS5820T G- 434G32M n	AAP	Australia/ New Zealand	LX.PTP02.053	AS5820TG-434G32Mn W7HP64ATAU1 MC PARK_XT512Cks_3V3 2*2G/320/BT/6L3.0/ 5R/CB_bgn_1.3C_AL_ES61
AS5820T G- 434G50M n	AAP	Australia/ New Zealand	LX.PTP02.052	AS5820TG-434G50Mn W7HP64ATAU1 MC PARK_XT512Cks_3V3 2*2G/500_L/BT/ 6L3.0/5R/CB_bgn_1.3C_AL_ES61
AS5820T G- 334G50M n	AAP	Australia/ New Zealand	LX.PTP02.051	AS5820TG-334G50Mn W7HP64ATAU1 MC PARK_XT512Cks_3V3 2*2G/500_L/6L3.0/ 5R/CB_bgn_1.3C_AL_ES61
AS5820T G- 334G32M n	AAP	Australia/ New Zealand	LX.PTP02.050	AS5820TG-334G32Mn W7HP64ATAU1 MC PARK_XT512Cks_3V3 2*2G/320/6L3.0/5R/ CB_bgn_1.3C_AL_ES61
AS5820T G- 333G50M n	EMEA	Italy	LX.PTP02.049	AS5820TG-333G50Mn W7HP64ATIT1 MC PARK_XT512Cks_3V3 2G+1G/500_L/ 6L3.0/5R/CB_bgn_1.3C_AL_IT11
AS5820T G- 434G50M n	EMEA	Ukraine	LX.PTP02.047	AS5820TG-434G50Mn W7HP64RUATUK1 MC PARK_XT512Cks_3V3 2*2G/500_L/BT/ 6L3.0/5R/CB_bgn_1.3C_AL_RU61
AS5820T G- 434G50Mi	EMEA	Russia	LX.PTP02.046	AS5820TG-434G50Mi W7HP64RUATRU1 MC PARK_XT512Cks_3V3 2*2G/500_L/BT/ 6L3.0/5R/CB_bg_1.3C_AL_RU11
AS5820T G- 434G50M n	EMEA	Middle East	LX.PTP02.045	AS5820TG-434G50Mn EM W7HP64EMATME4 MC PARK_XT512Cks_3V3 2*2G/500_L/BT/ 6L3.0/5R/CB_bgn_1.3C_AL_RU61
AS5820T G- 434G50M n	EMEA	Middle East	LX.PTP02.044	AS5820TG-434G50Mn EM W7HP64EMATME4 MC PARK_XT512Cks_3V3 2*2G/500_L/BT/ 6L3.0/5R/CB_bgn_1.3C_AL_ES61
AS5820T G- 434G50M n	EMEA	Middle East	LX.PTP02.043	AS5820TG-434G50Mn EM W7HP64EMATME2 MC PARK_XT512Cks_3V3 2*2G/500_L/BT/ 6L3.0/5R/CB_bgn_1.3C_AL_AR11
AS5820T G- 434G50M n	EMEA	Middle East	LX.PTP02.042	AS5820TG-434G50Mn EM W7HP64EMATME3 MC PARK_XT512Cks_3V3 2*2G/500_L/BT/ 6L3.0/5R/CB_bgn_1.3C_AL_ES81
AS5820T G- 434G50M n	EMEA	Middle East	LX.PTP02.041	AS5820TG-434G50Mn EM W7HP64EMATME6 MC PARK_XT512Cks_3V3 2*2G/500_L/BT/ 6L3.0/5R/CB_bgn_1.3C_AL_ES61

Model	RO	Country	Acer Part No	Description
AS5820T G- 434G50M n	EMEA	South Africa	LX.PTP02.040	AS5820TG-434G50Mn EM W7HP64EMATZA4 MC PARK_XT512Cks_3V3 2*2G/500_L/BT/ 6L3.0/5R/CB_bgn_1.3C_AL_ES61
AS5820T G- 434G50M n	EMEA	Poland	LX.PTP02.039	AS5820TG-434G50Mn W7HP64ATPL1 MC PARK_XT512Cks_3V3 2*2G/500_L/BT/ 6L3.0/5R/CB_bgn_1.3C_AL_PL11
AS5820T G- 434G50M n	EMEA	Germany	LX.PTP02.038	AS5820TG-434G50Mn W7HP64ATDE1 MC PARK_XT512Cks_3V3 2*2G/500_L/BT/ 6L3.0/5R/CB_bgn_1.3C_AL_DE11
AS5820T G- 434G50M n	EMEA	Middle East	LX.PTP02.037	AS5820TG-434G50Mn EM W7HP64EMATME2 MC PARK_XT512Cks_3V3 2*2G/500_L/BT/ 6L3.0/5R/CB_bgn_1.3C_AL_ES61
AS5820T G- 434G50M n	EMEA	South Africa	LX.PTP02.036	AS5820TG-434G50Mn EM W7HP64EMATZA2 MC PARK_XT512Cks_3V3 2*2G/500_L/BT/ 6L3.0/5R/CB_bgn_1.3C_AL_ES61
AS5820T G- 434G50M n	EMEA	Turkey	LX.PTP02.035	AS5820TG-434G50Mn EM W7HP64EMATTR1 MC PARK_XT512Cks_3V3 2*2G/500_L/BT/ 6L3.0/5R/CB_bgn_1.3C_AL_TR31
AS5820T G- 434G50M n	EMEA	Middle East	LX.PTP02.034	AS5820TG-434G50Mn EM W7HP64EMATMEB MC PARK_XT512Cks_3V3 2*2G/500_L/BT/ 6L3.0/5R/CB_bgn_1.3C_AL_ARA1
AS5820T G- 434G50M n	EMEA	Middle East	LX.PTP02.033	AS5820TG-434G50Mn EM W7HP64EMATME2 MC PARK_XT512Cks_3V3 2*2G/500_L/BT/ 6L3.0/5R/CB_bgn_1.3C_AL_AR21
AS5820T G- 434G50M n	EMEA	Middle East	LX.PTP02.032	AS5820TG-434G50Mn EM W7HP64EMATME9 MC PARK_XT512Cks_3V3 2*2G/500_L/BT/ 6L3.0/5R/CB_bgn_1.3C_AL_ES81
AS5820T G- 434G50M n	EMEA	Algeria	LX.PTP02.031	AS5820TG-434G50Mn EM W7HP64EMATDZ1 MC PARK_XT512Cks_3V3 2*2G/500_L/BT/ 6L3.0/5R/CB_bgn_1.3C_AL_ES81
AS5820T G- 434G50M n	EMEA	South Africa	LX.PTP02.030	AS5820TG-434G50Mn EM W7HP64EMATZA1 MC PARK_XT512Cks_3V3 2*2G/500_L/BT/ 6L3.0/5R/CB_bgn_1.3C_AL_ES81
AS5820T G- 434G50M n	EMEA	Baltic	LX.PTP02.029	AS5820TG-434G50Mn W7HP64ATBC5 MC PARK_XT512Cks_3V3 2*2G/500_L/BT/ 6L3.0/5R/CB_bgn_1.3C_AL_LT11
AS5820T G- 434G50M n	EMEA	Luxembourg	LX.PTP02.028	AS5820TG-434G50Mn W7HP64ATLU3 MC PARK_XT512Cks_3V3 2*2G/500_L/BT/ 6L3.0/5R/CB_bgn_1.3C_AL_IT41

Model	RO	Country	Acer Part No	Description
AS5820T G- 434G50M n	EMEA	Holland	LX.PTP02.027	AS5820TG-434G50Mn W7HP64ATNL1 MC PARK_XT512Cks_3V3 2*2G/500_L/BT/ 6L3.0/5R/CB_bgn_1.3C_AL_NL11
AS5820T G- 434G50M n	EMEA	Belgium	LX.PTP02.026	AS5820TG-434G50Mn W7HP64ATBE1 MC PARK_XT512Cks_3V3 2*2G/500_L/BT/ 6L3.0/5R/CB_bgn_1.3C_AL_NL11
AS5820T G- 434G50M n	EMEA	Switzerland	LX.PTP02.025	AS5820TG-434G50Mn W7HP64ATCH1 MC PARK_XT512Cks_3V3 2*2G/500_L/BT/ 6L3.0/5R/CB_bgn_1.3C_AL_IT41
AS5820T G- 434G50M n	EMEA	Latvia	LX.PTP02.024	AS5820TG-434G50Mn W7HP64ATLV1 MC PARK_XT512Cks_3V3 2*2G/500_L/BT/ 6L3.0/5R/CB_bgn_1.3C_AL_LT11
AS5820T G- 434G50M n	EMEA	Latvia	LX.PTP02.023	AS5820TG-434G50Mn W7HP64ATLV1 MC PARK_XT512Cks_3V3 2*2G/500_L/BT/ 6L3.0/5R/CB_bgn_1.3C_AL_RU22
AS5820T G- 434G50M n	EMEA	Eastern Europe	LX.PTP02.021	AS5820TG-434G50Mn W7HP64ATEU5 MC PARK_XT512Cks_3V3 2*2G/500_L/BT/ 6L3.0/5R/CB_bgn_1.3C_AL_PL71
AS5820T G- 434G50M n	EMEA	UK	LX.PTP02.020	AS5820TG-434G50Mn W7HP64ATGB1 MC PARK_XT512Cks_3V3 2*2G/500_L/BT/ 6L3.0/5R/CB_bgn_1.3C_AL_EN11
AS5820T G- 434G50M n	EMEA	Czech	LX.PTP02.019	AS5820TG-434G50Mn W7HP64ATCZ2 MC PARK_XT512Cks_3V3 2*2G/500_L/BT/ 6L3.0/5R/CB_bgn_1.3C_AL_SK11
AS5820T G- 434G50M n	EMEA	Hungary	LX.PTP02.018	AS5820TG-434G50Mn W7HP64ATHU1 MC PARK_XT512Cks_3V3 2*2G/500_L/BT/ 6L3.0/5R/CB_bgn_1.3C_AL_HU11
AS5820T G- 434G50M n	EMEA	Israel	LX.PTP02.017	AS5820TG-434G50Mn W7HP64ATIL1 MC PARK_XT512Cks_3V3 2*2G/500_L/BT/ 6L3.0/5R/CB_bgn_1.3C_AL_HE11
AS5820T G- 434G50M n	EMEA	Baltic	LX.PTP02.016	AS5820TG-434G50Mn W7HP64ATBC4 MC PARK_XT512Cks_3V3 2*2G/500_L/BT/ 6L3.0/5R/CB_bgn_1.3C_AL_LT11
AS5820T G- 434G50M n	EMEA	Italy	LX.PTP02.015	AS5820TG-434G50Mn W7HP64ATIT1 MC PARK_XT512Cks_3V3 2*2G/500_L/BT/ 6L3.0/5R/CB_bgn_1.3C_AL_IT11
AS5820T G- 434G50M n	EMEA	Spain	LX.PTP02.014	AS5820TG-434G50Mn W7HP64ATES1 MC PARK_XT512Cks_3V3 2*2G/500_L/BT/ 6L3.0/5R/CB_bgn_1.3C_AL_ES51

Model	RO	Country	Acer Part No	Description
AS5820T G- 434G50M n	EMEA	Greece	LX.PTP02.013	AS5820TG-434G50Mn W7HP64ATGR1 MC PARK_XT512Cks_3V3 2*2G/500_L/BT/ 6L3.0/5R/CB_bgn_1.3C_AL_EL31
AS5820T G- 434G50M n	EMEA	Austria	LX.PTP02.012	AS5820TG-434G50Mn W7HP64ATAT1 MC PARK_XT512Cks_3V3 2*2G/500_L/BT/ 6L3.0/5R/CB_bgn_1.3C_AL_DE61
AS5820T G- 434G50M n	EMEA	Eastern Europe	LX.PTP02.011	AS5820TG-434G50Mn W7HP64ATEU7 MC PARK_XT512Cks_3V3 2*2G/500_L/BT/ 6L3.0/5R/CB_bgn_1.3C_AL_SL11
AS5820T G- 434G50M n	EMEA	France	LX.PTP02.010	AS5820TG-434G50Mn W7HP64ATFR1 MC PARK_XT512Cks_3V3 2*2G/500_L/BT/ 6L3.0/5R/CB_bgn_1.3C_AL_FR21
AS5820T G- 434G50M n	EMEA	Cyprus	LX.PTP02.009	AS5820TG-434G50Mn W7HP64ATCY1 MC PARK_XT512Cks_3V3 2*2G/500_L/BT/ 6L3.0/5R/CB_bgn_1.3C_AL_ES61
AS5820T G- 434G50M n	EMEA	Portugal	LX.PTP02.008	AS5820TG-434G50Mn W7HP64ATPT1 MC PARK_XT512Cks_3V3 2*2G/500_L/BT/ 6L3.0/5R/CB_bgn_1.3C_AL_PT11
AS5820T G- 434G50M n	EMEA	Baltic	LX.PTP02.007	AS5820TG-434G50Mn W7HP64ATBC3 MC PARK_XT512Cks_3V3 2*2G/500_L/BT/ 6L3.0/5R/CB_bgn_1.3C_AL_SV21
AS5820T G- 434G50M n	EMEA	Serbia/ Macedonia	LX.PTP02.006	AS5820TG-434G50Mn W7HP64ATCS1 MC PARK_XT512Cks_3V3 2*2G/500_L/BT/ 6L3.0/5R/CB_bgn_1.3C_AL_SL11
AS5820T G- 434G50M n	EMEA	Eastern Europe	LX.PTP02.004	AS5820TG-434G50Mn W7HP64ATEU7 MC PARK_XT512Cks_3V3 2*2G/500_L/BT/ 6L3.0/5R/CB_bgn_1.3C_AL_ENQ1
AS5820T G- 434G50M n	EMEA	Eastern Europe	LX.PTP02.003	AS5820TG-434G50Mn W7HP64ATEU4 MC PARK_XT512Cks_3V3 2*2G/500_L/BT/ 6L3.0/5R/CB_bgn_1.3C_AL_SV21
AS5820T G- 434G32M n	CHINA	China	LX.PTP02.002	AS5820TG-434G32Mn W7HP64SCATCN1 MC PARK_XT512Cks_3V3 2*2G/320/BT/ 6L3.0/5R/CB_bgn_1.3C_AL_SC14
AS5820T G- 524G50M n	EMEA	UK	LX.PTP02.001	AS5820TG-524G50Mn W7HP64ATGB1 MC PARK_XT512Cks_3V3 2*2G/500_L/BT/ 9L3.0/5R/CB_bgn_1.3C_AL_EN11
AS5820T G- 524G50M n	WW	WW	S2.PTP02.004	AS5820TG-524G50Mn W7HP64AWW1 MC PARK_XT512Cks_3V3 2*2G/500_L/BT/ 6L3.0/5R/CB_bgn_1.3C_AL_ES62

Model	RO	Country	Acer Part No	Description
AS5820TG-434G25Mn	WW	WW	S2.PTP02.003	AS5820TG-434G25Mn W7HP64AWW1 MC PARK_XT512Cks_3V3 2*2G/250/BT/6L3.0/5R/CB_bgn_1.3C_AL_ES62
AS5820TG-522G50Mn	WW	WW	S2.PTP02.002	AS5820TG-522G50Mn W7HP64AWW1 MC PARK_XT512Cks_3V3 2*1G/500_L/BT/6L3.0/5R/CB_bgn_1.3C_AL_ES62
AS5820TG-524G25Mn	WW	WW	S2.PTP02.001	AS5820TG-524G25Mn W7HP64AWW1 MC PARK_XT512Cks_3V3 2*2G/250/BT/6L3.0/5R/CB_bgn_1.3C_AL_ES62
AS5820T-334G32Mn	EMEA	Denmark	LX.PTG02.012	AS5820T-334G32Mn W7HP64ATDK2 MC UMACKs_3 2*2G/320/BT/6L3.0/5R/CB_bgn_1.3C_AL_ENS1
AS5820T-333G32Mn	EMEA	Ukraine	LX.PTG02.101	AS5820T-333G32Mn W7HP64RUATUK1 MC UMACKs_3 2G+1G/320/BT/6L3.0/5R/CB_bgn_1.3C_AL_RU61
AS5820T-333G32Mi	EMEA	Russia	LX.PTG02.099	AS5820T-333G32Mi W7HP64RUATRU1 MC UMACKs_3 2G+1G/320/BT/6L3.0/5R/CB_bgn_1.3C_AL_RU11
AS5820T-333G32Mn	EMEA	Middle East	LX.PTG02.098	AS5820T-333G32Mn EM W7HP64EMATME4 MC UMACKs_3 2G+1G/320/BT/6L3.0/5R/CB_bgn_1.3C_AL_RU61
AS5820T-333G32Mn	EMEA	Middle East	LX.PTG02.097	AS5820T-333G32Mn EM W7HP64EMATME2 MC UMACKs_3 2G+1G/320/BT/6L3.0/5R/CB_bgn_1.3C_AL_ES61
AS5820T-333G32Mn	EMEA	Turkey	LX.PTG02.095	AS5820T-333G32Mn EM W7HP64EMATTR1 MC UMACKs_3 2G+1G/320/BT/6L3.0/5R/CB_bgn_1.3C_AL_TR31
AS5820T-333G32Mn	EMEA	South Africa	LX.PTG02.096	AS5820T-333G32Mn EM W7HP64EMATZA2 MC UMACKs_3 2G+1G/320/BT/6L3.0/5R/CB_bgn_1.3C_AL_ES61
AS5820T-333G32Mn	EMEA	Middle East	LX.PTG02.094	AS5820T-333G32Mn EM W7HP64EMATMEB MC UMACKs_3 2G+1G/320/BT/6L3.0/5R/CB_bgn_1.3C_AL_ARA1
AS5820T-333G32Mn	EMEA	Middle East	LX.PTG02.093	AS5820T-333G32Mn EM W7HP64EMATME2 MC UMACKs_3 2G+1G/320/BT/6L3.0/5R/CB_bgn_1.3C_AL_AR21
AS5820T-333G32Mn	EMEA	South Africa	LX.PTG02.092	AS5820T-333G32Mn EM W7HP64EMATZA5 MC UMACKs_3 2G+1G/320/BT/6L3.0/5R/CB_bgn_1.3C_AL_ES61
AS5820T-333G32Mn	EMEA	Middle East	LX.PTG02.091	AS5820T-333G32Mn EM W7HP64EMATME9 MC UMACKs_3 2G+1G/320/BT/6L3.0/5R/CB_bgn_1.3C_AL_ES81
AS5820T-333G32Mn	EMEA	Algeria	LX.PTG02.090	AS5820T-333G32Mn EM W7HP64EMATDZ1 MC UMACKs_3 2G+1G/320/BT/6L3.0/5R/CB_bgn_1.3C_AL_ES81

Model	RO	Country	Acer Part No	Description
AS5820T-333G32Mn	EMEA	South Africa	LX.PTG02.089	AS5820T-333G32Mn EM W7HP64EMATZA1 MC UMACKs_3 2G+1G/320/BT/6L3.0/5R/CB_bgn_1.3C_AL_ES81
AS5820T-333G32Mn	EMEA	Middle East	LX.PTG02.088	AS5820T-333G32Mn EM W7HP64EMATME4 MC UMACKs_3 2G+1G/320/BT/6L3.0/5R/CB_bgn_1.3C_AL_ES61
AS5820T-333G32Mn	EMEA	Middle East	LX.PTG02.087	AS5820T-333G32Mn EM W7HP64EMATME2 MC UMACKs_3 2G+1G/320/BT/6L3.0/5R/CB_bgn_1.3C_AL_AR11
AS5820T-333G32Mn	EMEA	Middle East	LX.PTG02.086	AS5820T-333G32Mn EM W7HP64EMATME3 MC UMACKs_3 2G+1G/320/BT/6L3.0/5R/CB_bgn_1.3C_AL_ES81
AS5820T-333G32Mn	EMEA	Middle East	LX.PTG02.085	AS5820T-333G32Mn EM W7HP64EMATME6 MC UMACKs_3 2G+1G/320/BT/6L3.0/5R/CB_bgn_1.3C_AL_ES61
AS5820T-333G32Mn	EMEA	South Africa	LX.PTG02.084	AS5820T-333G32Mn EM W7HP64EMATZA4 MC UMACKs_3 2G+1G/320/BT/6L3.0/5R/CB_bgn_1.3C_AL_ES61
AS5820T-333G32Mn	EMEA	Germany	LX.PTG02.083	AS5820T-333G32Mn W7HP64ATDE1 MC UMACKs_3 2G+1G/320/BT/6L3.0/5R/CB_bgn_1.3C_AL_DE11
AS5820T-333G32Mn	EMEA	Poland	LX.PTG02.082	AS5820T-333G32Mn W7HP64ATPL1 MC UMACKs_3 2G+1G/320/BT/6L3.0/5R/CB_bgn_1.3C_AL_PL11
AS5820T-333G32Mn	EMEA	Baltic	LX.PTG02.081	AS5820T-333G32Mn W7HP64ATBC5 MC UMACKs_3 2G+1G/320/BT/6L3.0/5R/CB_bgn_1.3C_AL_LT11
AS5820T-333G32Mn	EMEA	Holland	LX.PTG02.080	AS5820T-333G32Mn W7HP64ATNL1 MC UMACKs_3 2G+1G/320/BT/6L3.0/5R/CB_bgn_1.3C_AL_NL11
AS5820T-333G32Mn	EMEA	Belgium	LX.PTG02.079	AS5820T-333G32Mn W7HP64ATBE1 MC UMACKs_3 2G+1G/320/BT/6L3.0/5R/CB_bgn_1.3C_AL_NL11
AS5820T-333G32Mn	EMEA	Switzerland	LX.PTG02.078	AS5820T-333G32Mn W7HP64ATCH1 MC UMACKs_3 2G+1G/320/BT/6L3.0/5R/CB_bgn_1.3C_AL_IT41
AS5820T-333G32Mn	EMEA	Luxembourg	LX.PTG02.077	AS5820T-333G32Mn W7HP64ATLU3 MC UMACKs_3 2G+1G/320/BT/6L3.0/5R/CB_bgn_1.3C_AL_IT41
AS5820T-333G32Mn	EMEA	Latvia	LX.PTG02.076	AS5820T-333G32Mn W7HP64ATLV1 MC UMACKs_3 2G+1G/320/BT/6L3.0/5R/CB_bgn_1.3C_AL_LT11
AS5820T-333G32Mn	EMEA	Latvia	LX.PTG02.075	AS5820T-333G32Mn W7HP64ATLV1 MC UMACKs_3 2G+1G/320/BT/6L3.0/5R/CB_bgn_1.3C_AL_RU22
AS5820T-333G32Mn	EMEA	UK	LX.PTG02.074	AS5820T-333G32Mn W7HP64ATGB1 MC UMACKs_3 2G+1G/320/BT/6L3.0/5R/CB_bgn_1.3C_AL_EN11

Model	RO	Country	Acer Part No	Description
AS5820T-333G32Mn	EMEA	Eastern Europe	LX.PTG02.073	AS5820T-333G32Mn W7HP64ATEU5 MC UMACKs_3 2G+1G/320/BT/6L3.0/5R/CB_bgn_1.3C_AL_RO11
AS5820T-333G32Mn	EMEA	Eastern Europe	LX.PTG02.072	AS5820T-333G32Mn W7HP64ATEU5 MC UMACKs_3 2G+1G/320/BT/6L3.0/5R/CB_bgn_1.3C_AL_PL71
AS5820T-333G32Mn	EMEA	Czech	LX.PTG02.071	AS5820T-333G32Mn W7HP64ATCZ2 MC UMACKs_3 2G+1G/320/BT/6L3.0/5R/CB_bgn_1.3C_AL_SK11
AS5820T-333G32Mn	EMEA	Hungary	LX.PTG02.070	AS5820T-333G32Mn W7HP64ATHU1 MC UMACKs_3 2G+1G/320/BT/6L3.0/5R/CB_bgn_1.3C_AL_HU11
AS5820T-333G32Mn	EMEA	Israel	LX.PTG02.069	AS5820T-333G32Mn W7HP64ATIL1 MC UMACKs_3 2G+1G/320/BT/6L3.0/5R/CB_bgn_1.3C_AL_HE11
AS5820T-333G32Mn	EMEA	Baltic	LX.PTG02.068	AS5820T-333G32Mn W7HP64ATBC4 MC UMACKs_3 2G+1G/320/BT/6L3.0/5R/CB_bgn_1.3C_AL_LT11
AS5820T-333G32Mn	EMEA	Portugal	LX.PTG02.067	AS5820T-333G32Mn W7HP64ATPT1 MC UMACKs_3 2G+1G/320/BT/6L3.0/5R/CB_bgn_1.3C_AL_PT11
AS5820T-333G32Mn	EMEA	Cyprus	LX.PTG02.066	AS5820T-333G32Mn W7HP64ATCY1 MC UMACKs_3 2G+1G/320/BT/6L3.0/5R/CB_bgn_1.3C_AL_ES61
AS5820T-333G32Mn	EMEA	Baltic	LX.PTG02.065	AS5820T-333G32Mn W7HP64ATBC3 MC UMACKs_3 2G+1G/320/BT/6L3.0/5R/CB_bgn_1.3C_AL_SV21
AS5820T-333G32Mn	EMEA	Serbia/Macedonia	LX.PTG02.064	AS5820T-333G32Mn W7HP64ATCS1 MC UMACKs_3 2G+1G/320/BT/6L3.0/5R/CB_bgn_1.3C_AL_SL11
AS5820T-333G32Mn	EMEA	Italy	LX.PTG02.063	AS5820T-333G32Mn W7HP64ATIT1 MC UMACKs_3 2G+1G/320/BT/6L3.0/5R/CB_bgn_1.3C_AL_IT11
AS5820T-333G32Mn	EMEA	Spain	LX.PTG02.062	AS5820T-333G32Mn W7HP64ATES1 MC UMACKs_3 2G+1G/320/BT/6L3.0/5R/CB_bgn_1.3C_AL_ES51
AS5820T-333G32Mn	EMEA	Denmark	LX.PTG02.061	AS5820T-333G32Mn W7HP64ATDK2 MC UMACKs_3 2G+1G/320/BT/6L3.0/5R/CB_bgn_1.3C_AL_ENS1
AS5820T-333G32Mn	EMEA	Eastern Europe	LX.PTG02.060	AS5820T-333G32Mn W7HP64ATEU7 MC UMACKs_3 2G+1G/320/BT/6L3.0/5R/CB_bgn_1.3C_AL_ENQ1
AS5820T-333G32Mn	EMEA	Eastern Europe	LX.PTG02.059	AS5820T-333G32Mn W7HP64ATEU4 MC UMACKs_3 2G+1G/320/BT/6L3.0/5R/CB_bgn_1.3C_AL_SV21
AS5820T-333G32Mn	EMEA	Greece	LX.PTG02.058	AS5820T-333G32Mn W7HP64ATGR1 MC UMACKs_3 2G+1G/320/BT/6L3.0/5R/CB_bgn_1.3C_AL_EL31
AS5820T-333G32Mn	EMEA	Austria	LX.PTG02.057	AS5820T-333G32Mn W7HP64ATAT1 MC UMACKs_3 2G+1G/320/BT/6L3.0/5R/CB_bgn_1.3C_AL_DE61

Model	RO	Country	Acer Part No	Description
AS5820T-333G32Mn	EMEA	France	LX.PTG02.056	AS5820T-333G32Mn W7HP64ATFR1 MC UMACKs_3 2G+1G/320/BT/6L3.0/5R/CB_bgn_1.3C_AL_FR21
AS5820T-333G32Mn	EMEA	Eastern Europe	LX.PTG02.055	AS5820T-333G32Mn W7HP64ATEU7 MC UMACKs_3 2G+1G/320/BT/6L3.0/5R/CB_bgn_1.3C_AL_SL11
AS5820T-334G32Mn	EMEA	Italy	LX.PTG02.049	AS5820T-334G32Mn W7HP64ATIT1 MC UMACKs_3 2*2G/320/6L3.0/5R/CB_bgn_1.3C_AL_IT11
AS5820T-334G50Mn	EMEA	Spain	LX.PTG02.054	AS5820T-334G50Mn W7HP64ATES1 MC UMACKs_3 2*2G/500_L/6L3.0/5R/CB_bgn_1.3C_AL_ES51
AS5820T-434G50Mn	AAP	Australia/ New Zealand	LX.PTG02.053	AS5820T-434G50Mn W7HP64ATAU1 MC UMACKs_3 2*2G/500_L/BT/6L3.0/5R/CB_bgn_1.3C_AL_ES61
AS5820T-434G32Mn	AAP	Australia/ New Zealand	LX.PTG02.052	AS5820T-434G32Mn W7HP64ATAU1 MC UMACKs_3 2*2G/320/BT/6L3.0/5R/CB_bgn_1.3C_AL_ES61
AS5820T-334G50Mn	AAP	Australia/ New Zealand	LX.PTG02.051	AS5820T-334G50Mn W7HP64ATAU1 MC UMACKs_3 2*2G/500_L/6L3.0/5R/CB_bgn_1.3C_AL_ES61
AS5820T-334G32Mn	AAP	Australia/ New Zealand	LX.PTG02.050	AS5820T-334G32Mn W7HP64ATAU1 MC UMACKs_3 2*2G/320/6L3.0/5R/CB_bgn_1.3C_AL_ES61
AS5820T-334G32Mn	EMEA	Ukraine	LX.PTG02.048	AS5820T-334G32Mn W7HP64RUATUK1 MC UMACKs_3 2*2G/320/BT/6L3.0/5R/CB_bgn_1.3C_AL_RU61
AS5820T-334G32Mi	EMEA	Russia	LX.PTG02.047	AS5820T-334G32Mi W7HP64RUATRU1 MC UMACKs_3 2*2G/320/BT/6L3.0/5R/CB_bgn_1.3C_AL_RU11
AS5820T-334G32Mn	EMEA	Middle East	LX.PTG02.046	AS5820T-334G32Mn EM W7HP64EMATME4 MC UMACKs_3 2*2G/320/BT/6L3.0/5R/CB_bgn_1.3C_AL_RU61
AS5820T-334G32Mn	EMEA	Middle East	LX.PTG02.045	AS5820T-334G32Mn EM W7HP64EMATME2 MC UMACKs_3 2*2G/320/BT/6L3.0/5R/CB_bgn_1.3C_AL_ES61
AS5820T-334G32Mn	EMEA	South Africa	LX.PTG02.044	AS5820T-334G32Mn EM W7HP64EMATZA2 MC UMACKs_3 2*2G/320/BT/6L3.0/5R/CB_bgn_1.3C_AL_ES61
AS5820T-334G32Mn	EMEA	Turkey	LX.PTG02.043	AS5820T-334G32Mn EM W7HP64EMATTR1 MC UMACKs_3 2*2G/320/BT/6L3.0/5R/CB_bgn_1.3C_AL_TR31
AS5820T-334G32Mn	EMEA	Middle East	LX.PTG02.042	AS5820T-334G32Mn EM W7HP64EMATMEB MC UMACKs_3 2*2G/320/BT/6L3.0/5R/CB_bgn_1.3C_AL_ARA1
AS5820T-334G32Mn	EMEA	Middle East	LX.PTG02.041	AS5820T-334G32Mn EM W7HP64EMATME2 MC UMACKs_3 2*2G/320/BT/6L3.0/5R/CB_bgn_1.3C_AL_AR21
AS5820T-334G32Mn	EMEA	Middle East	LX.PTG02.040	AS5820T-334G32Mn EM W7HP64EMATME9 MC UMACKs_3 2*2G/320/BT/6L3.0/5R/CB_bgn_1.3C_AL_ES81

Model	RO	Country	Acer Part No	Description
AS5820T-334G32Mn	EMEA	Algeria	LX.PTG02.039	AS5820T-334G32Mn EM W7HP64EMATDZ1 MC UMACKs_3 2*2G/320/BT/6L3.0/5R/CB_bgn_1.3C_AL_ES81
AS5820T-334G32Mn	EMEA	South Africa	LX.PTG02.038	AS5820T-334G32Mn EM W7HP64EMATZA1 MC UMACKs_3 2*2G/320/BT/6L3.0/5R/CB_bgn_1.3C_AL_ES81
AS5820T-334G32Mn	EMEA	Middle East	LX.PTG02.037	AS5820T-334G32Mn EM W7HP64EMATME4 MC UMACKs_3 2*2G/320/BT/6L3.0/5R/CB_bgn_1.3C_AL_ES61
AS5820T-334G32Mn	EMEA	Middle East	LX.PTG02.036	AS5820T-334G32Mn EM W7HP64EMATME2 MC UMACKs_3 2*2G/320/BT/6L3.0/5R/CB_bgn_1.3C_AL_AR11
AS5820T-334G32Mn	EMEA	Middle East	LX.PTG02.035	AS5820T-334G32Mn EM W7HP64EMATME3 MC UMACKs_3 2*2G/320/BT/6L3.0/5R/CB_bgn_1.3C_AL_ES81
AS5820T-334G32Mn	EMEA	Middle East	LX.PTG02.034	AS5820T-334G32Mn EM W7HP64EMATME6 MC UMACKs_3 2*2G/320/BT/6L3.0/5R/CB_bgn_1.3C_AL_ES61
AS5820T-334G32Mn	EMEA	South Africa	LX.PTG02.033	AS5820T-334G32Mn EM W7HP64EMATZA4 MC UMACKs_3 2*2G/320/BT/6L3.0/5R/CB_bgn_1.3C_AL_ES61
AS5820T-334G32Mn	EMEA	Poland	LX.PTG02.032	AS5820T-334G32Mn W7HP64ATPL1 MC UMACKs_3 2*2G/320/BT/6L3.0/5R/CB_bgn_1.3C_AL_PL11
AS5820T-334G32Mn	EMEA	Germany	LX.PTG02.031	AS5820T-334G32Mn W7HP64ATDE1 MC UMACKs_3 2*2G/320/BT/6L3.0/5R/CB_bgn_1.3C_AL_DE11
AS5820T-334G32Mn	EMEA	Baltic	LX.PTG02.030	AS5820T-334G32Mn W7HP64ATBC5 MC UMACKs_3 2*2G/320/BT/6L3.0/5R/CB_bgn_1.3C_AL_LT11
AS5820T-334G32Mn	EMEA	Luxembourg	LX.PTG02.029	AS5820T-334G32Mn W7HP64ATLU3 MC UMACKs_3 2*2G/320/BT/6L3.0/5R/CB_bgn_1.3C_AL_IT41
AS5820T-334G32Mn	EMEA	Holland	LX.PTG02.028	AS5820T-334G32Mn W7HP64ATNL1 MC UMACKs_3 2*2G/320/BT/6L3.0/5R/CB_bgn_1.3C_AL_NL11
AS5820T-334G32Mn	EMEA	Belgium	LX.PTG02.027	AS5820T-334G32Mn W7HP64ATBE1 MC UMACKs_3 2*2G/320/BT/6L3.0/5R/CB_bgn_1.3C_AL_NL11
AS5820T-334G32Mn	EMEA	Switzerland	LX.PTG02.026	AS5820T-334G32Mn W7HP64ATCH1 MC UMACKs_3 2*2G/320/BT/6L3.0/5R/CB_bgn_1.3C_AL_IT41
AS5820T-334G32Mn	EMEA	Latvia	LX.PTG02.025	AS5820T-334G32Mn W7HP64ATLV1 MC UMACKs_3 2*2G/320/BT/6L3.0/5R/CB_bgn_1.3C_AL_LT11
AS5820T-334G32Mn	EMEA	Latvia	LX.PTG02.024	AS5820T-334G32Mn W7HP64ATLV1 MC UMACKs_3 2*2G/320/BT/6L3.0/5R/CB_bgn_1.3C_AL_RU22
AS5820T-334G32Mn	EMEA	Eastern Europe	LX.PTG02.023	AS5820T-334G32Mn W7HP64ATEU5 MC UMACKs_3 2*2G/320/BT/6L3.0/5R/CB_bgn_1.3C_AL_RO11

Model	RO	Country	Acer Part No	Description
AS5820T-334G32Mn	EMEA	Eastern Europe	LX.PTG02.022	AS5820T-334G32Mn W7HP64ATEU5 MC UMACKs_3 2*2G/320/BT/6L3.0/5R/CB_bgn_1.3C_AL_PL71
AS5820T-334G32Mn	EMEA	UK	LX.PTG02.021	AS5820T-334G32Mn W7HP64ATGB1 MC UMACKs_3 2*2G/320/BT/6L3.0/5R/CB_bgn_1.3C_AL_EN11
AS5820T-334G32Mn	EMEA	Czech	LX.PTG02.020	AS5820T-334G32Mn W7HP64ATCZ2 MC UMACKs_3 2*2G/320/BT/6L3.0/5R/CB_bgn_1.3C_AL_SK11
AS5820T-334G32Mn	EMEA	Hungary	LX.PTG02.019	AS5820T-334G32Mn W7HP64ATHU1 MC UMACKs_3 2*2G/320/BT/6L3.0/5R/CB_bgn_1.3C_AL_HU11
AS5820T-334G32Mn	EMEA	Israel	LX.PTG02.018	AS5820T-334G32Mn W7HP64ATIL1 MC UMACKs_3 2*2G/320/BT/6L3.0/5R/CB_bgn_1.3C_AL_HE11
AS5820T-334G32Mn	EMEA	Baltic	LX.PTG02.017	AS5820T-334G32Mn W7HP64ATBC4 MC UMACKs_3 2*2G/320/BT/6L3.0/5R/CB_bgn_1.3C_AL_LT11
AS5820T-334G32Mn	EMEA	Cyprus	LX.PTG02.016	AS5820T-334G32Mn W7HP64ATCY1 MC UMACKs_3 2*2G/320/BT/6L3.0/5R/CB_bgn_1.3C_AL_ES61
AS5820T-334G32Mn	EMEA	Portugal	LX.PTG02.015	AS5820T-334G32Mn W7HP64ATPT1 MC UMACKs_3 2*2G/320/BT/6L3.0/5R/CB_bgn_1.3C_AL_PT11
AS5820T-334G32Mn	EMEA	Baltic	LX.PTG02.014	AS5820T-334G32Mn W7HP64ATBC3 MC UMACKs_3 2*2G/320/BT/6L3.0/5R/CB_bgn_1.3C_AL_SV21
AS5820T-334G32Mn	EMEA	Serbia/Macedonia	LX.PTG02.013	AS5820T-334G32Mn W7HP64ATCS1 MC UMACKs_3 2*2G/320/BT/6L3.0/5R/CB_bgn_1.3C_AL_SL11
AS5820T-334G32Mn	EMEA	Eastern Europe	LX.PTG02.011	AS5820T-334G32Mn W7HP64ATEU7 MC UMACKs_3 2*2G/320/BT/6L3.0/5R/CB_bgn_1.3C_AL_ENQ1
AS5820T-334G32Mn	EMEA	Eastern Europe	LX.PTG02.010	AS5820T-334G32Mn W7HP64ATEU4 MC UMACKs_3 2*2G/320/BT/6L3.0/5R/CB_bgn_1.3C_AL_SV21
AS5820T-334G32Mn	EMEA	Italy	LX.PTG02.009	AS5820T-334G32Mn W7HP64ATIT1 MC UMACKs_3 2*2G/320/BT/6L3.0/5R/CB_bgn_1.3C_AL_IT11
AS5820T-334G32Mn	EMEA	Spain	LX.PTG02.008	AS5820T-334G32Mn W7HP64ATES1 MC UMACKs_3 2*2G/320/BT/6L3.0/5R/CB_bgn_1.3C_AL_ES51
AS5820T-334G32Mn	EMEA	Greece	LX.PTG02.007	AS5820T-334G32Mn W7HP64ATGR1 MC UMACKs_3 2*2G/320/BT/6L3.0/5R/CB_bgn_1.3C_AL_EL31
AS5820T-334G32Mn	EMEA	Austria	LX.PTG02.006	AS5820T-334G32Mn W7HP64ATAT1 MC UMACKs_3 2*2G/320/BT/6L3.0/5R/CB_bgn_1.3C_AL_DE61
AS5820T-334G32Mn	EMEA	Eastern Europe	LX.PTG02.005	AS5820T-334G32Mn W7HP64ATEU7 MC UMACKs_3 2*2G/320/BT/6L3.0/5R/CB_bgn_1.3C_AL_SL11

Model	RO	Country	Acer Part No	Description
AS5820T-334G32Mn	EMEA	France	LX.PTG02.004	AS5820T-334G32Mn W7HP64ATFR1 MC UMACKs_3 2*2G/320/BT/6L3.0/5R/CB_bgn_1.3C_AL_FR21
AS5820T-432G32Mn	CHINA	China	LX.PTG02.003	AS5820T-432G32Mn W7HP64SCATCN1 MC UMACKs_3 1*2G/320/BT/6L3.0/5R/CB_bgn_1.3C_AL_SC14
AS5820T-434G50Mn	EMEA	UK	LX.PTG02.002	AS5820T-434G50Mn W7HP64ATGB1 MC UMACKs_3 2*2G/500_L/BT/9L3.0/5R/CB_bgn_1.3C_AL_EN11
AS5820T-333G32Mn	EMEA	UK	LX.PTG02.001	AS5820T-333G32Mn W7HP64ATGB1 MC UMACKs_3 2G+1G/320/6L3.0/5R/CB_bgn_1.3C_AL_EN11
AS5820T-332G16Mn	WW	WW	S2.PTG02.003	AS5820T-332G16Mn W7HP64AWW1 MC UMACKs_3 2*1G/160/6L3.0/5R/CB_bgn_1.3C_AL_ES62
AS5820T-522G16Mn	WW	WW	S2.PTG02.002	AS5820T-522G16Mn W7HP64AWW1 MC UMACKs_3 2*1G/160/BT/6L3.0/5R/CB_bgn_1.3C_AL_ES62
AS5820T-524G16Mn	WW	WW	S2.PTG02.001	AS5820T-524G16Mn W7HP64AWW1 MC UMACKs_3 2*2G/160/BT/6L3.0/5R/CB_bgn_1.3C_AL_ES62

Model	CPU	VGA Chip	VRAM 1	Memory 1	Memory 2	HDD 1(GB)
AS5820TG-434G50Mn	Ci5430M	MADISON_PRO	1G-DDR3 (64*16*8)	SO2GBIII10	SO2GBIII10	N500GB 5.4KS
AS5820TG-434G50Mn	Ci5430M	MADISON_PRO	1G-DDR3 (64*16*8)	SO2GBIII10	SO2GBIII10	N500GB 5.4KS
AS5820TG-434G50Mn	Ci5430M	MADISON_PRO	1G-DDR3 (64*16*8)	SO2GBIII10	SO2GBIII10	N500GB 5.4KS
AS5820TG-434G50Mn	Ci5430M	MADISON_PRO	1G-DDR3 (64*16*8)	SO2GBIII10	SO2GBIII10	N500GB 5.4KS
AS5820TG-434G50Mi	Ci5430M	MADISON_PRO	1G-DDR3 (64*16*8)	SO2GBIII10	SO2GBIII10	N500GB 5.4KS
AS5820TG-434G50Mn	Ci5430M	MADISON_PRO	1G-DDR3 (64*16*8)	SO2GBIII10	SO2GBIII10	N500GB 5.4KS
AS5820TG-434G50Mn	Ci5430M	MADISON_PRO	1G-DDR3 (64*16*8)	SO2GBIII10	SO2GBIII10	N500GB 5.4KS
AS5820TG-434G50Mn	Ci5430M	MADISON_PRO	1G-DDR3 (64*16*8)	SO2GBIII10	SO2GBIII10	N500GB 5.4KS
AS5820TG-434G50Mn	Ci5430M	MADISON_PRO	1G-DDR3 (64*16*8)	SO2GBIII10	SO2GBIII10	N500GB 5.4KS

Model	CPU	VGA Chip	VRAM 1	Memory 1	Memory 2	HDD 1(GB)
AS5820TG - 434G50Mn	Ci5430M	MADISON_PR O	1G-DDR3 (64*16*8)	SO2GBIII10	SO2GBIII10	N500GB 5.4KS
AS5820TG - 434G50Mn	Ci5430M	MADISON_PR O	1G-DDR3 (64*16*8)	SO2GBIII10	SO2GBIII10	N500GB 5.4KS
AS5820TG - 434G50Mn	Ci5430M	MADISON_PR O	1G-DDR3 (64*16*8)	SO2GBIII10	SO2GBIII10	N500GB 5.4KS
AS5820TG - 434G50Mn	Ci5430M	MADISON_PR O	1G-DDR3 (64*16*8)	SO2GBIII10	SO2GBIII10	N500GB 5.4KS
AS5820TG - 434G50Mn	Ci5430M	MADISON_PR O	1G-DDR3 (64*16*8)	SO2GBIII10	SO2GBIII10	N500GB 5.4KS
AS5820TG - 434G50Mn	Ci5430M	MADISON_PR O	1G-DDR3 (64*16*8)	SO2GBIII10	SO2GBIII10	N500GB 5.4KS
AS5820TG - 434G50Mn	Ci5430M	MADISON_PR O	1G-DDR3 (64*16*8)	SO2GBIII10	SO2GBIII10	N500GB 5.4KS
AS5820TG - 434G50Mn	Ci5430M	MADISON_PR O	1G-DDR3 (64*16*8)	SO2GBIII10	SO2GBIII10	N500GB 5.4KS
AS5820TG - 434G50Mn	Ci5430M	MADISON_PR O	1G-DDR3 (64*16*8)	SO2GBIII10	SO2GBIII10	N500GB 5.4KS
AS5820TG - 434G50Mn	Ci5430M	MADISON_PR O	1G-DDR3 (64*16*8)	SO2GBIII10	SO2GBIII10	N500GB 5.4KS
AS5820TG - 434G50Mn	Ci5430M	MADISON_PR O	1G-DDR3 (64*16*8)	SO2GBIII10	SO2GBIII10	N500GB 5.4KS
AS5820TG - 434G50Mn	Ci5430M	MADISON_PR O	1G-DDR3 (64*16*8)	SO2GBIII10	SO2GBIII10	N500GB 5.4KS
AS5820TG - 434G50Mn	Ci5430M	MADISON_PR O	1G-DDR3 (64*16*8)	SO2GBIII10	SO2GBIII10	N500GB 5.4KS
AS5820TG - 434G50Mn	Ci5430M	MADISON_PR O	1G-DDR3 (64*16*8)	SO2GBIII10	SO2GBIII10	N500GB 5.4KS
AS5820TG - 434G50Mn	Ci5430M	MADISON_PR O	1G-DDR3 (64*16*8)	SO2GBIII10	SO2GBIII10	N500GB 5.4KS
AS5820TG - 434G50Mn	Ci5430M	MADISON_PR O	1G-DDR3 (64*16*8)	SO2GBIII10	SO2GBIII10	N500GB 5.4KS

Model	CPU	VGA Chip	VRAM 1	Memory 1	Memory 2	HDD 1(GB)
AS5820TG - 434G50Mn	Ci5430M	MADISON_PR O	1G-DDR3 (64*16*8)	SO2GBIII10	SO2GBIII10	N500GB 5.4KS
AS5820TG - 434G50Mn	Ci5430M	MADISON_PR O	1G-DDR3 (64*16*8)	SO2GBIII10	SO2GBIII10	N500GB 5.4KS
AS5820TG - 434G50Mn	Ci5430M	MADISON_PR O	1G-DDR3 (64*16*8)	SO2GBIII10	SO2GBIII10	N500GB 5.4KS
AS5820TG - 434G50Mn	Ci5430M	MADISON_PR O	1G-DDR3 (64*16*8)	SO2GBIII10	SO2GBIII10	N500GB 5.4KS
AS5820TG - 434G50Mn	Ci5430M	MADISON_PR O	1G-DDR3 (64*16*8)	SO2GBIII10	SO2GBIII10	N500GB 5.4KS
AS5820TG - 434G50Mn	Ci5430M	MADISON_PR O	1G-DDR3 (64*16*8)	SO2GBIII10	SO2GBIII10	N500GB 5.4KS
AS5820TG - 434G50Mn	Ci5430M	MADISON_PR O	1G-DDR3 (64*16*8)	SO2GBIII10	SO2GBIII10	N500GB 5.4KS
AS5820TG - 434G50Mn	Ci5430M	MADISON_PR O	1G-DDR3 (64*16*8)	SO2GBIII10	SO2GBIII10	N500GB 5.4KS
AS5820TG - 434G50Mn	Ci5430M	MADISON_PR O	1G-DDR3 (64*16*8)	SO2GBIII10	SO2GBIII10	N500GB 5.4KS
AS5820TG - 434G50Mn	Ci5430M	MADISON_PR O	1G-DDR3 (64*16*8)	SO2GBIII10	SO2GBIII10	N500GB 5.4KS
AS5820TG - 434G50Mn	Ci5430M	MADISON_PR O	1G-DDR3 (64*16*8)	SO2GBIII10	SO2GBIII10	N500GB 5.4KS
AS5820TG - 434G50Mn	Ci5430M	MADISON_PR O	1G-DDR3 (64*16*8)	SO2GBIII10	SO2GBIII10	N500GB 5.4KS
AS5820TG - 434G50Mn	Ci5430M	MADISON_PR O	1G-DDR3 (64*16*8)	SO2GBIII10	SO2GBIII10	N500GB 5.4KS
AS5820TG - 434G50Mn	Ci5430M	MADISON_PR O	1G-DDR3 (64*16*8)	SO2GBIII10	SO2GBIII10	N500GB 5.4KS
AS5820TG - 434G50Mn	Ci5430M	MADISON_PR O	1G-DDR3 (64*16*8)	SO2GBIII10	SO2GBIII10	N500GB 5.4KS
AS5820TG - 434G50Mn	Ci5430M	MADISON_PR O	1G-DDR3 (64*16*8)	SO2GBIII10	SO2GBIII10	N500GB 5.4KS

Model	CPU	VGA Chip	VRAM 1	Memory 1	Memory 2	HDD 1(GB)
AS5820TG - 434G50Mn	Ci5430M	MADISON_PR O	1G-DDR3 (64*16*8)	SO2GBIII10	SO2GBIII10	N500GB 5.4KS
AS5820TG - 434G50Mn	Ci5430M	MADISON_PR O	1G-DDR3 (64*16*8)	SO2GBIII10	SO2GBIII10	N500GB 5.4KS
AS5820TG - 434G50Mn	Ci5430M	MADISON_PR O	1G-DDR3 (64*16*8)	SO2GBIII10	SO2GBIII10	N500GB 5.4KS
AS5820TG - 434G50Mn	Ci5430M	MADISON_PR O	1G-DDR3 (64*16*8)	SO2GBIII10	SO2GBIII10	N500GB 5.4KS
AS5820TG - 434G50Mn	Ci5430M	MADISON_PR O	1G-DDR3 (64*16*8)	SO2GBIII10	SO2GBIII10	N500GB 5.4KS
AS5820TG - 624G50Mn	Ci7620M	MADISON_PR O	1G-DDR3 (64*16*8)	SO2GBIII10	SO2GBIII10	N500GB 5.4KS
AS5820TG - 434G64Mn	Ci5430M	MADISON_PR O	1G-DDR3 (64*16*8)	SO2GBIII10	SO2GBIII10	N640GB 5.4KS
AS5820TG - 434G50Mn	Ci5430M	MADISON_PR O	1G-DDR3 (64*16*8)	SO2GBIII10	SO2GBIII10	N500GB 5.4KS
AS5820TG - 438G50Mn	Ci5430M	MADISON_PR O	1G-DDR3 (64*16*8)	SO4GBIII10	SO4GBIII10	N500GB 5.4KS
AS5820TG - 434G64Mn	Ci5430M	MADISON_PR O	1G-DDR3 (64*16*8)	SO2GBIII10	SO2GBIII10	N640GB 5.4KS
AS5820TG - 524G64Mn	Ci5520M	MADISON_PR O	1G-DDR3 (64*16*8)	SO2GBIII10	SO2GBIII10	N640GB 5.4KS
AS5820TG - 434G64Mn	Ci5430M	MADISON_PR O	1G-DDR3 (64*16*8)	SO2GBIII10	SO2GBIII10	N640GB 5.4KS
AS5820TG -434G64Mi	Ci5430M	MADISON_PR O	1G-DDR3 (64*16*8)	SO2GBIII10	SO2GBIII10	N640GB 5.4KS
AS5820TG - 624G64Mn	Ci7620M	MADISON_PR O	1G-DDR3 (64*16*8)	SO2GBIII10	SO2GBIII10	N640GB 5.4KS
AS5820TG - 434G50Mn	Ci5430M	MADISON_PR O	1G-DDR3 (64*16*8)	SO2GBIII10	SO2GBIII10	N500GB 5.4KS
AS5820TG - 624G64Mn	Ci7620M	MADISON_PR O	1G-DDR3 (64*16*8)	SO2GBIII10	SO2GBIII10	N640GB 5.4KS
AS5820TG - 626G64Mn	Ci7620M	MADISON_PR O	1G-DDR3 (64*16*8)	SO4GBIII10	SO2GBIII10	N640GB 5.4KS

Model	CPU	VGA Chip	VRAM 1	Memory 1	Memory 2	HDD 1(GB)
AS5820TG - 624G64Mn	Ci7620M	MADISON_PR O	1G-DDR3 (64*16*8)	SO2GBIII10	SO2GBIII10	N640GB 5.4KS
AS5820TG - 334G50Mn	Ci3330M	MADISON_PR O	1G-DDR3 (64*16*8)	SO2GBIII10	SO2GBIII10	N500GB 5.4KS
AS5820TG - 524G64Mn	Ci5520M	MADISON_PR O	1G-DDR3 (64*16*8)	SO2GBIII10	SO2GBIII10	N640GB 5.4KS
AS5820TG - 524G50Mn	Ci5520M	MADISON_PR O	1G-DDR3 (64*16*8)	SO2GBIII10	SO2GBIII10	N500GB 5.4KS
AS5820TG - 334G32Mn	Ci3330M	MADISON_PR O	1G-DDR3 (64*16*8)	SO2GBIII10	SO2GBIII10	N320GB 5.4KS
AS5820TG - 434G50Mn	Ci5430M	MADISON_PR O	1G-DDR3 (64*16*8)	SO2GBIII10	SO2GBIII10	N500GB 5.4KS
AS5820TG - 434G32Mn	Ci5430M	MADISON_PR O	1G-DDR3 (64*16*8)	SO2GBIII10	SO2GBIII10	N320GB 5.4KS
AS5820TG - 432G64Mn	Ci5430M	MADISON_PR O	1G-DDR3 (64*16*8)	SO2GBIII10	N	N640GB 5.4KS
AS5820TG - 432G50Mn	Ci5430M	MADISON_PR O	1G-DDR3 (64*16*8)	SO2GBIII10	N	N500GB 5.4KS
AS5820TG - 524G64Mn	Ci5520M	MADISON_PR O	1G-DDR3 (64*16*8)	SO2GBIII10	SO2GBIII10	N640GB 5.4KS
AS5820TG - 438G64Mn	Ci5430M	MADISON_PR O	1G-DDR3 (64*16*8)	SO4GBIII10	SO4GBIII10	N640GB 5.4KS
AS5820TG -438G64Mi	Ci5430M	MADISON_PR O	1G-DDR3 (64*16*8)	SO4GBIII10	SO4GBIII10	N640GB 5.4KS
AS5820TG - 438G64Mn	Ci5430M	MADISON_PR O	1G-DDR3 (64*16*8)	SO4GBIII10	SO4GBIII10	N640GB 5.4KS
AS5820TG - 438G64Mn	Ci5430M	MADISON_PR O	1G-DDR3 (64*16*8)	SO4GBIII10	SO4GBIII10	N640GB 5.4KS
AS5820TG - 438G64Mn	Ci5430M	MADISON_PR O	1G-DDR3 (64*16*8)	SO4GBIII10	SO4GBIII10	N640GB 5.4KS
AS5820TG - 438G64Mn	Ci5430M	MADISON_PR O	1G-DDR3 (64*16*8)	SO4GBIII10	SO4GBIII10	N640GB 5.4KS
AS5820TG - 438G64Mn	Ci5430M	MADISON_PR O	1G-DDR3 (64*16*8)	SO4GBIII10	SO4GBIII10	N640GB 5.4KS
AS5820TG - 438G64Mn	Ci5430M	MADISON_PR O	1G-DDR3 (64*16*8)	SO4GBIII10	SO4GBIII10	N640GB 5.4KS

Model	CPU	VGA Chip	VRAM 1	Memory 1	Memory 2	HDD 1(GB)
AS5820TG - 438G64Mn	Ci5430M	MADISON_PR O	1G-DDR3 (64*16*8)	SO4GBIII10	SO4GBIII10	N640GB 5.4KS
AS5820TG - 438G64Mn	Ci5430M	MADISON_PR O	1G-DDR3 (64*16*8)	SO4GBIII10	SO4GBIII10	N640GB 5.4KS
AS5820TG - 438G64Mn	Ci5430M	MADISON_PR O	1G-DDR3 (64*16*8)	SO4GBIII10	SO4GBIII10	N640GB 5.4KS
AS5820TG - 438G64Mn	Ci5430M	MADISON_PR O	1G-DDR3 (64*16*8)	SO4GBIII10	SO4GBIII10	N640GB 5.4KS
AS5820TG - 438G64Mn	Ci5430M	MADISON_PR O	1G-DDR3 (64*16*8)	SO4GBIII10	SO4GBIII10	N640GB 5.4KS
AS5820TG - 438G64Mn	Ci5430M	MADISON_PR O	1G-DDR3 (64*16*8)	SO4GBIII10	SO4GBIII10	N640GB 5.4KS
AS5820TG - 438G64Mn	Ci5430M	MADISON_PR O	1G-DDR3 (64*16*8)	SO4GBIII10	SO4GBIII10	N640GB 5.4KS
AS5820TG - 438G64Mn	Ci5430M	MADISON_PR O	1G-DDR3 (64*16*8)	SO4GBIII10	SO4GBIII10	N640GB 5.4KS
AS5820TG - 438G64Mn	Ci5430M	MADISON_PR O	1G-DDR3 (64*16*8)	SO4GBIII10	SO4GBIII10	N640GB 5.4KS
AS5820TG - 438G64Mn	Ci5430M	MADISON_PR O	1G-DDR3 (64*16*8)	SO4GBIII10	SO4GBIII10	N640GB 5.4KS
AS5820TG - 438G64Mn	Ci5430M	MADISON_PR O	1G-DDR3 (64*16*8)	SO4GBIII10	SO4GBIII10	N640GB 5.4KS
AS5820TG - 438G64Mn	Ci5430M	MADISON_PR O	1G-DDR3 (64*16*8)	SO4GBIII10	SO4GBIII10	N640GB 5.4KS
AS5820TG - 438G64Mn	Ci5430M	MADISON_PR O	1G-DDR3 (64*16*8)	SO4GBIII10	SO4GBIII10	N640GB 5.4KS
AS5820TG - 438G64Mn	Ci5430M	MADISON_PR O	1G-DDR3 (64*16*8)	SO4GBIII10	SO4GBIII10	N640GB 5.4KS
AS5820TG - 438G64Mn	Ci5430M	MADISON_PR O	1G-DDR3 (64*16*8)	SO4GBIII10	SO4GBIII10	N640GB 5.4KS
AS5820TG - 438G64Mn	Ci5430M	MADISON_PR O	1G-DDR3 (64*16*8)	SO4GBIII10	SO4GBIII10	N640GB 5.4KS

Model	CPU	VGA Chip	VRAM 1	Memory 1	Memory 2	HDD 1(GB)
AS5820TG - 438G64Mn	Ci5430M	MADISON_PR O	1G-DDR3 (64*16*8)	SO4GBIII10	SO4GBIII10	N640GB 5.4KS
AS5820TG - 438G64Mn	Ci5430M	MADISON_PR O	1G-DDR3 (64*16*8)	SO4GBIII10	SO4GBIII10	N640GB 5.4KS
AS5820TG - 438G64Mn	Ci5430M	MADISON_PR O	1G-DDR3 (64*16*8)	SO4GBIII10	SO4GBIII10	N640GB 5.4KS
AS5820TG - 438G64Mn	Ci5430M	MADISON_PR O	1G-DDR3 (64*16*8)	SO4GBIII10	SO4GBIII10	N640GB 5.4KS
AS5820TG - 438G64Mn	Ci5430M	MADISON_PR O	1G-DDR3 (64*16*8)	SO4GBIII10	SO4GBIII10	N640GB 5.4KS
AS5820TG - 438G64Mn	Ci5430M	MADISON_PR O	1G-DDR3 (64*16*8)	SO4GBIII10	SO4GBIII10	N640GB 5.4KS
AS5820TG - 438G64Mn	Ci5430M	MADISON_PR O	1G-DDR3 (64*16*8)	SO4GBIII10	SO4GBIII10	N640GB 5.4KS
AS5820TG - 438G64Mn	Ci5430M	MADISON_PR O	1G-DDR3 (64*16*8)	SO4GBIII10	SO4GBIII10	N640GB 5.4KS
AS5820TG - 438G64Mn	Ci5430M	MADISON_PR O	1G-DDR3 (64*16*8)	SO4GBIII10	SO4GBIII10	N640GB 5.4KS
AS5820TG - 438G64Mn	Ci5430M	MADISON_PR O	1G-DDR3 (64*16*8)	SO4GBIII10	SO4GBIII10	N640GB 5.4KS
AS5820TG - 438G64Mn	Ci5430M	MADISON_PR O	1G-DDR3 (64*16*8)	SO4GBIII10	SO4GBIII10	N640GB 5.4KS
AS5820TG - 438G64Mn	Ci5430M	MADISON_PR O	1G-DDR3 (64*16*8)	SO4GBIII10	SO4GBIII10	N640GB 5.4KS
AS5820TG - 438G64Mn	Ci5430M	MADISON_PR O	1G-DDR3 (64*16*8)	SO4GBIII10	SO4GBIII10	N640GB 5.4KS
AS5820TG - 438G64Mn	Ci5430M	MADISON_PR O	1G-DDR3 (64*16*8)	SO4GBIII10	SO4GBIII10	N640GB 5.4KS
AS5820TG - 438G64Mn	Ci5430M	MADISON_PR O	1G-DDR3 (64*16*8)	SO4GBIII10	SO4GBIII10	N640GB 5.4KS
AS5820TG - 438G64Mn	Ci5430M	MADISON_PR O	1G-DDR3 (64*16*8)	SO4GBIII10	SO4GBIII10	N640GB 5.4KS

Model	CPU	VGA Chip	VRAM 1	Memory 1	Memory 2	HDD 1(GB)
AS5820TG - 438G64Mn	Ci5430M	MADISON_PR O	1G-DDR3 (64*16*8)	SO4GBIII10	SO4GBIII10	N640GB 5.4KS
AS5820TG - 438G64Mn	Ci5430M	MADISON_PR O	1G-DDR3 (64*16*8)	SO4GBIII10	SO4GBIII10	N640GB 5.4KS
AS5820TG - 438G64Mn	Ci5430M	MADISON_PR O	1G-DDR3 (64*16*8)	SO4GBIII10	SO4GBIII10	N640GB 5.4KS
AS5820TG - 438G64Mn	Ci5430M	MADISON_PR O	1G-DDR3 (64*16*8)	SO4GBIII10	SO4GBIII10	N640GB 5.4KS
AS5820TG - 434G64Mn	Ci5430M	MADISON_PR O	1G-DDR3 (64*16*8)	SO2GBIII10	SO2GBIII10	N640GB 5.4KS
AS5820TG - 434G64Mn	Ci5430M	MADISON_PR O	1G-DDR3 (64*16*8)	SO2GBIII10	SO2GBIII10	N640GB 5.4KS
AS5820TG - 434G64Mn	Ci5430M	MADISON_PR O	1G-DDR3 (64*16*8)	SO2GBIII10	SO2GBIII10	N640GB 5.4KS
AS5820TG - 434G64Mn	Ci5430M	MADISON_PR O	1G-DDR3 (64*16*8)	SO2GBIII10	SO2GBIII10	N640GB 5.4KS
AS5820TG - 434G64Mn	Ci5430M	MADISON_PR O	1G-DDR3 (64*16*8)	SO2GBIII10	SO2GBIII10	N640GB 5.4KS
AS5820TG - 434G64Mn	Ci5430M	MADISON_PR O	1G-DDR3 (64*16*8)	SO2GBIII10	SO2GBIII10	N640GB 5.4KS
AS5820TG - 434G64Mn	Ci5430M	MADISON_PR O	1G-DDR3 (64*16*8)	SO2GBIII10	SO2GBIII10	N640GB 5.4KS
AS5820TG - 434G64Mn	Ci5430M	MADISON_PR O	1G-DDR3 (64*16*8)	SO2GBIII10	SO2GBIII10	N640GB 5.4KS
AS5820TG - 434G64Mn	Ci5430M	MADISON_PR O	1G-DDR3 (64*16*8)	SO2GBIII10	SO2GBIII10	N640GB 5.4KS
AS5820TG - 434G64Mn	Ci5430M	MADISON_PR O	1G-DDR3 (64*16*8)	SO2GBIII10	SO2GBIII10	N640GB 5.4KS
AS5820TG - 434G64Mn	Ci5430M	MADISON_PR O	1G-DDR3 (64*16*8)	SO2GBIII10	SO2GBIII10	N640GB 5.4KS
AS5820TG - 434G64Mn	Ci5430M	MADISON_PR O	1G-DDR3 (64*16*8)	SO2GBIII10	SO2GBIII10	N640GB 5.4KS

Model	CPU	VGA Chip	VRAM 1	Memory 1	Memory 2	HDD 1(GB)
AS5820TG - 434G64Mn	Ci5430M	MADISON_PR O	1G-DDR3 (64*16*8)	SO2GBIII10	SO2GBIII10	N640GB 5.4KS
AS5820TG - 434G64Mn	Ci5430M	MADISON_PR O	1G-DDR3 (64*16*8)	SO2GBIII10	SO2GBIII10	N640GB 5.4KS
AS5820TG - 434G64Mn	Ci5430M	MADISON_PR O	1G-DDR3 (64*16*8)	SO2GBIII10	SO2GBIII10	N640GB 5.4KS
AS5820TG - 434G64Mn	Ci5430M	MADISON_PR O	1G-DDR3 (64*16*8)	SO2GBIII10	SO2GBIII10	N640GB 5.4KS
AS5820TG - 434G64Mn	Ci5430M	MADISON_PR O	1G-DDR3 (64*16*8)	SO2GBIII10	SO2GBIII10	N640GB 5.4KS
AS5820TG - 434G64Mn	Ci5430M	MADISON_PR O	1G-DDR3 (64*16*8)	SO2GBIII10	SO2GBIII10	N640GB 5.4KS
AS5820TG - 434G64Mn	Ci5430M	MADISON_PR O	1G-DDR3 (64*16*8)	SO2GBIII10	SO2GBIII10	N640GB 5.4KS
AS5820TG - 434G64Mn	Ci5430M	MADISON_PR O	1G-DDR3 (64*16*8)	SO2GBIII10	SO2GBIII10	N640GB 5.4KS
AS5820TG - 434G64Mn	Ci5430M	MADISON_PR O	1G-DDR3 (64*16*8)	SO2GBIII10	SO2GBIII10	N640GB 5.4KS
AS5820TG - 434G64Mn	Ci5430M	MADISON_PR O	1G-DDR3 (64*16*8)	SO2GBIII10	SO2GBIII10	N640GB 5.4KS
AS5820TG - 434G64Mn	Ci5430M	MADISON_PR O	1G-DDR3 (64*16*8)	SO2GBIII10	SO2GBIII10	N640GB 5.4KS
AS5820TG - 434G64Mn	Ci5430M	MADISON_PR O	1G-DDR3 (64*16*8)	SO2GBIII10	SO2GBIII10	N640GB 5.4KS
AS5820TG - 434G64Mn	Ci5430M	MADISON_PR O	1G-DDR3 (64*16*8)	SO2GBIII10	SO2GBIII10	N640GB 5.4KS
AS5820TG - 434G64Mn	Ci5430M	MADISON_PR O	1G-DDR3 (64*16*8)	SO2GBIII10	SO2GBIII10	N640GB 5.4KS
AS5820TG - 434G64Mn	Ci5430M	MADISON_PR O	1G-DDR3 (64*16*8)	SO2GBIII10	SO2GBIII10	N640GB 5.4KS
AS5820TG - 434G64Mn	Ci5430M	MADISON_PR O	1G-DDR3 (64*16*8)	SO2GBIII10	SO2GBIII10	N640GB 5.4KS
AS5820TG - 434G64Mn	Ci5430M	MADISON_PR O	1G-DDR3 (64*16*8)	SO2GBIII10	SO2GBIII10	N640GB 5.4KS
AS5820TG - 434G64Mn	Ci5430M	MADISON_PR O	1G-DDR3 (64*16*8)	SO2GBIII10	SO2GBIII10	N640GB 5.4KS

Model	CPU	VGA Chip	VRAM 1	Memory 1	Memory 2	HDD 1(GB)
AS5820TG - 434G64Mn	Ci5430M	MADISON_PR O	1G-DDR3 (64*16*8)	SO2GBIII10	SO2GBIII10	N640GB 5.4KS
AS5820TG - 434G64Mn	Ci5430M	MADISON_PR O	1G-DDR3 (64*16*8)	SO2GBIII10	SO2GBIII10	N640GB 5.4KS
AS5820TG - 434G64Mn	Ci5430M	MADISON_PR O	1G-DDR3 (64*16*8)	SO2GBIII10	SO2GBIII10	N640GB 5.4KS
AS5820TG - 434G64Mn	Ci5430M	MADISON_PR O	1G-DDR3 (64*16*8)	SO2GBIII10	SO2GBIII10	N640GB 5.4KS
AS5820TG - 434G64Mn	Ci5430M	MADISON_PR O	1G-DDR3 (64*16*8)	SO2GBIII10	SO2GBIII10	N640GB 5.4KS
AS5820TG - 434G64Mn	Ci5430M	MADISON_PR O	1G-DDR3 (64*16*8)	SO2GBIII10	SO2GBIII10	N640GB 5.4KS
AS5820TG - 434G64Mn	Ci5430M	MADISON_PR O	1G-DDR3 (64*16*8)	SO2GBIII10	SO2GBIII10	N640GB 5.4KS
AS5820TG - 434G64Mn	Ci5430M	MADISON_PR O	1G-DDR3 (64*16*8)	SO2GBIII10	SO2GBIII10	N640GB 5.4KS
AS5820TG - 434G64Mn	Ci5430M	MADISON_PR O	1G-DDR3 (64*16*8)	SO2GBIII10	SO2GBIII10	N640GB 5.4KS
AS5820TG - 434G64Mn	Ci5430M	MADISON_PR O	1G-DDR3 (64*16*8)	SO2GBIII10	SO2GBIII10	N640GB 5.4KS
AS5820TG - 434G64Mn	Ci5430M	MADISON_PR O	1G-DDR3 (64*16*8)	SO2GBIII10	SO2GBIII10	N640GB 5.4KS
AS5820TG - 334G32Mn	Ci3330M	MADISON_PR O	1G-DDR3 (64*16*8)	SO2GBIII10	SO2GBIII10	N320GB 5.4KS
AS5820TG - 624G64Mn	Ci7620M	MADISON_PR O	1G-DDR3 (64*16*8)	SO2GBIII10	SO2GBIII10	N640GB 5.4KS
AS5820TG - 438G64Mn	Ci5430M	MADISON_PR O	1G-DDR3 (64*16*8)	SO4GBIII10	SO4GBIII10	N640GB 5.4KS
AS5820TG - 332G64Mn	Ci3330M	MADISON_PR O	1G-DDR3 (64*16*8)	SO2GBIII10	N	N640GB 5.4KS
AS5820TG - 522G64Mn	Ci5520M	MADISON_PR O	1G-DDR3 (64*16*8)	SO2GBIII10	N	N640GB 5.4KS
AS5820TG - 528G64Mn	Ci5520M	MADISON_PR O	1G-DDR3 (64*16*8)	SO4GBIII10	SO4GBIII10	N640GB 5.4KS

Model	CPU	VGA Chip	VRAM 1	Memory 1	Memory 2	HDD 1(GB)
AS5820TG - 524G32Mn	Ci5520M	MADISON_PR O	1G-DDR3 (64*16*8)	SO2GBIII10	SO2GBIII10	N320GB 5.4KS
AS5820TG - 334G50Mn	Ci3330M	PARK_XT	512M- DDR3 (64*16*4)	SO2GBIII10	SO2GBIII10	N500GB 5.4KS
AS5820TG - 334G50Mn	Ci3330M	PARK_XT	512M- DDR3 (64*16*4)	SO2GBIII10	SO2GBIII10	N500GB 5.4KS
AS5820TG - 434G32Mn	Ci5430M	PARK_XT	512M- DDR3 (64*16*4)	SO2GBIII10	SO2GBIII10	N320GB 5.4KS
AS5820TG -434G32Mi	Ci5430M	PARK_XT	512M- DDR3 (64*16*4)	SO2GBIII10	SO2GBIII10	N320GB 5.4KS
AS5820TG - 434G32Mn	Ci5430M	PARK_XT	512M- DDR3 (64*16*4)	SO2GBIII10	SO2GBIII10	N320GB 5.4KS
AS5820TG - 434G32Mn	Ci5430M	PARK_XT	512M- DDR3 (64*16*4)	SO2GBIII10	SO2GBIII10	N320GB 5.4KS
AS5820TG - 434G32Mn	Ci5430M	PARK_XT	512M- DDR3 (64*16*4)	SO2GBIII10	SO2GBIII10	N320GB 5.4KS
AS5820TG - 434G32Mn	Ci5430M	PARK_XT	512M- DDR3 (64*16*4)	SO2GBIII10	SO2GBIII10	N320GB 5.4KS
AS5820TG - 434G32Mn	Ci5430M	PARK_XT	512M- DDR3 (64*16*4)	SO2GBIII10	SO2GBIII10	N320GB 5.4KS
AS5820TG - 434G32Mn	Ci5430M	PARK_XT	512M- DDR3 (64*16*4)	SO2GBIII10	SO2GBIII10	N320GB 5.4KS
AS5820TG - 434G32Mn	Ci5430M	PARK_XT	512M- DDR3 (64*16*4)	SO2GBIII10	SO2GBIII10	N320GB 5.4KS
AS5820TG - 434G32Mn	Ci5430M	PARK_XT	512M- DDR3 (64*16*4)	SO2GBIII10	SO2GBIII10	N320GB 5.4KS
AS5820TG - 434G32Mn	Ci5430M	PARK_XT	512M- DDR3 (64*16*4)	SO2GBIII10	SO2GBIII10	N320GB 5.4KS
AS5820TG - 434G32Mn	Ci5430M	PARK_XT	512M- DDR3 (64*16*4)	SO2GBIII10	SO2GBIII10	N320GB 5.4KS
AS5820TG - 434G32Mn	Ci5430M	PARK_XT	512M- DDR3 (64*16*4)	SO2GBIII10	SO2GBIII10	N320GB 5.4KS
AS5820TG - 434G32Mn	Ci5430M	PARK_XT	512M- DDR3 (64*16*4)	SO2GBIII10	SO2GBIII10	N320GB 5.4KS
AS5820TG - 434G32Mn	Ci5430M	PARK_XT	512M- DDR3 (64*16*4)	SO2GBIII10	SO2GBIII10	N320GB 5.4KS

Model	CPU	VGA Chip	VRAM 1	Memory 1	Memory 2	HDD 1(GB)
AS5820TG - 434G32Mn	Ci5430M	PARK_XT	512M- DDR3 (64*16*4)	SO2GBIII10	SO2GBIII10	N320GB 5.4KS
AS5820TG - 434G32Mn	Ci5430M	PARK_XT	512M- DDR3 (64*16*4)	SO2GBIII10	SO2GBIII10	N320GB 5.4KS
AS5820TG - 434G32Mn	Ci5430M	PARK_XT	512M- DDR3 (64*16*4)	SO2GBIII10	SO2GBIII10	N320GB 5.4KS
AS5820TG - 434G32Mn	Ci5430M	PARK_XT	512M- DDR3 (64*16*4)	SO2GBIII10	SO2GBIII10	N320GB 5.4KS
AS5820TG - 434G32Mn	Ci5430M	PARK_XT	512M- DDR3 (64*16*4)	SO2GBIII10	SO2GBIII10	N320GB 5.4KS
AS5820TG - 434G32Mn	Ci5430M	PARK_XT	512M- DDR3 (64*16*4)	SO2GBIII10	SO2GBIII10	N320GB 5.4KS
AS5820TG - 434G32Mn	Ci5430M	PARK_XT	512M- DDR3 (64*16*4)	SO2GBIII10	SO2GBIII10	N320GB 5.4KS
AS5820TG - 434G32Mn	Ci5430M	PARK_XT	512M- DDR3 (64*16*4)	SO2GBIII10	SO2GBIII10	N320GB 5.4KS
AS5820TG - 434G32Mn	Ci5430M	PARK_XT	512M- DDR3 (64*16*4)	SO2GBIII10	SO2GBIII10	N320GB 5.4KS
AS5820TG - 434G32Mn	Ci5430M	PARK_XT	512M- DDR3 (64*16*4)	SO2GBIII10	SO2GBIII10	N320GB 5.4KS
AS5820TG - 434G32Mn	Ci5430M	PARK_XT	512M- DDR3 (64*16*4)	SO2GBIII10	SO2GBIII10	N320GB 5.4KS
AS5820TG - 434G32Mn	Ci5430M	PARK_XT	512M- DDR3 (64*16*4)	SO2GBIII10	SO2GBIII10	N320GB 5.4KS
AS5820TG - 434G32Mn	Ci5430M	PARK_XT	512M- DDR3 (64*16*4)	SO2GBIII10	SO2GBIII10	N320GB 5.4KS
AS5820TG - 434G32Mn	Ci5430M	PARK_XT	512M- DDR3 (64*16*4)	SO2GBIII10	SO2GBIII10	N320GB 5.4KS
AS5820TG - 434G32Mn	Ci5430M	PARK_XT	512M- DDR3 (64*16*4)	SO2GBIII10	SO2GBIII10	N320GB 5.4KS
AS5820TG - 434G32Mn	Ci5430M	PARK_XT	512M- DDR3 (64*16*4)	SO2GBIII10	SO2GBIII10	N320GB 5.4KS
AS5820TG - 434G32Mn	Ci5430M	PARK_XT	512M- DDR3 (64*16*4)	SO2GBIII10	SO2GBIII10	N320GB 5.4KS

Model	CPU	VGA Chip	VRAM 1	Memory 1	Memory 2	HDD 1(GB)
AS5820TG - 434G32Mn	Ci5430M	PARK_XT	512M- DDR3 (64*16*4)	SO2GBIII10	SO2GBIII10	N320GB 5.4KS
AS5820TG - 434G32Mn	Ci5430M	PARK_XT	512M- DDR3 (64*16*4)	SO2GBIII10	SO2GBIII10	N320GB 5.4KS
AS5820TG - 434G32Mn	Ci5430M	PARK_XT	512M- DDR3 (64*16*4)	SO2GBIII10	SO2GBIII10	N320GB 5.4KS
AS5820TG - 434G32Mn	Ci5430M	PARK_XT	512M- DDR3 (64*16*4)	SO2GBIII10	SO2GBIII10	N320GB 5.4KS
AS5820TG - 434G32Mn	Ci5430M	PARK_XT	512M- DDR3 (64*16*4)	SO2GBIII10	SO2GBIII10	N320GB 5.4KS
AS5820TG - 434G32Mn	Ci5430M	PARK_XT	512M- DDR3 (64*16*4)	SO2GBIII10	SO2GBIII10	N320GB 5.4KS
AS5820TG - 434G32Mn	Ci5430M	PARK_XT	512M- DDR3 (64*16*4)	SO2GBIII10	SO2GBIII10	N320GB 5.4KS
AS5820TG - 434G32Mn	Ci5430M	PARK_XT	512M- DDR3 (64*16*4)	SO2GBIII10	SO2GBIII10	N320GB 5.4KS
AS5820TG - 434G32Mn	Ci5430M	PARK_XT	512M- DDR3 (64*16*4)	SO2GBIII10	SO2GBIII10	N320GB 5.4KS
AS5820TG - 434G32Mn	Ci5430M	PARK_XT	512M- DDR3 (64*16*4)	SO2GBIII10	SO2GBIII10	N320GB 5.4KS
AS5820TG - 434G32Mn	Ci5430M	PARK_XT	512M- DDR3 (64*16*4)	SO2GBIII10	SO2GBIII10	N320GB 5.4KS
AS5820TG - 434G32Mn	Ci5430M	PARK_XT	512M- DDR3 (64*16*4)	SO2GBIII10	SO2GBIII10	N320GB 5.4KS
AS5820TG - 434G32Mn	Ci5430M	PARK_XT	512M- DDR3 (64*16*4)	SO2GBIII10	SO2GBIII10	N320GB 5.4KS
AS5820TG - 434G32Mn	Ci5430M	PARK_XT	512M- DDR3 (64*16*4)	SO2GBIII10	SO2GBIII10	N320GB 5.4KS
AS5820TG - 434G50Mn	Ci5430M	PARK_XT	512M- DDR3 (64*16*4)	SO2GBIII10	SO2GBIII10	N500GB 5.4KS
AS5820TG - 434G50Mn	Ci5430M	PARK_XT	512M- DDR3 (64*16*4)	SO2GBIII10	SO2GBIII10	N500GB 5.4KS

Model	CPU	VGA Chip	VRAM 1	Memory 1	Memory 2	HDD 1(GB)
AS5820TG - 334G32Mn	Ci3330M	PARK_XT	512M- DDR3 (64*16*4)	SO2GBIII10	SO2GBIII10	N320GB 5.4KS
AS5820TG - 334G50Mn	Ci3330M	PARK_XT	512M- DDR3 (64*16*4)	SO2GBIII10	SO2GBIII10	N500GB 5.4KS
AS5820TG - 432G50Mn	Ci5430M	PARK_XT	512M- DDR3 (64*16*4)	SO2GBIII10	N	N500GB 5.4KS
AS5820TG - 434G50Mn	Ci5430M	PARK_XT	512M- DDR3 (64*16*4)	SO2GBIII10	SO2GBIII10	N500GB 5.4KS
AS5820TG - 334G50Mn	Ci3330M	PARK_XT	512M- DDR3 (64*16*4)	SO2GBIII10	SO2GBIII10	N500GB 5.4KS
AS5820TG - 332G32Mn	Ci3330M	PARK_XT	512M- DDR3 (64*16*4)	SO2GBIII10	N	N320GB 5.4KS
AS5820TG - 333G50Mn	Ci3330M	PARK_XT	512M- DDR3 (64*16*4)	SO2GBIII10	SO1GBIII10	N500GB 5.4KS
AS5820TG - 434G64Mn	Ci5430M	PARK_XT	512M- DDR3 (64*16*4)	SO2GBIII10	SO2GBIII10	N640GB 5.4KS
AS5820TG - 434G32Mn	Ci5430M	PARK_XT	512M- DDR3 (64*16*4)	SO2GBIII10	SO2GBIII10	N320GB 5.4KS
AS5820TG - 434G50Mn	Ci5430M	PARK_XT	512M- DDR3 (64*16*4)	SO2GBIII10	SO2GBIII10	N500GB 5.4KS
AS5820TG - 334G50Mn	Ci3330M	PARK_XT	512M- DDR3 (64*16*4)	SO2GBIII10	SO2GBIII10	N500GB 5.4KS
AS5820TG - 334G32Mn	Ci3330M	PARK_XT	512M- DDR3 (64*16*4)	SO2GBIII10	SO2GBIII10	N320GB 5.4KS
AS5820TG - 333G50Mn	Ci3330M	PARK_XT	512M- DDR3 (64*16*4)	SO2GBIII10	SO1GBIII10	N500GB 5.4KS
AS5820TG - 434G50Mn	Ci5430M	PARK_XT	512M- DDR3 (64*16*4)	SO2GBIII10	SO2GBIII10	N500GB 5.4KS
AS5820TG - 434G50Mi	Ci5430M	PARK_XT	512M- DDR3 (64*16*4)	SO2GBIII10	SO2GBIII10	N500GB 5.4KS
AS5820TG - 434G50Mn	Ci5430M	PARK_XT	512M- DDR3 (64*16*4)	SO2GBIII10	SO2GBIII10	N500GB 5.4KS
AS5820TG - 434G50Mn	Ci5430M	PARK_XT	512M- DDR3 (64*16*4)	SO2GBIII10	SO2GBIII10	N500GB 5.4KS

Model	CPU	VGA Chip	VRAM 1	Memory 1	Memory 2	HDD 1(GB)
AS5820TG - 434G50Mn	Ci5430M	PARK_XT	512M- DDR3 (64*16*4)	SO2GBIII10	SO2GBIII10	N500GB 5.4KS
AS5820TG - 434G50Mn	Ci5430M	PARK_XT	512M- DDR3 (64*16*4)	SO2GBIII10	SO2GBIII10	N500GB 5.4KS
AS5820TG - 434G50Mn	Ci5430M	PARK_XT	512M- DDR3 (64*16*4)	SO2GBIII10	SO2GBIII10	N500GB 5.4KS
AS5820TG - 434G50Mn	Ci5430M	PARK_XT	512M- DDR3 (64*16*4)	SO2GBIII10	SO2GBIII10	N500GB 5.4KS
AS5820TG - 434G50Mn	Ci5430M	PARK_XT	512M- DDR3 (64*16*4)	SO2GBIII10	SO2GBIII10	N500GB 5.4KS
AS5820TG - 434G50Mn	Ci5430M	PARK_XT	512M- DDR3 (64*16*4)	SO2GBIII10	SO2GBIII10	N500GB 5.4KS
AS5820TG - 434G50Mn	Ci5430M	PARK_XT	512M- DDR3 (64*16*4)	SO2GBIII10	SO2GBIII10	N500GB 5.4KS
AS5820TG - 434G50Mn	Ci5430M	PARK_XT	512M- DDR3 (64*16*4)	SO2GBIII10	SO2GBIII10	N500GB 5.4KS
AS5820TG - 434G50Mn	Ci5430M	PARK_XT	512M- DDR3 (64*16*4)	SO2GBIII10	SO2GBIII10	N500GB 5.4KS
AS5820TG - 434G50Mn	Ci5430M	PARK_XT	512M- DDR3 (64*16*4)	SO2GBIII10	SO2GBIII10	N500GB 5.4KS
AS5820TG - 434G50Mn	Ci5430M	PARK_XT	512M- DDR3 (64*16*4)	SO2GBIII10	SO2GBIII10	N500GB 5.4KS
AS5820TG - 434G50Mn	Ci5430M	PARK_XT	512M- DDR3 (64*16*4)	SO2GBIII10	SO2GBIII10	N500GB 5.4KS
AS5820TG - 434G50Mn	Ci5430M	PARK_XT	512M- DDR3 (64*16*4)	SO2GBIII10	SO2GBIII10	N500GB 5.4KS
AS5820TG - 434G50Mn	Ci5430M	PARK_XT	512M- DDR3 (64*16*4)	SO2GBIII10	SO2GBIII10	N500GB 5.4KS
AS5820TG - 434G50Mn	Ci5430M	PARK_XT	512M- DDR3 (64*16*4)	SO2GBIII10	SO2GBIII10	N500GB 5.4KS
AS5820TG - 434G50Mn	Ci5430M	PARK_XT	512M- DDR3 (64*16*4)	SO2GBIII10	SO2GBIII10	N500GB 5.4KS
AS5820TG - 434G50Mn	Ci5430M	PARK_XT	512M- DDR3 (64*16*4)	SO2GBIII10	SO2GBIII10	N500GB 5.4KS

Model	CPU	VGA Chip	VRAM 1	Memory 1	Memory 2	HDD 1(GB)
AS5820TG - 434G50Mn	Ci5430M	PARK_XT	512M- DDR3 (64*16*4)	SO2GBIII10	SO2GBIII10	N500GB 5.4KS
AS5820TG - 434G50Mn	Ci5430M	PARK_XT	512M- DDR3 (64*16*4)	SO2GBIII10	SO2GBIII10	N500GB 5.4KS
AS5820TG - 434G50Mn	Ci5430M	PARK_XT	512M- DDR3 (64*16*4)	SO2GBIII10	SO2GBIII10	N500GB 5.4KS
AS5820TG - 434G50Mn	Ci5430M	PARK_XT	512M- DDR3 (64*16*4)	SO2GBIII10	SO2GBIII10	N500GB 5.4KS
AS5820TG - 434G50Mn	Ci5430M	PARK_XT	512M- DDR3 (64*16*4)	SO2GBIII10	SO2GBIII10	N500GB 5.4KS
AS5820TG - 434G50Mn	Ci5430M	PARK_XT	512M- DDR3 (64*16*4)	SO2GBIII10	SO2GBIII10	N500GB 5.4KS
AS5820TG - 434G50Mn	Ci5430M	PARK_XT	512M- DDR3 (64*16*4)	SO2GBIII10	SO2GBIII10	N500GB 5.4KS
AS5820TG - 434G50Mn	Ci5430M	PARK_XT	512M- DDR3 (64*16*4)	SO2GBIII10	SO2GBIII10	N500GB 5.4KS
AS5820TG - 434G50Mn	Ci5430M	PARK_XT	512M- DDR3 (64*16*4)	SO2GBIII10	SO2GBIII10	N500GB 5.4KS
AS5820TG - 434G50Mn	Ci5430M	PARK_XT	512M- DDR3 (64*16*4)	SO2GBIII10	SO2GBIII10	N500GB 5.4KS
AS5820TG - 434G50Mn	Ci5430M	PARK_XT	512M- DDR3 (64*16*4)	SO2GBIII10	SO2GBIII10	N500GB 5.4KS
AS5820TG - 434G50Mn	Ci5430M	PARK_XT	512M- DDR3 (64*16*4)	SO2GBIII10	SO2GBIII10	N500GB 5.4KS
AS5820TG - 434G50Mn	Ci5430M	PARK_XT	512M- DDR3 (64*16*4)	SO2GBIII10	SO2GBIII10	N500GB 5.4KS
AS5820TG - 434G50Mn	Ci5430M	PARK_XT	512M- DDR3 (64*16*4)	SO2GBIII10	SO2GBIII10	N500GB 5.4KS
AS5820TG - 434G50Mn	Ci5430M	PARK_XT	512M- DDR3 (64*16*4)	SO2GBIII10	SO2GBIII10	N500GB 5.4KS
AS5820TG - 434G50Mn	Ci5430M	PARK_XT	512M- DDR3 (64*16*4)	SO2GBIII10	SO2GBIII10	N500GB 5.4KS
AS5820TG - 434G50Mn	Ci5430M	PARK_XT	512M- DDR3 (64*16*4)	SO2GBIII10	SO2GBIII10	N500GB 5.4KS
AS5820TG - 434G50Mn	Ci5430M	PARK_XT	512M- DDR3 (64*16*4)	SO2GBIII10	SO2GBIII10	N500GB 5.4KS

Model	CPU	VGA Chip	VRAM 1	Memory 1	Memory 2	HDD 1(GB)
AS5820TG - 434G50Mn	Ci5430M	PARK_XT	512M- DDR3 (64*16*4)	SO2GBIII10	SO2GBIII10	N500GB 5.4KS
AS5820TG - 434G50Mn	Ci5430M	PARK_XT	512M- DDR3 (64*16*4)	SO2GBIII10	SO2GBIII10	N500GB 5.4KS
AS5820TG - 434G50Mn	Ci5430M	PARK_XT	512M- DDR3 (64*16*4)	SO2GBIII10	SO2GBIII10	N500GB 5.4KS
AS5820TG - 434G50Mn	Ci5430M	PARK_XT	512M- DDR3 (64*16*4)	SO2GBIII10	SO2GBIII10	N500GB 5.4KS
AS5820TG - 434G50Mn	Ci5430M	PARK_XT	512M- DDR3 (64*16*4)	SO2GBIII10	SO2GBIII10	N500GB 5.4KS
AS5820TG - 434G32Mn	Ci5430M	PARK_XT	512M- DDR3 (64*16*4)	SO2GBIII10	SO2GBIII10	N320GB 5.4KS
AS5820TG - 524G50Mn	Ci5520M	PARK_XT	512M- DDR3 (64*16*4)	SO2GBIII10	SO2GBIII10	N500GB 5.4KS
AS5820TG - 524G50Mn	Ci5520M	PARK_XT	512M- DDR3 (64*16*4)	SO2GBIII10	SO2GBIII10	N500GB 5.4KS
AS5820TG - 434G25Mn	Ci5430M	PARK_XT	512M- DDR3 (64*16*4)	SO2GBIII10	SO2GBIII10	N250GB 5.4KS
AS5820TG - 522G50Mn	Ci5520M	PARK_XT	512M- DDR3 (64*16*4)	SO1GBIII10	SO1GBIII10	N500GB 5.4KS
AS5820TG - 524G25Mn	Ci5520M	PARK_XT	512M- DDR3 (64*16*4)	SO2GBIII10	SO2GBIII10	N250GB 5.4KS
AS5820T- 334G32Mn	Ci3330M	UMA	N	SO2GBIII10	SO2GBIII10	N320GB 5.4KS
AS5820T- 333G32Mn	Ci3330M	UMA	N	SO2GBIII10	SO1GBIII10	N320GB 5.4KS
AS5820T- 333G32Mi	Ci3330M	UMA	N	SO2GBIII10	SO1GBIII10	N320GB 5.4KS
AS5820T- 333G32Mn	Ci3330M	UMA	N	SO2GBIII10	SO1GBIII10	N320GB 5.4KS
AS5820T- 333G32Mn	Ci3330M	UMA	N	SO2GBIII10	SO1GBIII10	N320GB 5.4KS
AS5820T- 333G32Mn	Ci3330M	UMA	N	SO2GBIII10	SO1GBIII10	N320GB 5.4KS
AS5820T- 333G32Mn	Ci3330M	UMA	N	SO2GBIII10	SO1GBIII10	N320GB 5.4KS
AS5820T- 333G32Mn	Ci3330M	UMA	N	SO2GBIII10	SO1GBIII10	N320GB 5.4KS
AS5820T- 333G32Mn	Ci3330M	UMA	N	SO2GBIII10	SO1GBIII10	N320GB 5.4KS

Model	CPU	VGA Chip	VRAM 1	Memory 1	Memory 2	HDD 1(GB)
AS5820T-333G32Mn	Ci3330M	UMA	N	SO2GBIII10	SO1GBIII10	N320GB 5.4KS
AS5820T-333G32Mn	Ci3330M	UMA	N	SO2GBIII10	SO1GBIII10	N320GB 5.4KS
AS5820T-333G32Mn	Ci3330M	UMA	N	SO2GBIII10	SO1GBIII10	N320GB 5.4KS
AS5820T-333G32Mn	Ci3330M	UMA	N	SO2GBIII10	SO1GBIII10	N320GB 5.4KS
AS5820T-333G32Mn	Ci3330M	UMA	N	SO2GBIII10	SO1GBIII10	N320GB 5.4KS
AS5820T-333G32Mn	Ci3330M	UMA	N	SO2GBIII10	SO1GBIII10	N320GB 5.4KS
AS5820T-333G32Mn	Ci3330M	UMA	N	SO2GBIII10	SO1GBIII10	N320GB 5.4KS
AS5820T-333G32Mn	Ci3330M	UMA	N	SO2GBIII10	SO1GBIII10	N320GB 5.4KS
AS5820T-333G32Mn	Ci3330M	UMA	N	SO2GBIII10	SO1GBIII10	N320GB 5.4KS
AS5820T-333G32Mn	Ci3330M	UMA	N	SO2GBIII10	SO1GBIII10	N320GB 5.4KS
AS5820T-333G32Mn	Ci3330M	UMA	N	SO2GBIII10	SO1GBIII10	N320GB 5.4KS
AS5820T-333G32Mn	Ci3330M	UMA	N	SO2GBIII10	SO1GBIII10	N320GB 5.4KS
AS5820T-333G32Mn	Ci3330M	UMA	N	SO2GBIII10	SO1GBIII10	N320GB 5.4KS
AS5820T-334G32Mn	Ci3330M	UMA	N	SO2GBIII10	SO2GBIII10	N320GB 5.4KS
AS5820T-334G50Mn	Ci3330M	UMA	N	SO2GBIII10	SO2GBIII10	N500GB 5.4KS
AS5820T-434G50Mn	Ci5430M	UMA	N	SO2GBIII10	SO2GBIII10	N500GB 5.4KS
AS5820T-434G32Mn	Ci5430M	UMA	N	SO2GBIII10	SO2GBIII10	N320GB 5.4KS
AS5820T-334G50Mn	Ci3330M	UMA	N	SO2GBIII10	SO2GBIII10	N500GB 5.4KS
AS5820T-334G32Mn	Ci3330M	UMA	N	SO2GBIII10	SO2GBIII10	N320GB 5.4KS
AS5820T-334G32Mn	Ci3330M	UMA	N	SO2GBIII10	SO2GBIII10	N320GB 5.4KS
AS5820T-334G32Mi	Ci3330M	UMA	N	SO2GBIII10	SO2GBIII10	N320GB 5.4KS
AS5820T-334G32Mn	Ci3330M	UMA	N	SO2GBIII10	SO2GBIII10	N320GB 5.4KS
AS5820T-334G32Mn	Ci3330M	UMA	N	SO2GBIII10	SO2GBIII10	N320GB 5.4KS

Model	CPU	VGA Chip	VRAM 1	Memory 1	Memory 2	HDD 1(GB)
AS5820T-334G32Mn	Ci3330M	UMA	N	SO2GBIII10	SO2GBIII10	N320GB 5.4KS
AS5820T-334G32Mn	Ci3330M	UMA	N	SO2GBIII10	SO2GBIII10	N320GB 5.4KS
AS5820T-334G32Mn	Ci3330M	UMA	N	SO2GBIII10	SO2GBIII10	N320GB 5.4KS
AS5820T-334G32Mn	Ci3330M	UMA	N	SO2GBIII10	SO2GBIII10	N320GB 5.4KS
AS5820T-334G32Mn	Ci3330M	UMA	N	SO2GBIII10	SO2GBIII10	N320GB 5.4KS
AS5820T-334G32Mn	Ci3330M	UMA	N	SO2GBIII10	SO2GBIII10	N320GB 5.4KS
AS5820T-334G32Mn	Ci3330M	UMA	N	SO2GBIII10	SO2GBIII10	N320GB 5.4KS
AS5820T-334G32Mn	Ci3330M	UMA	N	SO2GBIII10	SO2GBIII10	N320GB 5.4KS
AS5820T-334G32Mn	Ci3330M	UMA	N	SO2GBIII10	SO2GBIII10	N320GB 5.4KS
AS5820T-334G32Mn	Ci3330M	UMA	N	SO2GBIII10	SO2GBIII10	N320GB 5.4KS
AS5820T-334G32Mn	Ci3330M	UMA	N	SO2GBIII10	SO2GBIII10	N320GB 5.4KS
AS5820T-334G32Mn	Ci3330M	UMA	N	SO2GBIII10	SO2GBIII10	N320GB 5.4KS
AS5820T-334G32Mn	Ci3330M	UMA	N	SO2GBIII10	SO2GBIII10	N320GB 5.4KS
AS5820T-334G32Mn	Ci3330M	UMA	N	SO2GBIII10	SO2GBIII10	N320GB 5.4KS
AS5820T-334G32Mn	Ci3330M	UMA	N	SO2GBIII10	SO2GBIII10	N320GB 5.4KS
AS5820T-334G32Mn	Ci3330M	UMA	N	SO2GBIII10	SO2GBIII10	N320GB 5.4KS
AS5820T-334G32Mn	Ci3330M	UMA	N	SO2GBIII10	SO2GBIII10	N320GB 5.4KS
AS5820T-334G32Mn	Ci3330M	UMA	N	SO2GBIII10	SO2GBIII10	N320GB 5.4KS
AS5820T-334G32Mn	Ci3330M	UMA	N	SO2GBIII10	SO2GBIII10	N320GB 5.4KS
AS5820T-432G32Mn	Ci5430M	UMA	N	SO2GBIII10	N	N320GB 5.4KS
AS5820T-434G50Mn	Ci5430M	UMA	N	SO2GBIII10	SO2GBIII10	N500GB 5.4KS
AS5820T-333G32Mn	Ci3330M	UMA	N	SO2GBIII10	SO1GBIII10	N320GB 5.4KS
AS5820T-332G16Mn	Ci3330M	UMA	N	SO1GBIII10	SO1GBIII10	N160GB 5.4KS
AS5820T-522G16Mn	Ci5520M	UMA	N	SO1GBIII10	SO1GBIII10	N160GB 5.4KS
AS5820T-524G16Mn	Ci5520M	UMA	N	SO2GBIII10	SO2GBIII10	N160GB 5.4KS

Model	Wireless LAN1	Bluetooth	Battery	Adapter	K/B
AS5820TG - 434G50Mn	3rd WiFi 2x2 BGN	BT 2.1	6CELL3.0	90W	German (KB.I170A.155)

Model	Wireless LAN1	Bluetooth	Battery	Adapter	K/B
AS5820TG - 434G50Mn	3rd WiFi 2x2 BGN	BT 2.1	6CELL3.0	90W	US International (KB.I170A.172)
AS5820TG - 434G50Mn	3rd WiFi 2x2 BGN	BT 2.1	6CELL3.0	90W	US International (KB.I170A.172)
AS5820TG - 434G50Mn	3rd WiFi 2x2 BGN	N	6CELL3.0	90W	Russian (KB.I170A.164)
AS5820TG -434G50Mi	3rd WiFi BG	N	6CELL3.0	90W	Russian (KB.I170A.164)
AS5820TG - 434G50Mn	3rd WiFi 2x2 BGN	N	6CELL3.0	90W	Russian (KB.I170A.164)
AS5820TG - 434G50Mn	3rd WiFi 2x2 BGN	N	6CELL3.0	90W	Arabic (KB.I170A.147)
AS5820TG - 434G50Mn	3rd WiFi 2x2 BGN	N	6CELL3.0	90W	US International (KB.I170A.172)
AS5820TG - 434G50Mn	3rd WiFi 2x2 BGN	N	6CELL3.0	90W	Turkish (KB.I170A.170)
AS5820TG - 434G50Mn	3rd WiFi 2x2 BGN	N	6CELL3.0	90W	Arabic (KB.I170A.147)
AS5820TG - 434G50Mn	3rd WiFi 2x2 BGN	N	6CELL3.0	90W	Arabic (KB.I170A.147)
AS5820TG - 434G50Mn	3rd WiFi 2x2 BGN	N	6CELL3.0	90W	US International (KB.I170A.172)
AS5820TG - 434G50Mn	3rd WiFi 2x2 BGN	N	6CELL3.0	90W	FR/Arabic (KB.I170A.153)
AS5820TG - 434G50Mn	3rd WiFi 2x2 BGN	N	6CELL3.0	90W	FR/Arabic (KB.I170A.153)
AS5820TG - 434G50Mn	3rd WiFi 2x2 BGN	N	6CELL3.0	90W	French (KB.I170A.154)
AS5820TG - 434G50Mn	3rd WiFi 2x2 BGN	N	6CELL3.0	90W	Russian (KB.I170A.164)
AS5820TG - 434G50Mn	3rd WiFi 2x2 BGN	N	6CELL3.0	90W	Arabic (KB.I170A.147)
AS5820TG - 434G50Mn	3rd WiFi 2x2 BGN	N	6CELL3.0	90W	French (KB.I170A.154)

Model	Wireless LAN1	Bluetooth	Battery	Adapter	K/B
AS5820TG - 434G50Mn	3rd WiFi 2x2 BGN	N	6CELL3.0	90W	US International (KB.I170A.172)
AS5820TG - 434G50Mn	3rd WiFi 2x2 BGN	N	6CELL3.0	90W	US International (KB.I170A.172)
AS5820TG - 434G50Mn	3rd WiFi 2x2 BGN	N	6CELL3.0	90W	German (KB.I170A.155)
AS5820TG - 434G50Mn	3rd WiFi 2x2 BGN	N	6CELL3.0	90W	US International (KB.I170A.172)
AS5820TG - 434G50Mn	3rd WiFi 2x2 BGN	N	6CELL3.0	90W	US International (KB.I170A.172)
AS5820TG - 434G50Mn	3rd WiFi 2x2 BGN	N	6CELL3.0	90W	US International (KB.I170A.172)
AS5820TG - 434G50Mn	3rd WiFi 2x2 BGN	N	6CELL3.0	90W	Belgium (KB.I170A.148)
AS5820TG - 434G50Mn	3rd WiFi 2x2 BGN	N	6CELL3.0	90W	Swiss/G (KB.I170A.168)
AS5820TG - 434G50Mn	3rd WiFi 2x2 BGN	N	6CELL3.0	90W	Swiss/G (KB.I170A.168)
AS5820TG - 434G50Mn	3rd WiFi 2x2 BGN	N	6CELL3.0	90W	Russian (KB.I170A.164)
AS5820TG - 434G50Mn	3rd WiFi 2x2 BGN	N	6CELL3.0	90W	Russian (KB.I170A.164)
AS5820TG - 434G50Mn	3rd WiFi 2x2 BGN	N	6CELL3.0	90W	UK (KB.I170A.171)
AS5820TG - 434G50Mn	3rd WiFi 2x2 BGN	N	6CELL3.0	90W	US International (KB.I170A.172)
AS5820TG - 434G50Mn	3rd WiFi 2x2 BGN	N	6CELL3.0	90W	US International (KB.I170A.172)
AS5820TG - 434G50Mn	3rd WiFi 2x2 BGN	N	6CELL3.0	90W	CZ/SK (KB.I170A.150)
AS5820TG - 434G50Mn	3rd WiFi 2x2 BGN	N	6CELL3.0	90W	Hungarian (KB.I170A.157)
AS5820TG - 434G50Mn	3rd WiFi 2x2 BGN	N	6CELL3.0	90W	US International w/ Hebrew (KB.I170A.173)

Model	Wireless LAN1	Bluetooth	Battery	Adapter	K/B
AS5820TG - 434G50Mn	3rd WiFi 2x2 BGN	N	6CELL3.0	90W	Russian (KB.I170A.164)
AS5820TG - 434G50Mn	3rd WiFi 2x2 BGN	N	6CELL3.0	90W	Portuguese (KB.I170A.163)
AS5820TG - 434G50Mn	3rd WiFi 2x2 BGN	N	6CELL3.0	90W	UK (KB.I170A.171)
AS5820TG - 434G50Mn	3rd WiFi 2x2 BGN	N	6CELL3.0	90W	Sweden (KB.I170A.167)
AS5820TG - 434G50Mn	3rd WiFi 2x2 BGN	N	6CELL3.0	90W	SLO/CRO (KB.I170A.165)
AS5820TG - 434G50Mn	3rd WiFi 2x2 BGN	N	6CELL3.0	90W	Italian (KB.I170A.158)
AS5820TG - 434G50Mn	3rd WiFi 2x2 BGN	N	6CELL3.0	90W	SLO/CRO (KB.I170A.165)
AS5820TG - 434G50Mn	3rd WiFi 2x2 BGN	N	6CELL3.0	90W	German (KB.I170A.155)
AS5820TG - 434G50Mn	3rd WiFi 2x2 BGN	N	6CELL3.0	90W	Spanish (KB.I170A.166)
AS5820TG - 434G50Mn	3rd WiFi 2x2 BGN	N	6CELL3.0	90W	Nordic (KB.I170A.161)
AS5820TG - 434G50Mn	3rd WiFi 2x2 BGN	N	6CELL3.0	90W	SLO/CRO (KB.I170A.165)
AS5820TG - 434G50Mn	3rd WiFi 2x2 BGN	N	6CELL3.0	90W	Sweden (KB.I170A.167)
AS5820TG - 434G50Mn	3rd WiFi 2x2 BGN	N	6CELL3.0	90W	Greek (KB.I170A.156)
AS5820TG - 624G50Mn	3rd WiFi 2x2 BGN	BT 2.1	6CELL3.0	90W	US International (KB.I170A.172)
AS5820TG - 434G64Mn	3rd WiFi 2x2 BGN	BT 2.1	9CELL3.0	90W	Arabic (KB.I170A.147)
AS5820TG - 434G50Mn	3rd WiFi 2x2 BGN	N	6CELL3.0	90W	French (KB.I170A.154)
AS5820TG - 438G50Mn	INT1000H	BT 2.1	6CELL3.0	90W	US International (KB.I170A.172)

Model	Wireless LAN1	Bluetooth	Battery	Adapter	K/B
AS5820TG - 434G64Mn	3rd WiFi 2x2 BGN	BT 2.1	6CELL3.0	90W	Spanish (KB.I170A.166)
AS5820TG - 524G64Mn	3rd WiFi 2x2 BGN	BT 2.1	6CELL3.0	90W	German (KB.I170A.155)
AS5820TG - 434G64Mn	3rd WiFi 2x2 BGN	BT 2.1	6CELL3.0	90W	Nordic (KB.I170A.161)
AS5820TG -434G64Mi	3rd WiFi BG	BT 2.1	6CELL3.0	90W	Russian (KB.I170A.164)
AS5820TG - 624G64Mn	3rd WiFi 2x2 BGN	BT 2.1	6CELL3.0	90W	Swiss/G (KB.I170A.168)
AS5820TG - 434G50Mn	3rd WiFi 2x2 BGN	BT 2.1	6CELL3.0	90W	Swiss/G (KB.I170A.168)
AS5820TG - 624G64Mn	3rd WiFi 2x2 BGN	BT 2.1	9CELL3.0	90W	Spanish (KB.I170A.166)
AS5820TG - 626G64Mn	3rd WiFi 2x2 BGN	BT 2.1	6CELL3.0	90W	Spanish (KB.I170A.166)
AS5820TG - 624G64Mn	3rd WiFi 2x2 BGN	BT 2.1	6CELL3.0	90W	US International (KB.I170A.172)
AS5820TG - 334G50Mn	3rd WiFi 2x2 BGN	N	6CELL3.0	90W	US International (KB.I170A.172)
AS5820TG - 524G64Mn	3rd WiFi 2x2 BGN	BT 2.1	6CELL3.0	90W	US International (KB.I170A.172)
AS5820TG - 524G50Mn	3rd WiFi 2x2 BGN	BT 2.1	6CELL3.0	90W	US International (KB.I170A.172)
AS5820TG - 334G32Mn	3rd WiFi 2x2 BGN	N	6CELL3.0	90W	US International (KB.I170A.172)
AS5820TG - 434G50Mn	3rd WiFi 2x2 BGN	BT 2.1	6CELL3.0	90W	US International (KB.I170A.172)
AS5820TG - 434G32Mn	3rd WiFi 2x2 BGN	BT 2.1	6CELL3.0	90W	US International (KB.I170A.172)
AS5820TG - 432G64Mn	3rd WiFi 2x2 BGN	BT 2.1	6CELL3.0	90W	Chinese (KB.I170A.151)
AS5820TG - 432G50Mn	3rd WiFi 2x2 BGN	BT 2.1	6CELL3.0	90W	Chinese (KB.I170A.151)

Model	Wireless LAN1	Bluetooth	Battery	Adapter	K/B
AS5820TG - 524G64Mn	3rd WiFi 2x2 BGN	BT 2.1	6CELL3.0	90W	Chinese (KB.I170A.151)
AS5820TG - 438G64Mn	3rd WiFi 2x2 BGN	BT 2.1	9CELL3.0	90W	Russian (KB.I170A.164)
AS5820TG -438G64Mi	3rd WiFi BG	BT 2.1	9CELL3.0	90W	Russian (KB.I170A.164)
AS5820TG - 438G64Mn	3rd WiFi 2x2 BGN	BT 2.1	9CELL3.0	90W	Russian (KB.I170A.164)
AS5820TG - 438G64Mn	3rd WiFi 2x2 BGN	BT 2.1	9CELL3.0	90W	Arabic (KB.I170A.147)
AS5820TG - 438G64Mn	3rd WiFi 2x2 BGN	BT 2.1	9CELL3.0	90W	US International (KB.I170A.172)
AS5820TG - 438G64Mn	3rd WiFi 2x2 BGN	BT 2.1	9CELL3.0	90W	Turkish (KB.I170A.170)
AS5820TG - 438G64Mn	3rd WiFi 2x2 BGN	BT 2.1	9CELL3.0	90W	Arabic (KB.I170A.147)
AS5820TG - 438G64Mn	3rd WiFi 2x2 BGN	BT 2.1	9CELL3.0	90W	Arabic (KB.I170A.147)
AS5820TG - 438G64Mn	3rd WiFi 2x2 BGN	BT 2.1	9CELL3.0	90W	FR/Arabic (KB.I170A.153)
AS5820TG - 438G64Mn	3rd WiFi 2x2 BGN	BT 2.1	9CELL3.0	90W	FR/Arabic (KB.I170A.153)
AS5820TG - 438G64Mn	3rd WiFi 2x2 BGN	BT 2.1	9CELL3.0	90W	French (KB.I170A.154)
AS5820TG - 438G64Mn	3rd WiFi 2x2 BGN	BT 2.1	9CELL3.0	90W	Russian (KB.I170A.164)
AS5820TG - 438G64Mn	3rd WiFi 2x2 BGN	BT 2.1	9CELL3.0	90W	Arabic (KB.I170A.147)
AS5820TG - 438G64Mn	3rd WiFi 2x2 BGN	BT 2.1	9CELL3.0	90W	French (KB.I170A.154)
AS5820TG - 438G64Mn	3rd WiFi 2x2 BGN	BT 2.1	9CELL3.0	90W	US International (KB.I170A.172)
AS5820TG - 438G64Mn	3rd WiFi 2x2 BGN	BT 2.1	9CELL3.0	90W	US International (KB.I170A.172)

Model	Wireless LAN1	Bluetooth	Battery	Adapter	K/B
AS5820TG - 438G64Mn	3rd WiFi 2x2 BGN	BT 2.1	9CELL3.0	90W	US International (KB.I170A.172)
AS5820TG - 438G64Mn	3rd WiFi 2x2 BGN	BT 2.1	9CELL3.0	90W	German (KB.I170A.155)
AS5820TG - 438G64Mn	3rd WiFi 2x2 BGN	BT 2.1	9CELL3.0	90W	US International (KB.I170A.172)
AS5820TG - 438G64Mn	3rd WiFi 2x2 BGN	BT 2.1	9CELL3.0	90W	Swiss/G (KB.I170A.168)
AS5820TG - 438G64Mn	3rd WiFi 2x2 BGN	BT 2.1	9CELL3.0	90W	US International (KB.I170A.172)
AS5820TG - 438G64Mn	3rd WiFi 2x2 BGN	BT 2.1	9CELL3.0	90W	Belgium (KB.I170A.148)
AS5820TG - 438G64Mn	3rd WiFi 2x2 BGN	BT 2.1	9CELL3.0	90W	Swiss/G (KB.I170A.168)
AS5820TG - 438G64Mn	3rd WiFi 2x2 BGN	BT 2.1	9CELL3.0	90W	Russian (KB.I170A.164)
AS5820TG - 438G64Mn	3rd WiFi 2x2 BGN	BT 2.1	9CELL3.0	90W	Russian (KB.I170A.164)
AS5820TG - 438G64Mn	3rd WiFi 2x2 BGN	BT 2.1	9CELL3.0	90W	US International (KB.I170A.172)
AS5820TG - 438G64Mn	3rd WiFi 2x2 BGN	BT 2.1	9CELL3.0	90W	US International (KB.I170A.172)
AS5820TG - 438G64Mn	3rd WiFi 2x2 BGN	BT 2.1	9CELL3.0	90W	UK (KB.I170A.171)
AS5820TG - 438G64Mn	3rd WiFi 2x2 BGN	BT 2.1	9CELL3.0	90W	CZ/SK (KB.I170A.150)
AS5820TG - 438G64Mn	3rd WiFi 2x2 BGN	BT 2.1	9CELL3.0	90W	Hungarian (KB.I170A.157)
AS5820TG - 438G64Mn	3rd WiFi 2x2 BGN	BT 2.1	9CELL3.0	90W	US International w/ Hebrew (KB.I170A.173)
AS5820TG - 438G64Mn	3rd WiFi 2x2 BGN	BT 2.1	9CELL3.0	90W	Russian (KB.I170A.164)
AS5820TG - 438G64Mn	3rd WiFi 2x2 BGN	BT 2.1	9CELL3.0	90W	UK (KB.I170A.171)

Model	Wireless LAN1	Bluetooth	Battery	Adapter	K/B
AS5820TG - 438G64Mn	3rd WiFi 2x2 BGN	BT 2.1	9CELL3.0	90W	Portuguese (KB.I170A.163)
AS5820TG - 438G64Mn	3rd WiFi 2x2 BGN	BT 2.1	9CELL3.0	90W	Sweden (KB.I170A.167)
AS5820TG - 438G64Mn	3rd WiFi 2x2 BGN	BT 2.1	9CELL3.0	90W	SLO/CRO (KB.I170A.165)
AS5820TG - 438G64Mn	3rd WiFi 2x2 BGN	BT 2.1	9CELL3.0	90W	Nordic (KB.I170A.161)
AS5820TG - 438G64Mn	3rd WiFi 2x2 BGN	BT 2.1	9CELL3.0	90W	SLO/CRO (KB.I170A.165)
AS5820TG - 438G64Mn	3rd WiFi 2x2 BGN	BT 2.1	9CELL3.0	90W	Sweden (KB.I170A.167)
AS5820TG - 438G64Mn	3rd WiFi 2x2 BGN	BT 2.1	9CELL3.0	90W	Italian (KB.I170A.158)
AS5820TG - 438G64Mn	3rd WiFi 2x2 BGN	BT 2.1	9CELL3.0	90W	Spanish (KB.I170A.166)
AS5820TG - 438G64Mn	3rd WiFi 2x2 BGN	BT 2.1	9CELL3.0	90W	Greek (KB.I170A.156)
AS5820TG - 438G64Mn	3rd WiFi 2x2 BGN	BT 2.1	9CELL3.0	90W	German (KB.I170A.155)
AS5820TG - 438G64Mn	3rd WiFi 2x2 BGN	BT 2.1	9CELL3.0	90W	SLO/CRO (KB.I170A.165)
AS5820TG - 438G64Mn	3rd WiFi 2x2 BGN	BT 2.1	9CELL3.0	90W	French (KB.I170A.154)
AS5820TG - 434G64Mn	3rd WiFi 2x2 BGN	BT 2.1	6CELL3.0	90W	Russian (KB.I170A.164)
AS5820TG - 434G64Mn	3rd WiFi 2x2 BGN	BT 2.1	6CELL3.0	90W	Arabic (KB.I170A.147)
AS5820TG - 434G64Mn	3rd WiFi 2x2 BGN	BT 2.1	6CELL3.0	90W	US International (KB.I170A.172)
AS5820TG - 434G64Mn	3rd WiFi 2x2 BGN	BT 2.1	6CELL3.0	90W	Turkish (KB.I170A.170)
AS5820TG - 434G64Mn	3rd WiFi 2x2 BGN	BT 2.1	6CELL3.0	90W	Arabic (KB.I170A.147)

Model	Wireless LAN1	Bluetooth	Battery	Adapter	K/B
AS5820TG - 434G64Mn	3rd WiFi 2x2 BGN	BT 2.1	6CELL3.0	90W	Arabic (KB.I170A.147)
AS5820TG - 434G64Mn	3rd WiFi 2x2 BGN	BT 2.1	6CELL3.0	90W	FR/Arabic (KB.I170A.153)
AS5820TG - 434G64Mn	3rd WiFi 2x2 BGN	BT 2.1	6CELL3.0	90W	FR/Arabic (KB.I170A.153)
AS5820TG - 434G64Mn	3rd WiFi 2x2 BGN	BT 2.1	6CELL3.0	90W	Russian (KB.I170A.164)
AS5820TG - 434G64Mn	3rd WiFi 2x2 BGN	BT 2.1	6CELL3.0	90W	French (KB.I170A.154)
AS5820TG - 434G64Mn	3rd WiFi 2x2 BGN	BT 2.1	6CELL3.0	90W	Russian (KB.I170A.164)
AS5820TG - 434G64Mn	3rd WiFi 2x2 BGN	BT 2.1	6CELL3.0	90W	Arabic (KB.I170A.147)
AS5820TG - 434G64Mn	3rd WiFi 2x2 BGN	BT 2.1	6CELL3.0	90W	French (KB.I170A.154)
AS5820TG - 434G64Mn	3rd WiFi 2x2 BGN	BT 2.1	6CELL3.0	90W	US International (KB.I170A.172)
AS5820TG - 434G64Mn	3rd WiFi 2x2 BGN	BT 2.1	6CELL3.0	90W	US International (KB.I170A.172)
AS5820TG - 434G64Mn	3rd WiFi 2x2 BGN	BT 2.1	6CELL3.0	90W	US International (KB.I170A.172)
AS5820TG - 434G64Mn	3rd WiFi 2x2 BGN	BT 2.1	6CELL3.0	90W	German (KB.I170A.155)
AS5820TG - 434G64Mn	3rd WiFi 2x2 BGN	BT 2.1	6CELL3.0	90W	US International (KB.I170A.172)
AS5820TG - 434G64Mn	3rd WiFi 2x2 BGN	BT 2.1	6CELL3.0	90W	Swiss/G (KB.I170A.168)
AS5820TG - 434G64Mn	3rd WiFi 2x2 BGN	BT 2.1	6CELL3.0	90W	US International (KB.I170A.172)
AS5820TG - 434G64Mn	3rd WiFi 2x2 BGN	BT 2.1	6CELL3.0	90W	Belgium (KB.I170A.148)
AS5820TG - 434G64Mn	3rd WiFi 2x2 BGN	BT 2.1	6CELL3.0	90W	Swiss/G (KB.I170A.168)

Model	Wireless LAN1	Bluetooth	Battery	Adapter	K/B
AS5820TG - 434G64Mn	3rd WiFi 2x2 BGN	BT 2.1	6CELL3.0	90W	Russian (KB.I170A.164)
AS5820TG - 434G64Mn	3rd WiFi 2x2 BGN	BT 2.1	6CELL3.0	90W	US International (KB.I170A.172)
AS5820TG - 434G64Mn	3rd WiFi 2x2 BGN	BT 2.1	6CELL3.0	90W	US International (KB.I170A.172)
AS5820TG - 434G64Mn	3rd WiFi 2x2 BGN	BT 2.1	6CELL3.0	90W	UK (KB.I170A.171)
AS5820TG - 434G64Mn	3rd WiFi 2x2 BGN	BT 2.1	6CELL3.0	90W	CZ/SK (KB.I170A.150)
AS5820TG - 434G64Mn	3rd WiFi 2x2 BGN	BT 2.1	6CELL3.0	90W	Hungarian (KB.I170A.157)
AS5820TG - 434G64Mn	3rd WiFi 2x2 BGN	BT 2.1	6CELL3.0	90W	US International w/ Hebrew (KB.I170A.173)
AS5820TG - 434G64Mn	3rd WiFi 2x2 BGN	BT 2.1	6CELL3.0	90W	UK (KB.I170A.171)
AS5820TG - 434G64Mn	3rd WiFi 2x2 BGN	BT 2.1	6CELL3.0	90W	Sweden (KB.I170A.167)
AS5820TG - 434G64Mn	3rd WiFi 2x2 BGN	BT 2.1	6CELL3.0	90W	Portuguese (KB.I170A.163)
AS5820TG - 434G64Mn	3rd WiFi 2x2 BGN	BT 2.1	6CELL3.0	90W	SLO/CRO (KB.I170A.165)
AS5820TG - 434G64Mn	3rd WiFi 2x2 BGN	BT 2.1	6CELL3.0	90W	SLO/CRO (KB.I170A.165)
AS5820TG - 434G64Mn	3rd WiFi 2x2 BGN	BT 2.1	6CELL3.0	90W	Sweden (KB.I170A.167)
AS5820TG - 434G64Mn	3rd WiFi 2x2 BGN	BT 2.1	6CELL3.0	90W	Italian (KB.I170A.158)
AS5820TG - 434G64Mn	3rd WiFi 2x2 BGN	BT 2.1	6CELL3.0	90W	Russian (KB.I170A.164)
AS5820TG - 434G64Mn	3rd WiFi 2x2 BGN	BT 2.1	6CELL3.0	90W	Greek (KB.I170A.156)
AS5820TG - 434G64Mn	3rd WiFi 2x2 BGN	BT 2.1	6CELL3.0	90W	German (KB.I170A.155)

Model	Wireless LAN1	Bluetooth	Battery	Adapter	K/B
AS5820TG - 434G64Mn	3rd WiFi 2x2 BGN	BT 2.1	6CELL3.0	90W	SLO/CRO (KB.I170A.165)
AS5820TG - 434G64Mn	3rd WiFi 2x2 BGN	BT 2.1	6CELL3.0	90W	French (KB.I170A.154)
AS5820TG - 334G32Mn	INT1000H	BT 2.1	6CELL3.0	90W	US International (KB.I170A.172)
AS5820TG - 624G64Mn	3rd WiFi 2x2 BGN	BT 2.1	9CELL3.0	90W	UK (KB.I170A.171)
AS5820TG - 438G64Mn	3rd WiFi 2x2 BGN	BT 2.1	6CELL3.0	90W	US International (KB.I170A.172)
AS5820TG - 332G64Mn	3rd WiFi 2x2 BGN	BT 2.1	6CELL3.0	90W	Chinese (KB.I170A.151)
AS5820TG - 522G64Mn	3rd WiFi 2x2 BGN	BT 2.1	6CELL3.0	90W	Chinese (KB.I170A.151)
AS5820TG - 528G64Mn	3rd WiFi 2x2 BGN	BT 2.1	6CELL3.0	90W	US International (KB.I170A.172)
AS5820TG - 524G32Mn	3rd WiFi 2x2 BGN	BT 2.1	6CELL3.0	90W	US International (KB.I170A.172)
AS5820TG - 334G50Mn	3rd WiFi 2x2 BGN	BT 2.1	6CELL3.0	90W	German (KB.I170A.155)
AS5820TG - 334G50Mn	3rd WiFi 2x2 BGN	BT 2.1	6CELL3.0	90W	Arabic (KB.I170A.147)
AS5820TG - 434G32Mn	3rd WiFi 2x2 BGN	BT 2.1	6CELL3.0	90W	Russian (KB.I170A.164)
AS5820TG -434G32Mi	3rd WiFi BG	BT 2.1	6CELL3.0	90W	Russian (KB.I170A.164)
AS5820TG - 434G32Mn	3rd WiFi 2x2 BGN	BT 2.1	6CELL3.0	90W	Russian (KB.I170A.164)
AS5820TG - 434G32Mn	3rd WiFi 2x2 BGN	BT 2.1	6CELL3.0	90W	Arabic (KB.I170A.147)
AS5820TG - 434G32Mn	3rd WiFi 2x2 BGN	BT 2.1	6CELL3.0	90W	US International (KB.I170A.172)
AS5820TG - 434G32Mn	3rd WiFi 2x2 BGN	BT 2.1	6CELL3.0	90W	Turkish (KB.I170A.170)

Model	Wireless LAN1	Bluetooth	Battery	Adapter	K/B
AS5820TG - 434G32Mn	3rd WiFi 2x2 BGN	BT 2.1	6CELL3.0	90W	Arabic (KB.I170A.147)
AS5820TG - 434G32Mn	3rd WiFi 2x2 BGN	BT 2.1	6CELL3.0	90W	Arabic (KB.I170A.147)
AS5820TG - 434G32Mn	3rd WiFi 2x2 BGN	BT 2.1	6CELL3.0	90W	US International (KB.I170A.172)
AS5820TG - 434G32Mn	3rd WiFi 2x2 BGN	BT 2.1	6CELL3.0	90W	FR/Arabic (KB.I170A.153)
AS5820TG - 434G32Mn	3rd WiFi 2x2 BGN	BT 2.1	6CELL3.0	90W	FR/Arabic (KB.I170A.153)
AS5820TG - 434G32Mn	3rd WiFi 2x2 BGN	BT 2.1	6CELL3.0	90W	French (KB.I170A.154)
AS5820TG - 434G32Mn	3rd WiFi 2x2 BGN	BT 2.1	6CELL3.0	90W	Russian (KB.I170A.164)
AS5820TG - 434G32Mn	3rd WiFi 2x2 BGN	BT 2.1	6CELL3.0	90W	Arabic (KB.I170A.147)
AS5820TG - 434G32Mn	3rd WiFi 2x2 BGN	BT 2.1	6CELL3.0	90W	French (KB.I170A.154)
AS5820TG - 434G32Mn	3rd WiFi 2x2 BGN	BT 2.1	6CELL3.0	90W	US International (KB.I170A.172)
AS5820TG - 434G32Mn	3rd WiFi 2x2 BGN	BT 2.1	6CELL3.0	90W	US International (KB.I170A.172)
AS5820TG - 434G32Mn	3rd WiFi 2x2 BGN	BT 2.1	6CELL3.0	90W	German (KB.I170A.155)
AS5820TG - 434G32Mn	3rd WiFi 2x2 BGN	BT 2.1	6CELL3.0	90W	US International (KB.I170A.172)
AS5820TG - 434G32Mn	3rd WiFi 2x2 BGN	BT 2.1	6CELL3.0	90W	US International (KB.I170A.172)
AS5820TG - 434G32Mn	3rd WiFi 2x2 BGN	BT 2.1	6CELL3.0	90W	US International (KB.I170A.172)
AS5820TG - 434G32Mn	3rd WiFi 2x2 BGN	BT 2.1	6CELL3.0	90W	Belgium (KB.I170A.148)
AS5820TG - 434G32Mn	3rd WiFi 2x2 BGN	BT 2.1	6CELL3.0	90W	Swiss/G (KB.I170A.168)

Model	Wireless LAN1	Bluetooth	Battery	Adapter	K/B
AS5820TG - 434G32Mn	3rd WiFi 2x2 BGN	BT 2.1	6CELL3.0	90W	Swiss/G (KB.I170A.168)
AS5820TG - 434G32Mn	3rd WiFi 2x2 BGN	BT 2.1	6CELL3.0	90W	Russian (KB.I170A.164)
AS5820TG - 434G32Mn	3rd WiFi 2x2 BGN	BT 2.1	6CELL3.0	90W	Russian (KB.I170A.164)
AS5820TG - 434G32Mn	3rd WiFi 2x2 BGN	BT 2.1	6CELL3.0	90W	UK (KB.I170A.171)
AS5820TG - 434G32Mn	3rd WiFi 2x2 BGN	BT 2.1	6CELL3.0	90W	US International (KB.I170A.172)
AS5820TG - 434G32Mn	3rd WiFi 2x2 BGN	BT 2.1	6CELL3.0	90W	US International (KB.I170A.172)
AS5820TG - 434G32Mn	3rd WiFi 2x2 BGN	BT 2.1	6CELL3.0	90W	CZ/SK (KB.I170A.150)
AS5820TG - 434G32Mn	3rd WiFi 2x2 BGN	BT 2.1	6CELL3.0	90W	Hungarian (KB.I170A.157)
AS5820TG - 434G32Mn	3rd WiFi 2x2 BGN	BT 2.1	6CELL3.0	90W	US International w/ Hebrew (KB.I170A.173)
AS5820TG - 434G32Mn	3rd WiFi 2x2 BGN	BT 2.1	6CELL3.0	90W	Russian (KB.I170A.164)
AS5820TG - 434G32Mn	3rd WiFi 2x2 BGN	BT 2.1	6CELL3.0	90W	Portuguese (KB.I170A.163)
AS5820TG - 434G32Mn	3rd WiFi 2x2 BGN	BT 2.1	6CELL3.0	90W	UK (KB.I170A.171)
AS5820TG - 434G32Mn	3rd WiFi 2x2 BGN	BT 2.1	6CELL3.0	90W	SLO/CRO (KB.I170A.165)
AS5820TG - 434G32Mn	3rd WiFi 2x2 BGN	BT 2.1	6CELL3.0	90W	Sweden (KB.I170A.167)
AS5820TG - 434G32Mn	3rd WiFi 2x2 BGN	BT 2.1	6CELL3.0	90W	Italian (KB.I170A.158)
AS5820TG - 434G32Mn	3rd WiFi 2x2 BGN	BT 2.1	6CELL3.0	90W	Spanish (KB.I170A.166)
AS5820TG - 434G32Mn	3rd WiFi 2x2 BGN	BT 2.1	6CELL3.0	90W	Nordic (KB.I170A.161)

Model	Wireless LAN1	Bluetooth	Battery	Adapter	K/B
AS5820TG - 434G32Mn	3rd WiFi 2x2 BGN	BT 2.1	6CELL3.0	90W	SLO/CRO (KB.I170A.165)
AS5820TG - 434G32Mn	3rd WiFi 2x2 BGN	BT 2.1	6CELL3.0	90W	Sweden (KB.I170A.167)
AS5820TG - 434G32Mn	3rd WiFi 2x2 BGN	BT 2.1	6CELL3.0	90W	Greek (KB.I170A.156)
AS5820TG - 434G32Mn	3rd WiFi 2x2 BGN	BT 2.1	6CELL3.0	90W	German (KB.I170A.155)
AS5820TG - 434G32Mn	3rd WiFi 2x2 BGN	BT 2.1	6CELL3.0	90W	French (KB.I170A.154)
AS5820TG - 434G32Mn	3rd WiFi 2x2 BGN	BT 2.1	6CELL3.0	90W	SLO/CRO (KB.I170A.165)
AS5820TG - 434G50Mn	3rd WiFi 2x2 BGN	BT 2.1	6CELL3.0	90W	US International (KB.I170A.172)
AS5820TG - 434G50Mn	3rd WiFi 2x2 BGN	N	9CELL3.0	90W	UK (KB.I170A.171)
AS5820TG - 334G32Mn	3rd WiFi 2x2 BGN	N	6CELL3.0	90W	French (KB.I170A.154)
AS5820TG - 334G50Mn	3rd WiFi 2x2 BGN	BT 2.1	6CELL3.0	90W	Spanish (KB.I170A.166)
AS5820TG - 432G50Mn	3rd WiFi 2x2 BGN	BT 2.1	6CELL3.0	90W	Chinese (KB.I170A.151)
AS5820TG - 434G50Mn	3rd WiFi 2x2 BGN	BT 2.1	6CELL3.0	90W	Nordic (KB.I170A.161)
AS5820TG - 334G50Mn	3rd WiFi 2x2 BGN	N	6CELL3.0	90W	Greek (KB.I170A.156)
AS5820TG - 332G32Mn	3rd WiFi 2x2 BGN	BT 2.1	6CELL3.0	90W	US International (KB.I170A.172)
AS5820TG - 333G50Mn	3rd WiFi 2x2 BGN	BT 2.1	6CELL3.0	90W	US International (KB.I170A.172)
AS5820TG - 434G64Mn	3rd WiFi 2x2 BGN	BT 2.1	6CELL3.0	90W	Spanish (KB.I170A.166)
AS5820TG - 434G32Mn	3rd WiFi 2x2 BGN	BT 2.1	6CELL3.0	90W	US International (KB.I170A.172)

Model	Wireless LAN1	Bluetooth	Battery	Adapter	K/B
AS5820TG - 434G50Mn	3rd WiFi 2x2 BGN	BT 2.1	6CELL3.0	90W	US International (KB.I170A.172)
AS5820TG - 334G50Mn	3rd WiFi 2x2 BGN	N	6CELL3.0	90W	US International (KB.I170A.172)
AS5820TG - 334G32Mn	3rd WiFi 2x2 BGN	N	6CELL3.0	90W	US International (KB.I170A.172)
AS5820TG - 333G50Mn	3rd WiFi 2x2 BGN	N	6CELL3.0	90W	Italian (KB.I170A.158)
AS5820TG - 434G50Mn	3rd WiFi 2x2 BGN	BT 2.1	6CELL3.0	90W	Russian (KB.I170A.164)
AS5820TG -434G50Mi	3rd WiFi BG	BT 2.1	6CELL3.0	90W	Russian (KB.I170A.164)
AS5820TG - 434G50Mn	3rd WiFi 2x2 BGN	BT 2.1	6CELL3.0	90W	Russian (KB.I170A.164)
AS5820TG - 434G50Mn	3rd WiFi 2x2 BGN	BT 2.1	6CELL3.0	90W	Russian (KB.I170A.164)
AS5820TG - 434G50Mn	3rd WiFi 2x2 BGN	BT 2.1	6CELL3.0	90W	Arabic (KB.I170A.147)
AS5820TG - 434G50Mn	3rd WiFi 2x2 BGN	BT 2.1	6CELL3.0	90W	French (KB.I170A.154)
AS5820TG - 434G50Mn	3rd WiFi 2x2 BGN	BT 2.1	6CELL3.0	90W	US International (KB.I170A.172)
AS5820TG - 434G50Mn	3rd WiFi 2x2 BGN	BT 2.1	6CELL3.0	90W	US International (KB.I170A.172)
AS5820TG - 434G50Mn	3rd WiFi 2x2 BGN	BT 2.1	6CELL3.0	90W	US International (KB.I170A.172)
AS5820TG - 434G50Mn	3rd WiFi 2x2 BGN	BT 2.1	6CELL3.0	90W	German (KB.I170A.155)
AS5820TG - 434G50Mn	3rd WiFi 2x2 BGN	BT 2.1	6CELL3.0	90W	Arabic (KB.I170A.147)
AS5820TG - 434G50Mn	3rd WiFi 2x2 BGN	BT 2.1	6CELL3.0	90W	US International (KB.I170A.172)
AS5820TG - 434G50Mn	3rd WiFi 2x2 BGN	BT 2.1	6CELL3.0	90W	Turkish (KB.I170A.170)

Model	Wireless LAN1	Bluetooth	Battery	Adapter	K/B
AS5820TG - 434G50Mn	3rd WiFi 2x2 BGN	BT 2.1	6CELL3.0	90W	Arabic (KB.I170A.147)
AS5820TG - 434G50Mn	3rd WiFi 2x2 BGN	BT 2.1	6CELL3.0	90W	Arabic (KB.I170A.147)
AS5820TG - 434G50Mn	3rd WiFi 2x2 BGN	BT 2.1	6CELL3.0	90W	FR/Arabic (KB.I170A.153)
AS5820TG - 434G50Mn	3rd WiFi 2x2 BGN	BT 2.1	6CELL3.0	90W	FR/Arabic (KB.I170A.153)
AS5820TG - 434G50Mn	3rd WiFi 2x2 BGN	BT 2.1	6CELL3.0	90W	French (KB.I170A.154)
AS5820TG - 434G50Mn	3rd WiFi 2x2 BGN	BT 2.1	6CELL3.0	90W	US International (KB.I170A.172)
AS5820TG - 434G50Mn	3rd WiFi 2x2 BGN	BT 2.1	6CELL3.0	90W	Swiss/G (KB.I170A.168)
AS5820TG - 434G50Mn	3rd WiFi 2x2 BGN	BT 2.1	6CELL3.0	90W	US International (KB.I170A.172)
AS5820TG - 434G50Mn	3rd WiFi 2x2 BGN	BT 2.1	6CELL3.0	90W	Belgium (KB.I170A.148)
AS5820TG - 434G50Mn	3rd WiFi 2x2 BGN	BT 2.1	6CELL3.0	90W	Swiss/G (KB.I170A.168)
AS5820TG - 434G50Mn	3rd WiFi 2x2 BGN	BT 2.1	6CELL3.0	90W	Russian (KB.I170A.164)
AS5820TG - 434G50Mn	3rd WiFi 2x2 BGN	BT 2.1	6CELL3.0	90W	Russian (KB.I170A.164)
AS5820TG - 434G50Mn	3rd WiFi 2x2 BGN	BT 2.1	6CELL3.0	90W	US International (KB.I170A.172)
AS5820TG - 434G50Mn	3rd WiFi 2x2 BGN	BT 2.1	6CELL3.0	90W	UK (KB.I170A.171)
AS5820TG - 434G50Mn	3rd WiFi 2x2 BGN	BT 2.1	6CELL3.0	90W	CZ/SK (KB.I170A.150)
AS5820TG - 434G50Mn	3rd WiFi 2x2 BGN	BT 2.1	6CELL3.0	90W	Hungarian (KB.I170A.157)
AS5820TG - 434G50Mn	3rd WiFi 2x2 BGN	BT 2.1	6CELL3.0	90W	US International w/ Hebrew (KB.I170A.173)

Model	Wireless LAN1	Bluetooth	Battery	Adapter	K/B
AS5820TG - 434G50Mn	3rd WiFi 2x2 BGN	BT 2.1	6CELL3.0	90W	Russian (KB.I170A.164)
AS5820TG - 434G50Mn	3rd WiFi 2x2 BGN	BT 2.1	6CELL3.0	90W	Italian (KB.I170A.158)
AS5820TG - 434G50Mn	3rd WiFi 2x2 BGN	BT 2.1	6CELL3.0	90W	Spanish (KB.I170A.166)
AS5820TG - 434G50Mn	3rd WiFi 2x2 BGN	BT 2.1	6CELL3.0	90W	Greek (KB.I170A.156)
AS5820TG - 434G50Mn	3rd WiFi 2x2 BGN	BT 2.1	6CELL3.0	90W	German (KB.I170A.155)
AS5820TG - 434G50Mn	3rd WiFi 2x2 BGN	BT 2.1	6CELL3.0	90W	SLO/CRO (KB.I170A.165)
AS5820TG - 434G50Mn	3rd WiFi 2x2 BGN	BT 2.1	6CELL3.0	90W	French (KB.I170A.154)
AS5820TG - 434G50Mn	3rd WiFi 2x2 BGN	BT 2.1	6CELL3.0	90W	UK (KB.I170A.171)
AS5820TG - 434G50Mn	3rd WiFi 2x2 BGN	BT 2.1	6CELL3.0	90W	Portuguese (KB.I170A.163)
AS5820TG - 434G50Mn	3rd WiFi 2x2 BGN	BT 2.1	6CELL3.0	90W	Sweden (KB.I170A.167)
AS5820TG - 434G50Mn	3rd WiFi 2x2 BGN	BT 2.1	6CELL3.0	90W	SLO/CRO (KB.I170A.165)
AS5820TG - 434G50Mn	3rd WiFi 2x2 BGN	BT 2.1	6CELL3.0	90W	SLO/CRO (KB.I170A.165)
AS5820TG - 434G50Mn	3rd WiFi 2x2 BGN	BT 2.1	6CELL3.0	90W	Sweden (KB.I170A.167)
AS5820TG - 434G32Mn	3rd WiFi 2x2 BGN	BT 2.1	6CELL3.0	90W	US International (KB.I170A.172)
AS5820TG - 524G50Mn	3rd WiFi 2x2 BGN	BT 2.1	9CELL3.0	90W	UK (KB.I170A.171)
AS5820TG - 524G50Mn	3rd WiFi 2x2 BGN	BT 2.1	6CELL3.0	90W	US International (KB.I170A.172)
AS5820TG - 434G25Mn	3rd WiFi 2x2 BGN	BT 2.1	6CELL3.0	90W	US International (KB.I170A.172)

Model	Wireless LAN1	Bluetooth	Battery	Adapter	K/B
AS5820TG - 522G50Mn	3rd WiFi 2x2 BGN	BT 2.1	6CELL3.0	90W	US International (KB.I170A.172)
AS5820TG - 524G25Mn	3rd WiFi 2x2 BGN	BT 2.1	6CELL3.0	90W	US International (KB.I170A.172)
AS5820T- 334G32Mn	3rd WiFi 2x2 BGN	BT 2.1	6CELL3.0	65W	Nordic (KB.I170A.161)
AS5820T- 333G32Mn	3rd WiFi 2x2 BGN	BT 2.1	6CELL3.0	65W	Russian (KB.I170A.164)
AS5820T- 333G32Mi	3rd WiFi BG	BT 2.1	6CELL3.0	65W	Russian (KB.I170A.164)
AS5820T- 333G32Mn	3rd WiFi 2x2 BGN	BT 2.1	6CELL3.0	65W	Russian (KB.I170A.164)
AS5820T- 333G32Mn	3rd WiFi 2x2 BGN	BT 2.1	6CELL3.0	65W	Arabic (KB.I170A.147)
AS5820T- 333G32Mn	3rd WiFi 2x2 BGN	BT 2.1	6CELL3.0	65W	Turkish (KB.I170A.170)
AS5820T- 333G32Mn	3rd WiFi 2x2 BGN	BT 2.1	6CELL3.0	65W	US International (KB.I170A.172)
AS5820T- 333G32Mn	3rd WiFi 2x2 BGN	BT 2.1	6CELL3.0	65W	Arabic (KB.I170A.147)
AS5820T- 333G32Mn	3rd WiFi 2x2 BGN	BT 2.1	6CELL3.0	65W	Arabic (KB.I170A.147)
AS5820T- 333G32Mn	3rd WiFi 2x2 BGN	BT 2.1	6CELL3.0	65W	US International (KB.I170A.172)
AS5820T- 333G32Mn	3rd WiFi 2x2 BGN	BT 2.1	6CELL3.0	65W	FR/Arabic (KB.I170A.153)
AS5820T- 333G32Mn	3rd WiFi 2x2 BGN	BT 2.1	6CELL3.0	65W	FR/Arabic (KB.I170A.153)
AS5820T- 333G32Mn	3rd WiFi 2x2 BGN	BT 2.1	6CELL3.0	65W	French (KB.I170A.154)
AS5820T- 333G32Mn	3rd WiFi 2x2 BGN	BT 2.1	6CELL3.0	65W	Russian (KB.I170A.164)
AS5820T- 333G32Mn	3rd WiFi 2x2 BGN	BT 2.1	6CELL3.0	65W	Arabic (KB.I170A.147)
AS5820T- 333G32Mn	3rd WiFi 2x2 BGN	BT 2.1	6CELL3.0	65W	French (KB.I170A.154)
AS5820T- 333G32Mn	3rd WiFi 2x2 BGN	BT 2.1	6CELL3.0	65W	US International (KB.I170A.172)
AS5820T- 333G32Mn	3rd WiFi 2x2 BGN	BT 2.1	6CELL3.0	65W	US International (KB.I170A.172)
AS5820T- 333G32Mn	3rd WiFi 2x2 BGN	BT 2.1	6CELL3.0	65W	German (KB.I170A.155)
AS5820T- 333G32Mn	3rd WiFi 2x2 BGN	BT 2.1	6CELL3.0	65W	US International (KB.I170A.172)
AS5820T- 333G32Mn	3rd WiFi 2x2 BGN	BT 2.1	6CELL3.0	65W	US International (KB.I170A.172)
AS5820T- 333G32Mn	3rd WiFi 2x2 BGN	BT 2.1	6CELL3.0	65W	US International (KB.I170A.172)

Model	Wireless LAN1	Bluetooth	Battery	Adapter	K/B
AS5820T-333G32Mn	3rd Wi-Fi 2x2 BGN	BT 2.1	6CELL3.0	65W	Belgium (KB.I170A.148)
AS5820T-333G32Mn	3rd Wi-Fi 2x2 BGN	BT 2.1	6CELL3.0	65W	Swiss/G (KB.I170A.168)
AS5820T-333G32Mn	3rd Wi-Fi 2x2 BGN	BT 2.1	6CELL3.0	65W	Swiss/G (KB.I170A.168)
AS5820T-333G32Mn	3rd Wi-Fi 2x2 BGN	BT 2.1	6CELL3.0	65W	Russian (KB.I170A.164)
AS5820T-333G32Mn	3rd Wi-Fi 2x2 BGN	BT 2.1	6CELL3.0	65W	Russian (KB.I170A.164)
AS5820T-333G32Mn	3rd Wi-Fi 2x2 BGN	BT 2.1	6CELL3.0	65W	UK (KB.I170A.171)
AS5820T-333G32Mn	3rd Wi-Fi 2x2 BGN	BT 2.1	6CELL3.0	65W	US International (KB.I170A.172)
AS5820T-333G32Mn	3rd Wi-Fi 2x2 BGN	BT 2.1	6CELL3.0	65W	US International (KB.I170A.172)
AS5820T-333G32Mn	3rd Wi-Fi 2x2 BGN	BT 2.1	6CELL3.0	65W	CZ/SK (KB.I170A.150)
AS5820T-333G32Mn	3rd Wi-Fi 2x2 BGN	BT 2.1	6CELL3.0	65W	Hungarian (KB.I170A.157)
AS5820T-333G32Mn	3rd Wi-Fi 2x2 BGN	BT 2.1	6CELL3.0	65W	US International w/ Hebrew (KB.I170A.173)
AS5820T-333G32Mn	3rd Wi-Fi 2x2 BGN	BT 2.1	6CELL3.0	65W	Russian (KB.I170A.164)
AS5820T-333G32Mn	3rd Wi-Fi 2x2 BGN	BT 2.1	6CELL3.0	65W	Portuguese (KB.I170A.163)
AS5820T-333G32Mn	3rd Wi-Fi 2x2 BGN	BT 2.1	6CELL3.0	65W	UK (KB.I170A.171)
AS5820T-333G32Mn	3rd Wi-Fi 2x2 BGN	BT 2.1	6CELL3.0	65W	Sweden (KB.I170A.167)
AS5820T-333G32Mn	3rd Wi-Fi 2x2 BGN	BT 2.1	6CELL3.0	65W	SLO/CRO (KB.I170A.165)
AS5820T-333G32Mn	3rd Wi-Fi 2x2 BGN	BT 2.1	6CELL3.0	65W	Italian (KB.I170A.158)
AS5820T-333G32Mn	3rd Wi-Fi 2x2 BGN	BT 2.1	6CELL3.0	65W	Spanish (KB.I170A.166)
AS5820T-333G32Mn	3rd Wi-Fi 2x2 BGN	BT 2.1	6CELL3.0	65W	Nordic (KB.I170A.161)
AS5820T-333G32Mn	3rd Wi-Fi 2x2 BGN	BT 2.1	6CELL3.0	65W	SLO/CRO (KB.I170A.165)
AS5820T-333G32Mn	3rd Wi-Fi 2x2 BGN	BT 2.1	6CELL3.0	65W	Sweden (KB.I170A.167)
AS5820T-333G32Mn	3rd Wi-Fi 2x2 BGN	BT 2.1	6CELL3.0	65W	Greek (KB.I170A.156)
AS5820T-333G32Mn	3rd Wi-Fi 2x2 BGN	BT 2.1	6CELL3.0	65W	German (KB.I170A.155)
AS5820T-333G32Mn	3rd Wi-Fi 2x2 BGN	BT 2.1	6CELL3.0	65W	French (KB.I170A.154)
AS5820T-333G32Mn	3rd Wi-Fi 2x2 BGN	BT 2.1	6CELL3.0	65W	SLO/CRO (KB.I170A.165)

Model	Wireless LAN1	Bluetooth	Battery	Adapter	K/B
AS5820T-334G32Mn	3rd WiFi 2x2 BGN	N	6CELL3.0	65W	Italian (KB.I170A.158)
AS5820T-334G50Mn	3rd WiFi 2x2 BGN	N	6CELL3.0	65W	Spanish (KB.I170A.166)
AS5820T-434G50Mn	3rd WiFi 2x2 BGN	BT 2.1	6CELL3.0	65W	US International (KB.I170A.172)
AS5820T-434G32Mn	3rd WiFi 2x2 BGN	BT 2.1	6CELL3.0	65W	US International (KB.I170A.172)
AS5820T-334G50Mn	3rd WiFi 2x2 BGN	N	6CELL3.0	65W	US International (KB.I170A.172)
AS5820T-334G32Mn	3rd WiFi 2x2 BGN	N	6CELL3.0	65W	US International (KB.I170A.172)
AS5820T-334G32Mn	3rd WiFi 2x2 BGN	BT 2.1	6CELL3.0	65W	Russian (KB.I170A.164)
AS5820T-334G32Mi	3rd WiFi BG	BT 2.1	6CELL3.0	65W	Russian (KB.I170A.164)
AS5820T-334G32Mn	3rd WiFi 2x2 BGN	BT 2.1	6CELL3.0	65W	Russian (KB.I170A.164)
AS5820T-334G32Mn	3rd WiFi 2x2 BGN	BT 2.1	6CELL3.0	65W	Arabic (KB.I170A.147)
AS5820T-334G32Mn	3rd WiFi 2x2 BGN	BT 2.1	6CELL3.0	65W	US International (KB.I170A.172)
AS5820T-334G32Mn	3rd WiFi 2x2 BGN	BT 2.1	6CELL3.0	65W	Turkish (KB.I170A.170)
AS5820T-334G32Mn	3rd WiFi 2x2 BGN	BT 2.1	6CELL3.0	65W	Arabic (KB.I170A.147)
AS5820T-334G32Mn	3rd WiFi 2x2 BGN	BT 2.1	6CELL3.0	65W	Arabic (KB.I170A.147)
AS5820T-334G32Mn	3rd WiFi 2x2 BGN	BT 2.1	6CELL3.0	65W	FR/Arabic (KB.I170A.153)
AS5820T-334G32Mn	3rd WiFi 2x2 BGN	BT 2.1	6CELL3.0	65W	FR/Arabic (KB.I170A.153)
AS5820T-334G32Mn	3rd WiFi 2x2 BGN	BT 2.1	6CELL3.0	65W	French (KB.I170A.154)
AS5820T-334G32Mn	3rd WiFi 2x2 BGN	BT 2.1	6CELL3.0	65W	Russian (KB.I170A.164)
AS5820T-334G32Mn	3rd WiFi 2x2 BGN	BT 2.1	6CELL3.0	65W	Arabic (KB.I170A.147)
AS5820T-334G32Mn	3rd WiFi 2x2 BGN	BT 2.1	6CELL3.0	65W	French (KB.I170A.154)
AS5820T-334G32Mn	3rd WiFi 2x2 BGN	BT 2.1	6CELL3.0	65W	US International (KB.I170A.172)
AS5820T-334G32Mn	3rd WiFi 2x2 BGN	BT 2.1	6CELL3.0	65W	US International (KB.I170A.172)
AS5820T-334G32Mn	3rd WiFi 2x2 BGN	BT 2.1	6CELL3.0	65W	US International (KB.I170A.172)
AS5820T-334G32Mn	3rd WiFi 2x2 BGN	BT 2.1	6CELL3.0	65W	German (KB.I170A.155)
AS5820T-334G32Mn	3rd WiFi 2x2 BGN	BT 2.1	6CELL3.0	65W	US International (KB.I170A.172)

Model	Wireless LAN1	Bluetooth	Battery	Adapter	K/B
AS5820T-334G32Mn	3rd Wi-Fi 2x2 BGN	BT 2.1	6CELL3.0	65W	Swiss/G (KB.I170A.168)
AS5820T-334G32Mn	3rd Wi-Fi 2x2 BGN	BT 2.1	6CELL3.0	65W	US International (KB.I170A.172)
AS5820T-334G32Mn	3rd Wi-Fi 2x2 BGN	BT 2.1	6CELL3.0	65W	Belgium (KB.I170A.148)
AS5820T-334G32Mn	3rd Wi-Fi 2x2 BGN	BT 2.1	6CELL3.0	65W	Swiss/G (KB.I170A.168)
AS5820T-334G32Mn	3rd Wi-Fi 2x2 BGN	BT 2.1	6CELL3.0	65W	Russian (KB.I170A.164)
AS5820T-334G32Mn	3rd Wi-Fi 2x2 BGN	BT 2.1	6CELL3.0	65W	Russian (KB.I170A.164)
AS5820T-334G32Mn	3rd Wi-Fi 2x2 BGN	BT 2.1	6CELL3.0	65W	US International (KB.I170A.172)
AS5820T-334G32Mn	3rd Wi-Fi 2x2 BGN	BT 2.1	6CELL3.0	65W	US International (KB.I170A.172)
AS5820T-334G32Mn	3rd Wi-Fi 2x2 BGN	BT 2.1	6CELL3.0	65W	UK (KB.I170A.171)
AS5820T-334G32Mn	3rd Wi-Fi 2x2 BGN	BT 2.1	6CELL3.0	65W	CZ/SK (KB.I170A.150)
AS5820T-334G32Mn	3rd Wi-Fi 2x2 BGN	BT 2.1	6CELL3.0	65W	Hungarian (KB.I170A.157)
AS5820T-334G32Mn	3rd Wi-Fi 2x2 BGN	BT 2.1	6CELL3.0	65W	US International w/ Hebrew (KB.I170A.173)
AS5820T-334G32Mn	3rd Wi-Fi 2x2 BGN	BT 2.1	6CELL3.0	65W	Russian (KB.I170A.164)
AS5820T-334G32Mn	3rd Wi-Fi 2x2 BGN	BT 2.1	6CELL3.0	65W	UK (KB.I170A.171)
AS5820T-334G32Mn	3rd Wi-Fi 2x2 BGN	BT 2.1	6CELL3.0	65W	Portuguese (KB.I170A.163)
AS5820T-334G32Mn	3rd Wi-Fi 2x2 BGN	BT 2.1	6CELL3.0	65W	Sweden (KB.I170A.167)
AS5820T-334G32Mn	3rd Wi-Fi 2x2 BGN	BT 2.1	6CELL3.0	65W	SLO/CRO (KB.I170A.165)
AS5820T-334G32Mn	3rd Wi-Fi 2x2 BGN	BT 2.1	6CELL3.0	65W	SLO/CRO (KB.I170A.165)
AS5820T-334G32Mn	3rd Wi-Fi 2x2 BGN	BT 2.1	6CELL3.0	65W	Sweden (KB.I170A.167)
AS5820T-334G32Mn	3rd Wi-Fi 2x2 BGN	BT 2.1	6CELL3.0	65W	Italian (KB.I170A.158)
AS5820T-334G32Mn	3rd Wi-Fi 2x2 BGN	BT 2.1	6CELL3.0	65W	Spanish (KB.I170A.166)
AS5820T-334G32Mn	3rd Wi-Fi 2x2 BGN	BT 2.1	6CELL3.0	65W	Greek (KB.I170A.156)
AS5820T-334G32Mn	3rd Wi-Fi 2x2 BGN	BT 2.1	6CELL3.0	65W	German (KB.I170A.155)
AS5820T-334G32Mn	3rd Wi-Fi 2x2 BGN	BT 2.1	6CELL3.0	65W	SLO/CRO (KB.I170A.165)
AS5820T-334G32Mn	3rd Wi-Fi 2x2 BGN	BT 2.1	6CELL3.0	65W	French (KB.I170A.154)

Model	Wireless LAN1	Bluetooth	Battery	Adapter	K/B
AS5820T-432G32Mn	3rd WiFi 2x2 BGN	BT 2.1	6CELL3.0	65W	US International (KB.I170A.172)
AS5820T-434G50Mn	3rd WiFi 2x2 BGN	BT 2.1	9CELL3.0	65W	UK (KB.I170A.171)
AS5820T-333G32Mn	3rd WiFi 2x2 BGN	N	6CELL3.0	65W	UK (KB.I170A.171)
AS5820T-332G16Mn	3rd WiFi 2x2 BGN	N	6CELL3.0	65W	US International (KB.I170A.172)
AS5820T-522G16Mn	3rd WiFi 2x2 BGN	BT 2.1	6CELL3.0	65W	US International (KB.I170A.172)
AS5820T-524G16Mn	3rd WiFi 2x2 BGN	BT 2.1	6CELL3.0	65W	US International (KB.I170A.172)

Test Compatible Components

This computer's compatibility is tested and verified by Acer's internal testing department. All of its system functions are tested under Windows® 7 environment.

Refer to the following lists for components, adapter cards, and peripherals which have passed these tests. Regarding configuration, combination and test procedures, please refer to the Compatibility Test Report released by the Acer Mobile System Testing Department.

BRAND	Type	Description
3G		
	EM770W-Rev1	EM770W-Rev1
Ericsson	F3307-900MHz	Ericsson F3307-900MHz
A cover		
	Aluminum	Aluminum
Adapter		
Chicony Power	65W	Adapter Chicony Power 65W 19V 1.7x5.5x11 Yellow CPA09-A065N1, LV5, low profile LED LF
DELTA	65W	Adapter DELTA 65W 19V 1.7x5.5x11 Yellow ADP-65JH DB A, LV5 LED LF
DELTA	65W	Adapter DELTA 65W 19V 1.7x5.5x11 Yellow ADP-65VH BA, LV5, Low profile LED LF
HIPRO	65W	Adapter HIPRO 65W 19V 1.7x5.5x11 Yellow HP-A0652R3B 1LF, LV5 LED LF
LITE-ON	65W	Adapter LITE-ON 65W 19V 1.7x5.5x11 Yellow PA-1650-22AC LV5 LED LF
LITE-ON	65W	Adapter LITE-ON 65W 19V 1.7x5.5x11 Yellow PA-1650-69AW, LV5, Low profile LED LF
DELTA	90W	Adapter DELTA 90W 19V 1.7x5.5x11 Blue ADP-90CD DB A, LV5 LED LF
HIPRO	90W	Adapter HIPRO 90W 19V 1.7x5.5x11 Blue HP-A0904A3 B1LF, LV5 LED LF
LITE-ON	90W	Adapter LITE-ON 90W 19V 1.7x5.5x11 Blue PA-1900-34AR, LV5 LED LF
Audio Codec		
Realtek	ALC271X	Realtek ALC271X
B cover		
	Mirror w/Camera	Mirror w/Camera
Battery		
PANASONIC	6CELL3.0	Battery PANASONIC AS10B Li-Ion 3S2P PANASONIC 6 cell 6000mAh Main COMMON ID:AS10B5E
SAMSUNG	6CELL3.0	Battery SAMSUNG AS10B Li-Ion 3S2P SAMSUNG 6 cell 6000mAh Main COMMON ID:AS10B6E
SANYO	6CELL3.0	Battery SANYO AS10B Li-Ion 3S2P SANYO 6 cell 6000mAh Main COMMON ID: AS10B3E

BRAND	Type	Description
SIMPLO	6CELL3.0	Battery SIMPLO AS10B Li-Ion 3S2P SAMSUNG 6 cell 6000mAh Main COMMON ID:AS10B7E
SIMPLO	9CELL3.0	Battery SIMPLO AS10E Li-Ion 3S3P SAMSUNG 9 cell 9000mAh Main COMMON ID:AS10E7E
Foxconn	BT 2.1	Foxconn Bluetooth BRM 2046 BT2.1 (T60H928.33) f/w:861
Camera		
Chicony	1.3M	Chicony 1.3M CH9665SN (CNF9157)
Liteon	1.3M	Liteon 1.3M LT6AASP(09P2BF127)
Liteon	1.3M	Liteon 1.3M LT9665AL (09P2SF119)
Suyin	1.3M	Suyin 1.3M SY9665SN
Card Reader		
	5 in 1-Build in	5 in 1-Build in MS, MS Pro, SD, SC, XD
CPU		
INTEL	Ci3330M	CPU Intel Core i3 330M PGA 2.13G 35W Arrandale, TJ90, VT, 3M L3
INTEL	Ci3350M	CPU Intel Core i3 350M PGA 2.26G 35W Arrandale, TJ90, VT, 3M L3
INTEL	Ci3350M	CPU Intel Core i3 350M PGA 2.26G 35W K-0 TJ90, VT
INTEL	Ci5430M	CPU Intel Core i5 430M PGA 2.26G ARD, up to SC 2.53G, 3M L3
INTEL	Ci5520M	CPU Intel Core i5 520M 2.4G
INTEL	Ci5540M	CPU Intel Core i5 540M 2.53G 3M
INTEL	Ci7620M	CPU Intel Core i7 620M PGA 2.66G
HDD		
HGST	N160GB5.4KS	HDD HGST 2.5" 5400rpm 160GB HTS545016B9A300 Panther B SATA LF F/W:C60F Disk imbalance criteria = 0.014g-cm
SEAGATE	N160GB5.4KS	HDD SEAGATE 2.5" 5400rpm 160GB ST9160314AS Wyatt SATA LF F/W:0001SDM1
SEAGATE	N160GB5.4KS	HDD SEAGATE 2.5" 5400rpm 160GB ST9160314AS,9HH13C-189, Seagate(new pcb) SATA 8MB LF F/W:0001SDM1
TOSHIBA	N160GB5.4KS	HDD TOSHIBA 2.5" 5400rpm 160GB MK1665GSX, Capricorn BS, 320G/P SATA 8MB LF F/W:GJ002J
WD	N160GB5.4KS	HDD WD 2.5" 5400rpm 160GB WD1600BEVT-22A23T0 , WD, ML320S SATA 8MB LF F/W:01.01A01
HGST	N250GB5.4KS	HDD HGST 2.5" 5400rpm 250GB HTS545025B9A300 Panther B SATA LF F/W:C60F Disk imbalance criteria = 0.014g-cm
SEAGATE	N250GB5.4KS	HDD SEAGATE 2.5" 5400rpm 250GB ST9250315AS Wyatt SATA LF F/W:0001SDM1
SEAGATE	N250GB5.4KS	HDD SEAGATE 2.5" 5400rpm 250GB ST9250315AS, 9HH132-189, Wyatt with new pcb SATA 8MB LF F/W:0001SDM1
TOSHIBA	N250GB5.4KS	HDD TOSHIBA 2.5" 5400rpm 250GB MK2565GSX, Capricorn BS, 320G/P SATA 8MB LF F/W:GJ002J
WD	N250GB5.4KS	HDD WD 2.5" 5400rpm 250GB WD2500BEVT-22A23T0, WD, ML320S SATA 8MB LF F/W:01.01A01.

BRAND	Type	Description
HGST	N320GB5.4KS	HDD HGST 2.5" 5400rpm 320GB HTS545032B9A300 Panther B SATA LF F/W:C60F Disk imbalance criteria = 0.014g-cm
SEAGATE	N320GB5.4KS	HDD SEAGATE 2.5" 5400rpm 320GB ST9320325AS Wyatt SATA LF F/W:0001SDM1
SEAGATE	N320GB5.4KS	HDD SEAGATE 2.5" 5400rpm 320GB ST9320325AS, 9HH13E-189, Wyatt with new pcb SATA 8MB LF F/W:0001SDM1
TOSHIBA	N320GB5.4KS	HDD TOSHIBA 2.5" 5400rpm 320GB Capricorn BS ,MK3265GSX SATA 8MB LF F/W:GJ002J
WD	N320GB5.4KS	HDD WD 2.5" 5400rpm 320GB WD3200BEVT-22A23T0,ML320S,WD SATA 8MB LF F/W:01.01A01
WD	N320GB5.4KS	HDD WD 2.5" 5400rpm 320GB WD3200BEVT-22ZCT0 ML160 SATA LF F/W:11.01A11
HGST	N500GB5.4KS	HDD HGST 2.5" 5400rpm 500GB HTS545050B9A300 Panther B SATA LF F/W:C60F Disk imbalance criteria = 0.014g-cm
SEAGATE	N500GB5.4KS	HDD SEAGATE 2.5" 5400rpm 500GB ST9500325AS Wyatt SATA LF F/W:0001SDM1
SEAGATE	N500GB5.4KS	HDD SEAGATE 2.5" 5400rpm 500GB ST9500325AS,9HH134-189, Wyatt with new pcb SATA 8MB LF F/W:0001SDM1
TOSHIBA	N500GB5.4KS	HDD TOSHIBA 2.5" 5400rpm 500GB MK5065GSX,Capricorn BS, 320G/P SATA 8MB LF F/W:GJ002J
WD	N500GB5.4KS	HDD WD 2.5" 5400rpm 500GB WD5000BEVT-22A0RT0, ML320M,WD SATA 8MB LF F/W:01.01A01
TOSHIBA	N640GB5.4KS	HDD TOSHIBA 2.5" 5400rpm 640GB MK6465GSX,Capricorn BS,320G/P SATA 8MB LF F/W:GJ002J
WD	N640GB5.4KS	HDD WD 2.5" 5400rpm 640GB WD6400BEVT-22A0RT0, ML320 SATA 8MB LF F/W:01.01A01
INTEL	SSD25160	Flash Disk INTEL SSD NAND 160GB SSSDA2MH160G2AC MM#908113 9.5mm LF+HF
ACER	AC7T_A10B	Keyboard ACER AC7T_A10B AC7T Internal 17 Standard Black NONE Y2010 Acer Texture
LAN		
Atheros	AR8151L	Atheros AR8151L
LCD		
AUO	NLED15.6WXGAGS	LED LCD AUO 15.6"W WXGA Glare B156XW03 V1 LF 220nit 8ms 500:1
AUO	NLED15.6WXGAGS	LED LCD AUO 15.6"W WXGA Glare B156XW04 V0 LF 200nit 8ms 400:1 (Power saving)
CMO	NLED15.6WXGAGS	LED LCD CMO 15.6"W WXGA Glare N156B6-L0D LF 200nit 10ms 500:1
LPL	NLED15.6WXGAGS	LED LCD LPL 15.6"W WXGA Glare LP156WH3-TLA2 LF 200nit 8ms 500:1
LPL	NLED15.6WXGAGS	LED LCD LPL 15.6"W WXGA Glare LP156WH3-TLL1 LF 200nit 16ms 500:1 (Power saving)

BRAND	Type	Description
SAMSUNG	NLED15.6WXGAGS	LED LCD SAMSUNG 15.6"W WXGA Glare LTN156AT11-A01 LF 200nit 16ms 500:1 (Power saving)
MEM		
ELPIDA	SO1GBIII10	Memory ELPIDA SO-DIMM DDRIII 1066 1GB EBJ10UE8BDS0-AE-F LF 128*8 0.065um
HYNIX	SO1GBIII10	Memory HYNIX SO-DIMM DDRIII 1066 1GB HMT112S6BFR6C-G7 N0 LF 64*16 0.055um
SAMSUNG	SO1GBIII10	Memory SAMSUNG SO-DIMM DDRIII 1066 1GB M471B2873EH1-CF8 LF 64*16 0.055um
ELPIDA	SO2GBIII10	Memory ELPIDA SO-DIMM DDRIII 1066 2GB EBJ21UE8BDS0-AE-F LF 128*8 0.065um
HYNIX	SO2GBIII10	Memory HYNIX SO-DIMM DDRIII 1066 2GB HMT125S6BFR8C-G7 N0 LF 128*8 0.055um
SAMSUNG	SO2GBIII10	Memory SAMSUNG SO-DIMM DDRIII 1066 2GB M471B5673EH1-CF8 LF 128*8 0.055um
NONE	SO4GBIII10	Memory NONE SO-DIMM DDRIII 1066 4GB dummy P/N LF
NB Chipset		
INTEL	HM55	NB Chipset Intel CS BD82HM55
ODD		
HLDS	NSM8XS9.5	ODD HLDS Super-Multi DRIVE 9.5mm Tray DL 8X GU10N LF W/O bezel SATA (HF + Windows 7)
PANASONIC	NSM8XS9.5	ODD PANASONIC Super-Multi DRIVE 9.5mm Tray DL 8X UJ892 LF W/O bezel SATA GBAS2.0, (HF + Windows7)
TOSHIBA	NSM8XS9.5	ODD TOSHIBA Super-Multi DRIVE 9.5mm Tray DL 8X TS-U633F LF W/O bezel SATA (HF + Windows 7)
Software		
	McAfee	Antivirus application McAfee
VGA Chip		
AMD	MADISON_PRO	AMD MADISON_PRO 40nm 29mm*29mm M2 package
AMD	PARK_XT	AMD PARK_XT 40nm 29mm*29mm M2 package
None	UMA	UMA (Intel)
VRAM		
	1G-DDR3 (64*16*8)	1G-DDR3 64*16*8
	512M-DDR3 (64*16*4)	512M-DDR3 64*16*4
WiFi Antenna		
WNC	PIFA	PIFA
Foxconn	3rd WiFi 2x2 BGN	Foxconn Wireless LAN Atheros HB93 2x2 BGN (HM)
Foxconn	3rd WiFi 2x2 BGN	Foxconn Wireless LAN Atheros HB97 2x2 BGN (HM)
Foxconn	3rd WiFi 2x2 BGN	Foxconn Wireless LAN Broadcomm 43225 2x2 BGN (HM) T77H103.00

Online Support Information

This section describes online technical support services available to help you repair your Acer Systems.

If you are a distributor, dealer, ASP or TPM, please refer your technical queries to your local Acer branch office. Acer Branch Offices and Regional Business Units may access our website. However some information sources will require a user i.d. and password. These can be obtained directly from Acer CSD Taiwan.

Acer's Website offers you convenient and valuable support resources whenever you need them.

In the Technical Information section you can download information on all of Acer's Notebook, Desktop and Server models including:

- Service guides for all models
- User's manuals
- BIOS updates
- Software utilities
- Spare parts lists
- TABs (Technical Announcement Bulletin)

For these purposes, we have included an Acrobat File to facilitate the problem-free downloading of our technical material.

Also contained on this website are:

- Detailed information on Acer's International Traveler's Warranty (ITW)
- Returned material authorization procedures
- An overview of all the support services we offer, accompanied by a list of telephone, fax and email contacts for all your technical queries.

We are always looking for ways to optimize and improve our services, so if you have any suggestions or comments, please do not hesitate to communicate these to us.

A

- Antennas
 - Removing 95, 99

B

- Battery Pack
 - Removing 43
- BIOS
 - ROM type 18
 - vendor 18
- BIOS Utility 23–31
 - Advanced 26
 - Boot 29
 - Exit 30
 - Navigating 23
 - Power 29
 - Save and Exit 30
 - Security 26
 - System Security 30
- brightness
 - hotkeys 13

C

- Camera Board
 - Removing 91, 106
- caps lock
 - on indicator 9
- Common Problems 146
- CPU
 - Replacing 112
- CRT Cable
 - Removing 80

D

- DIMM Module
 - Removing 50
- Display 5
- display
 - hotkeys 13

E

- Euro Key 14
- External Module Disassembly
 - Flowchart 42

F

- Features 1
- FLASH Utility 31
- Flash Utility 31
- FRU (Field Replaceable Unit) List 167

H

- Hard Disk Drive Module
 - Removing 48
- Hibernation mode
 - hotkey 13
- Hot Keys 11

I

- Indicators 9
- Intermittent Problems 156
- Internal Microphone Failure 153
- Internal Speaker Failure 152

J

- Jumper and Connector Locations 163

K

- Keyboard
 - Removing 61
- Keyboard Failure 150

L

- LCD Bezel
 - Removing 89, 107
- LCD Failure 149
- LCD Module
 - Removing 120
- LCD Module Disassembly
 - Flowchart 87
- LCD Panel
 - Removing 92, 104

M

- Main Unit Disassembly
 - Flowchart 58

Mainboard
 Removing 80
media access
 on indicator 9
Memory Check 146
Microphone
 Removing 92, 104
Model Definition 181

N

No Display Issue 147
num lock
 on indicator 9

O

ODD Failure 155
Online Support Information 255

P

Panel 6
PC Card 9
Power On Failure 146

S

Speaker Module
 Removing 78
speakers
 hotkey 13
System
 Block Diagram 5

T

Test Compatible Components 251
Thermal Module
 Removing 82
Touch Pad Failure 151
Troubleshooting
 Built-in KB Failure 150
 Internal Microphone 153
 Internal Speakers 152
 LCD Failure 149
 No Display 147
 ODD 155
 Other Failures 155
 Power On 146
 Touch Pad 151

USB 155

U

Undetermined Problems 156
Upper Cover
 Removing 63
USB Failure (Rightside) 155
utility
 BIOS 23–31

V

volume
 hotkeys 13

W

Windows 2000 Environment Test 251
WLAN Board
 Removing 51